

# HT Series

## Digital Video Recorder

### Manual (Rev.0)

HT-1600 / HT-800 / HT-400 / HTL-400





## WARNING

**RISK OF ELECTRIC SHOCK  
DO NOT OPEN**



**WARNING: TO REDUCE THE RISK OF ELECTRIC SHOCK,  
DO NOT REMOVE COVER (OR BACK).  
NO USER-SERVICEABLE PARTS INSIDE.**



The lightning flash with arrowhead symbol, within an equilateral triangle, is intended to alert the user to the presence of uninsulated "dangerous voltage" within the product's enclosure that may be of sufficient magnitude to constitute a risk of electric shock.



The exclamation point within an equilateral triangle is intended to alert the user to the presence of important operating and Maintenance (servicing) instructions in the literature accompanying the appliance.

### **COMPLIANCE NOTICE OF FCC:**

**THIS EQUIPMENT HAS BEEN TESTED AND FOUND TO COMPLY WITH THE LIMITS FOR A CLASS A DIGITAL DEVICE, PURSUANT TO PART 15 OF THE FCC RULES. THESE LIMITS ARE DESIGNED TO PROVIDE REASONABLE PROTECTION AGAINST HARMFUL INTERFERENCE WHEN THE EQUIPMENT IS OPERATED IN A COMMERCIAL ENVIRONMENT. THIS EQUIPMENT GENERATES, USES, AND CAN RADIATE RADIO FREQUENCY ENERGY AND IF NOT INSTALLED AND USED IN ACCORDANCE WITH THE INSTRUCTION MANUAL, MAY CAUSE HARMFUL INTERFERENCE TO RADIO COMMUNICATIONS. OPERATION OF THIS EQUIPMENT IN A RESIDENTIAL AREA IS LIKELY TO CAUSE HARMFUL INTERFERENCE, IN WHICH CASE USERS WILL BE REQUIRED TO CORRECT THE INTERFERENCE AT THEIR OWN EXPENSE.**

**CAUTION: CHANGES OR MODIFICATIONS NOT EXPRESSLY APPROVED BY THE PARTY RESPONSIBLE FOR COMPLIANCE COULD VOID THE USER'S AUTHORITY TO OPERATE THE EQUIPMENT. THIS CLASS OF DIGITAL APPARATUS MEETS ALL REQUIREMENTS OF THE CANADIAN INTERFERENCE-CAUSING EQUIPMENT REGULATIONS.**

The information in this manual is believed to be accurate as of the date of publication. The information contained herein is subject to change without notice. Revisions or new editions to this publication may be issued to incorporate such changes.

# IMPORTANT SAFEGUARDS

## 1. Read Instructions

All the safety and operating instructions should be read before the appliance is operated.

## 2. Retain Instructions

The safety and operating instructions should be retained for future reference.

## 3. Cleaning

Unplug this equipment from the wall outlet before cleaning it. Do not use liquid aerosol cleaners. Use a damp soft cloth for cleaning.

## 4. Attachments

Never add any attachments and/or equipment without the approval of the manufacturer as such additions may result in the risk of fire, electric shock or other personal injury.

## 5. Water and/or Moisture

Do not use this equipment near water or in contact with water.

## 6. Accessories

Do not place this equipment on an unstable cart, stand or table. The equipment may fall, causing serious injury to a child or adult, and serious damage to the equipment. Wall or shelf mounting should follow the manufacturer's instructions, and should use a mounting kit approved by the manufacturer.

## 7. Power Sources

This equipment should be operated only from the type of power source indicated on the marking label. If you are not sure of the type of power, please consult your equipment dealer or local power company.

## 8. Power Cords

Operator or installer must remove power and TNT connections before handling the equipment.

## 9. Lightning

For added protection for this equipment during a lightning storm, or when it is left unattended and unused for long periods of time, unplug it from the wall outlet and disconnect the antenna or cable system. This will prevent damage to the equipment due to lightning and power-line surges.

## 10. Overloading

Do not overload wall outlets and extension cords as this can result in the risk of fire or electric shock.

## 11. Objects and Liquids

Never push objects of any kind through openings of this equipment as they may touch dangerous voltage points or short out parts that could result in a fire or electric shock. Never spill liquid of any kind on the equipment.

## 12. Servicing

Do not attempt to service this equipment yourself. Refer all servicing to qualified service personnel.

## 13. Damage requiring Service

Unplug this equipment from the wall outlet and refer servicing to qualified service personnel under the following conditions:

- A. When the power-supply cord or the plug has been damaged.
- B. If liquid is spilled, or objects have fallen into the equipment.
- C. If the equipment has been exposed to rain or water.
- D. If the equipment does not operate normally by following the operating instructions, adjust only those controls that are covered by the operating instructions as an improper adjustment of other controls may result in damage and will often require extensive work by a qualified technician to restore the equipment to its normal operation.
- E. If the equipment has been dropped, or the cabinet damaged.
- F. When the equipment exhibits a distinct change in performance — this indicates a need for service.

## 14. Replacement Parts

When replacement parts are required, be sure the service technician has used replacement parts specified by the manufacturer or that have the same characteristics as the original part. Unauthorized substitutions may result in fire, electric shock or other hazards.

## 15. Safety Check

Upon completion of any service or repairs to this equipment, ask the service technician to perform safety checks to determine that the equipment is in proper operating condition.

## 16. Field Installation

This installation should be made by a qualified service person and should conform to all local codes.

## 17. Correct Batteries

Warning: Risk of explosion if battery is replaced by an incorrect type. Dispose of used batteries according to the instructions.

## 18. Tmra

A manufacturer's maximum recommended ambient temperature (Tmra) for the equipment must be specified so that the customer and installer may determine a suitable maximum operating environment for the equipment.

## 19. Elevated Operating Ambient Temperature

If installed in a closed or multi-unit rack assembly, the operating ambient temperature of the rack environment may be greater than room ambient. Therefore, consideration should be given to installing the equipment in an environment compatible with the manufacturer's maximum rated ambient temperature (Tmra).

## 20. Reduced Air Flow

Installation of the equipment in the rack should be such that the amount of airflow required for safe operation of the equipment is not compromised.

## 21. Mechanical Loading

Mounting of the equipment in the rack should be such that a hazardous condition is not caused by uneven mechanical loading.

## 22. Circuit Overloading

Consideration should be given to connection of the equipment to supply circuit and the effect that overloading of circuits might have on over current protection and supply wiring. Appropriate consideration of equipment nameplate ratings should be used when addressing this concern.

## 23. Reliable Earthing (Grounding)

Reliable grounding of rack mounted equipment should be maintained. Particular attention should be given to supply connections other than direct connections to the branch circuit (e.g., use of power strips).

# INDEX

<b>1. SAFETY CAUTIONS</b>	6
1.1 Power Source	6
1.2 Installation	6
1.3 Cleaning and Usage	7
<b>2. OUTLINE</b>	8
2.1 Functions	8
2.2 System Organization	9
<b>3. DVR ORGANIZATION</b>	10
3.1 Front Panel	10
3.2 Real Panel	13
3.3 Remote Controller	15
<b>4. LIVE</b>	16
4.1 Live Screen	16
4.1.1 Top Menu	17
4.1.2 Bottom Menu	17
4.1.3 CAMEO Menu	18
<b>5. SETUP</b>	21
5.1 GENERAL SETUP	21
5.1.1 GENERAL	22
5.1.2 ALARM OUT	24
5.1.3 DISK	24
5.1.4 MONITOR	30
5.1.5 ACCOUT	31
5.1.6 CONFIG	32
5.1.7 SHUTDOWN	33

# INDEX

<b>5.2 CAMERA SETUP</b>	-----	34
5.2.1 CAMERA	-----	34
3.2.2 PTZ	-----	35
5.2.3 SPOT	-----	36
5.2.4 SEQUENCE	-----	37
5.2.5 PRIVATE ZONE	-----	38
<b>5.3 EVENT SETUP</b>	-----	39
5.3.1 MOTION	-----	39
5.3.2 ALARM IN	-----	42
5.3.3 VIDEO LOSS	-----	43
5.3.4 SYSTEM	-----	44
5.3.5 DISPLAY	-----	45
<b>5.4 RECORD SETUP</b>	-----	46
5.4.1 SCHEDULE	-----	46
5.4.2 RECORD	-----	47
5.4.3 EVENT	-----	49
5.4.4 AUDIO	-----	49
5.4.5 MANUAL	-----	49
<b>5.5 ETHERNET SETUP</b>	-----	51
5.5.1 NETWORK	-----	51
5.5.2 SERIAL	-----	54
5.5.3 DDNS	-----	55
5.5.4 E-MAIL	-----	56
<b>5.6 SYSTEM SETUP</b>	-----	57
5.6.1 SYSTEM LOG	-----	57
5.6.2 STATUS	-----	58
5.6.3 VERSION	-----	59

# INDEX

<b>6. SEARCH</b>	60
<b>6.1 Search Screen</b>	61
6.1.1 Search Menu	61
6.1.2 Quick Search	62
6.1.3 Event Search	63
6.1.4 Overlapped List	64
6.1.5 Panorama Search	65
6.1.6 Smart Search	65
6.1.7 Section Repeat Search	65
<b>7. BACKUP</b>	68
7.1 Play with backup data	69
<b>8. APPENDIX</b>	70
8.1 Firmware Upgrade	70
8.2 Web Client	71
8.2.1 Web Viewer Functions	72
8.3 Specification	73
8.4 Trouble Shooting	74

# 1. SAFETY CAUTIONS

- ※ Follow these instructions to keep the user safe and prevent property damage.  
Read them carefully before the use of the product.  
The responsibility falls on the user to install and use the product properly.

## 1.1 Power Source-related

- ① Insert the power plug fully and firmly into the power source.  
– Unstable connection may cause fire.



- ② Do not use a damaged power cord, plug or loose outlet.  
– It may cause electric shock or fire.



- ③ Do not plug several devices exceeding the rated capacity into a single outlet.  
– Abnormal heat generation at the outlet may cause fire.

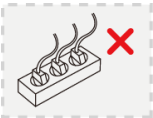

- ④ Do not bend nor pull the power cord. Do not place a heavy object on top of it.  
– It may cause electric shock or fire.

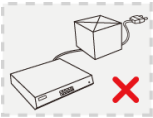

- ⑤ When unplugging the power cord, do not pull it out by touching the cord area or do not touch it with a wet hand.  
– It may cause electric shock or fire.



## 1.2 Installation-related

- ① Do not place candlelight or cigarette light on top of the product or do not install the product near heating devices.  
– It may cause fire.



- ② Do not place the power cord near heating devices.  
– The exterior of the cord may be peeled off, causing electric shock or fire.



- ③ Do not install the product in a place where a large amount of oil, smoke or moisture exists. Do not install the product in a vehicle or a place where water is splashed.  
– It may cause electric shock or fire.



- ④ Do not place the product on top of an unstable cart, stand or table. Do not block the air ventilation with table cloth or curtain.  
– Internal temperature rise may cause fire.



- ⑤ Do not install the product in a narrow place. Keep the product a certain distance away from the wall.  
– Internal temperature rise may cause fire.



### 1.3 Cleaning and Usage-related

- ① Unplug the power plug during lightning, thunderstorm or when not in use for long periods of time.  
- It may cause electric shock or fire.



- ② When taking the battery out from the remote control, keep them away from children to prevent from swallowing incidents.  
Keep the battery away from babies.  
- If a child swallowed the battery, immediately consult a doctor.



- ③ Do not place the container or base filled with water, liquids, chemicals, small piece of metal and heavy object on the product.  
- If liquid flows into the product, it may cause electric shock or fire. A heavy object may drop from the top of the product, causing injury.



- ④ Do not use or store the product near combustible sprays and other flammable substances.  
- It may cause explosion or fire.



- ⑤ If dust or water is present at the power plug's pin and contact area, wipe out the area.  
- may cause electric shock or fire.



- ⑥ When cleaning the product, unplug the power cord and gently wipe using a soft cloth. Do not directly spray water on the product or do not use benzene, thinner or alcohol when cleaning.  
- It may cause electric shock or fire.



- ⑦ When replacing the battery, be sure to check the correctness of the polarity (+,-).  
- If the battery polarity is wrong, generation of abnormal heat or leakage of internal liquid may cause fire, injury or contamination in the surrounding area.



- ⑧ In case the product was dropped or the case was damaged, switch off the product and unplug the power cord. Have a technician repair the product.  
- If the damaged product is used without repair, it may cause electric shock.



- ⑨ Do not repair or disassemble the product by yourself or do not connect other connection devices without the manufacturer's approval.  
- If repair is required, contact the reseller. Failure to follow this instruction may cause electric shock or fire.





# 2. OUTLINE

## 2.1 Functions

This DVR provide Full HD Display and Playback.

- Based on Private Development ASIC Technology and Linux OS.
- Pentaplex Operation Performance (Live, Recording, Playback, Backup, Network)
- 16CH / 8CH / 4CH HD-SDI (SMPTE 292M) Video input.
- 1080P / 720P video compression.
- Various Recording mode. (Manual / Schedule / Event)
- Various Search functions. (Date/Hour search, Calendar search, Event Search)
- Various Playback functions. (Normal / Fast / Slow / Step / Reverse / Smart / Panorama / Repeat)
- Support E-SATA & SATA II
- Digital Zoom in Playback.
- Gigabit Network.
- Support 16channel Audio.
- Support Mouse control.
- E-mail function (Alarm, Motion detection, Video loss, HDD fail end etc)

## 2.2 System Organization

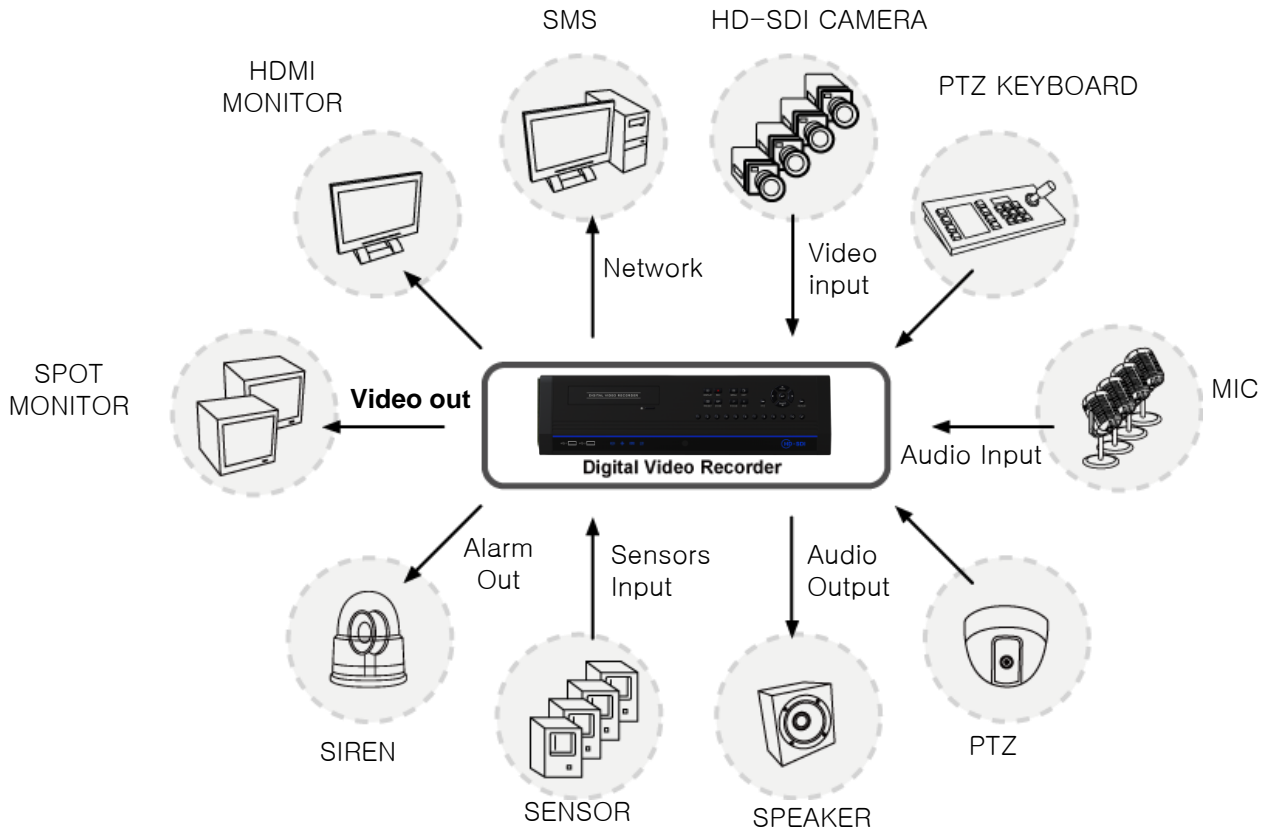

# 3. DVR ORGANIZATION

## 3.1 Front Panel Description

NOTE: Turn on the DVR after connecting the power cord, camera input and monitor completely

### ▪ HT-1600/800/400

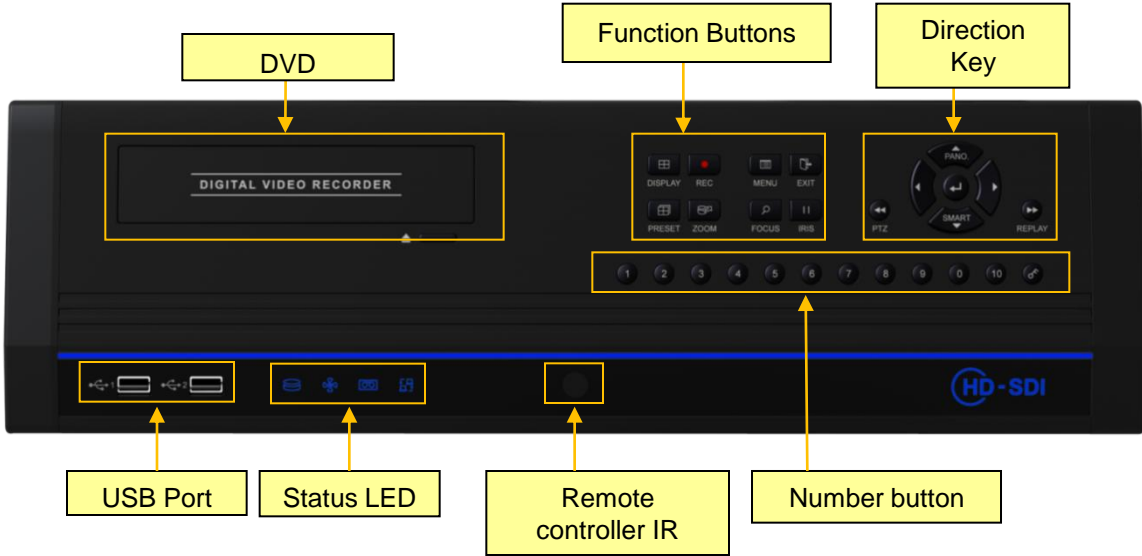

### ▪ HTL-400

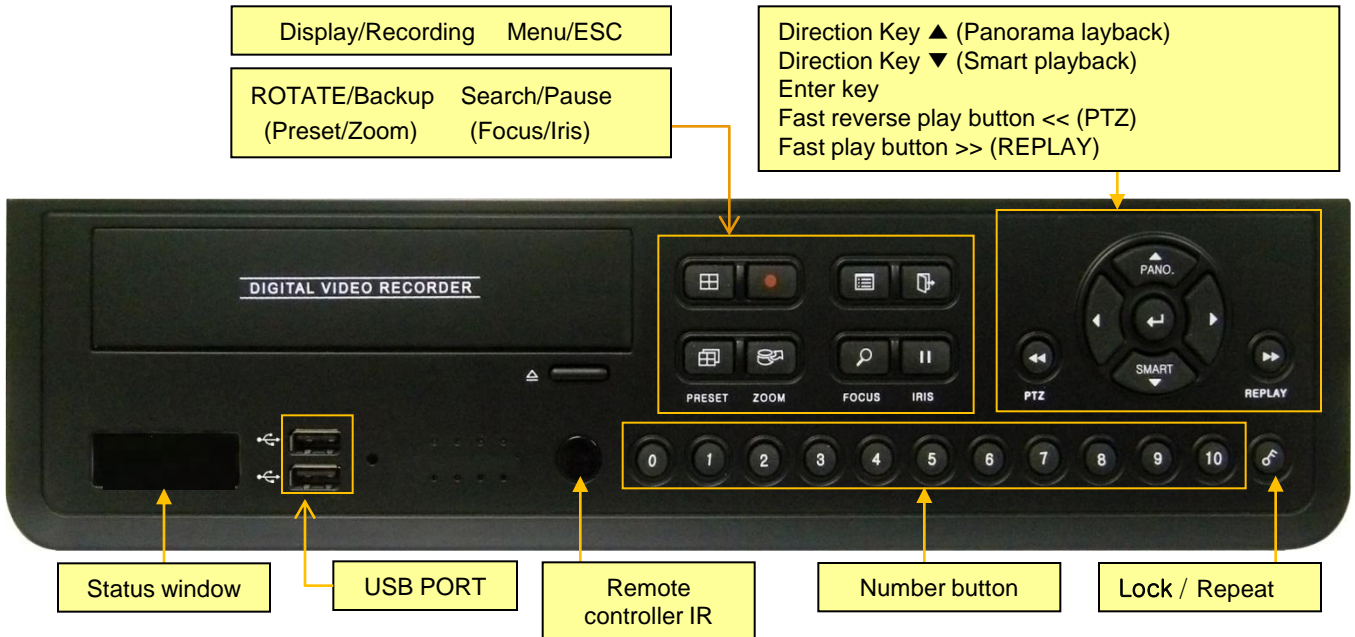

## ※ STATUS LED

### Recording LED

Recording LED is turned on when DVR is recording.

### Network LED

Network LED is turned on when DVR is connected by network

## ※ Front Button

The front panel of DVR is similar as normal VCR or Multiplexer and the functions are also similar . Front buttons have various functions and are used for DVR initial setting and others. Please refer to the below explanation.

### NUMBER buttons (0 ~ 9)

Displayed selected camera number to full screen.  
And also these buttons are used to enter a password.

**NOTE: If user want to use over than 10 channel, use the +10 button.**

Ex)  $10 + 1 = 11$ ,  $10 + 6 = 16$

### DISPLAY button

Display split screens 1, 4, 7, 9, 10, 13, 16.

### REC button

Start recording when this button is pressed in live mode.

### MENU button

Enter Setup menu. User need to Admin access permission.  
Return to previous screen if this button is pressed again.

### ESC button

Exit current screen or return to previous screen.

### ROTATE button (Preset)

Display next channel if this button is pressed.  
In PTZ mode, It is used Preset function button.

## **BACKUP button (Zoom)**

Enter Backup menu. Return to previous screen if this button is pressed again.  
In PTZ mode, it is used Zoom function button.

## **SEARCH button (Focus)**

Enter Search menu. The password is required for search.  
Return to previous screen if this button is pressed again.  
In PTZ menu, it is used Focus function button.

## **PAUSE button (IRIS)**

In Search mode, playback is paused by this button.  
In PTZ mode, it is used IRIS function button.

## **Direction buttons (▲, ▼, ◀, ▶ )**

This buttons are used when move to other menu or change the position of the CAMEO screen.  
In PTZ mode, it is used PAN/TILT function.

- ▲ : In Playback mode, it is Panorama search function button.  
In PTZ mode, it is used to move the camera to up.
- ▼ : In Playback mode, it is Smart search function button.  
In PTZ mode, it is used to move the camera to down.
- ◀ : In Playback mode, it is reverse play button and when paused screen,  
user can see each frame if this button is pressed manually.  
In PTZ mode, it is used to move the camera to left.
- ▶ : In Playback mode, it is forward play button and when paused screen,  
use can see each frame if this button is pressed manually.  
In PTZ mode, it is use to move to camera to right.

**NOTE: For the Smart search, recording data should be recorded by the Event recording.**

**Otherwise, if user try to playback with Smart search, the screen is returned to live mode.**

## **ENTER button**

Execute the selected button or save the setup value.

## **FAST REVERSE PLAY button (PTZ)**

Playback with fast reverse. Playback speed is changed if this button is pressed repeatedly. (◀, ◀◀, ◀◀◀, ◀◀◀◀, ◀◀◀◀◀). In PTZ mode, it is used to Zoom out function button.  
In live mode, switch to PTZ mode by this button.

## **FAST FORWARD PLAY button (PLAY)**

Playback with fast forward. Playback speed is changed if this button is pressed repeatedly. (▶, ▶▶, ▶▶▶, ▶▶▶▶, ▶▶▶▶▶). In PTZ mode, it is used to Zoom in function button.  
In live mode, the last portion of recorded video is played.

# 3.2 Real Panel

▪ HT-1600/800/400

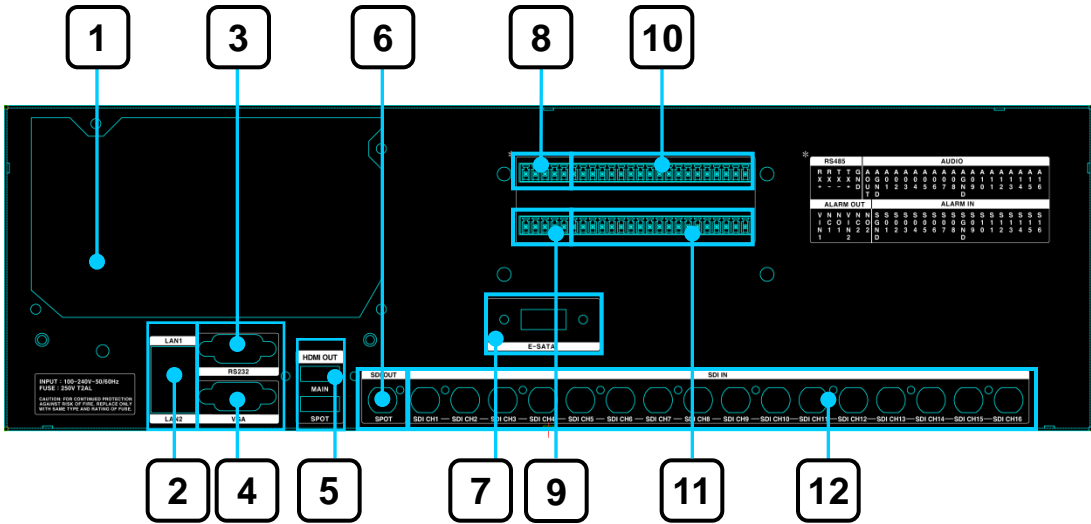

**1**



**Power On/off Switch**

**2**



**Network**

**3**



**RS-232**

**4**



**VGA out**

**5**



**1 HDMI Main out  
1 HDMI Spot out**

**6**



**BNC Spot out**

**7**



**1 e-SATA**

**8**



**RS-485 for PTZ Camera**

**9**



**2 Alarm out**

**10**



**16 Audio in  
1 Audio out**

**11**



**16 Sensor Input**

**12**



**HD-SDI Camera Input X 16**

## 3.2 Real Panel

### ▪ HTL-400

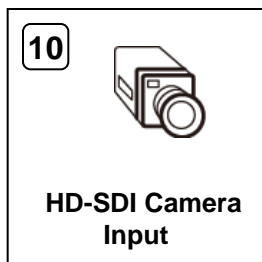
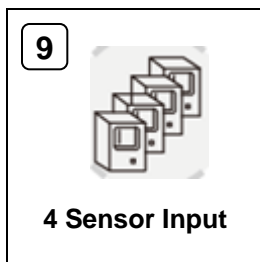
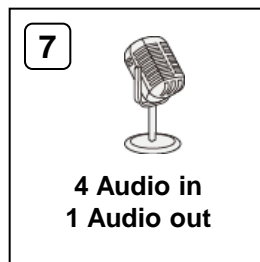
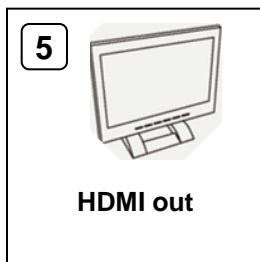
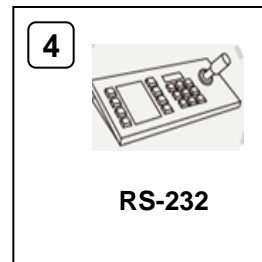
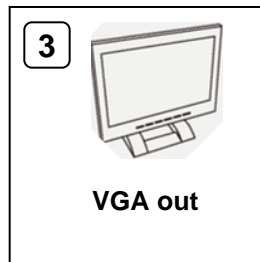
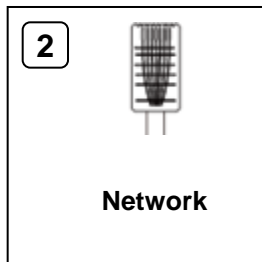
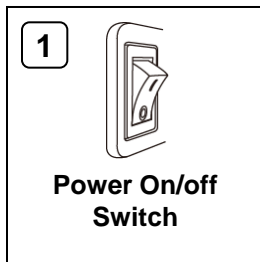
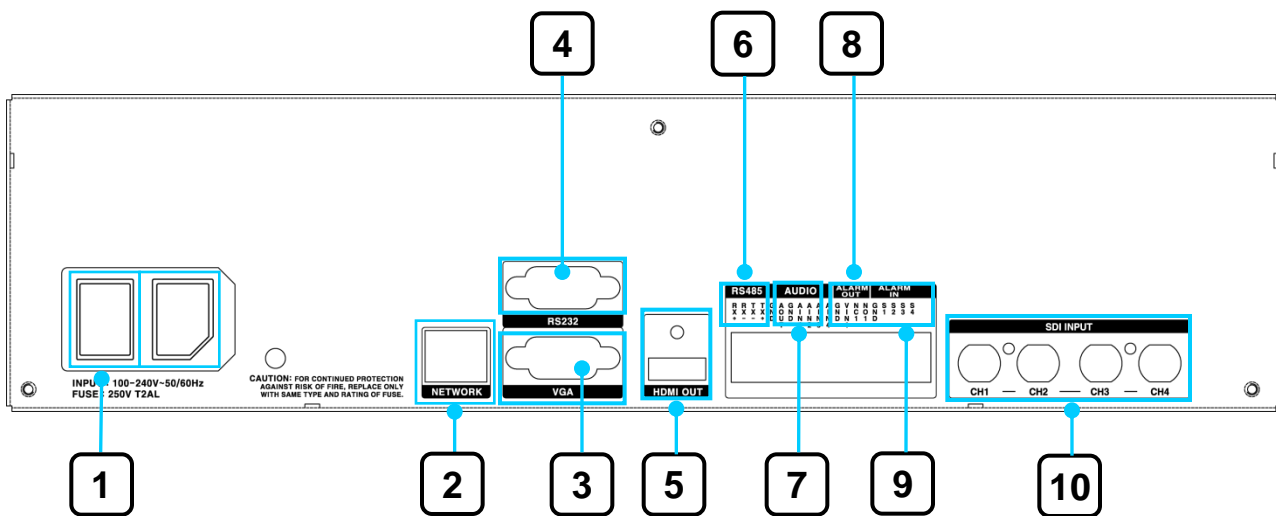

### 3.3 Remote Controller

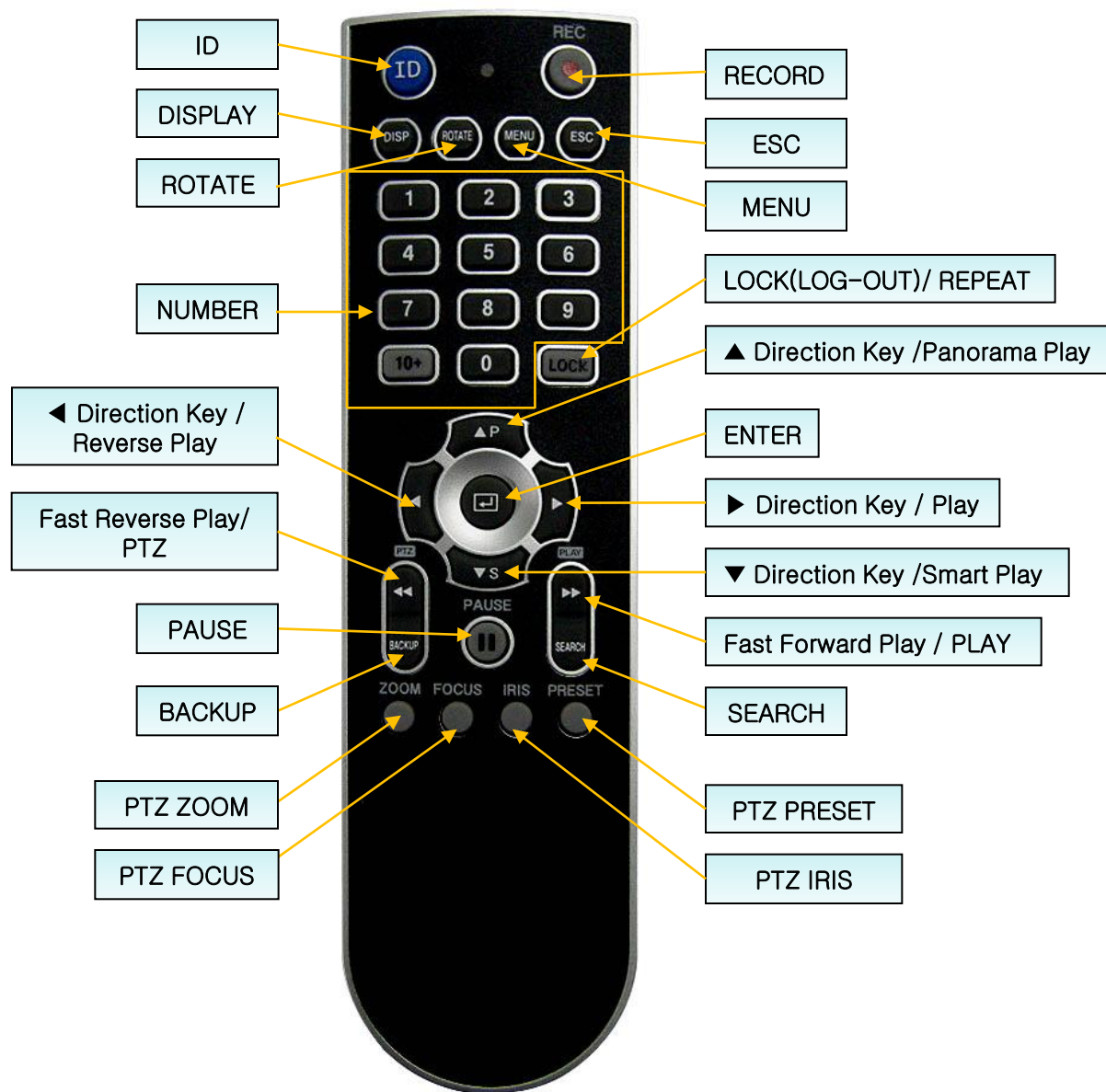

#### ※ How to set ID

- ① Before setup the ID, Enter to the GENERAL SETUP and set the ID first. (Default is 0)
- ② While pressing and holding the ID button, enter the unit address of the DVR by two-digit.
- ③ If the unit address is a single digit, enter two digit number by adding the number 0 as the first digit.  
( Example – If the unit address is 1, the input value is 01.)

※ A single remote controller can change ID from 0 to 19 and independently control up to 20 DVRs.



# 4. LIVE

## 4.1 Live Screen

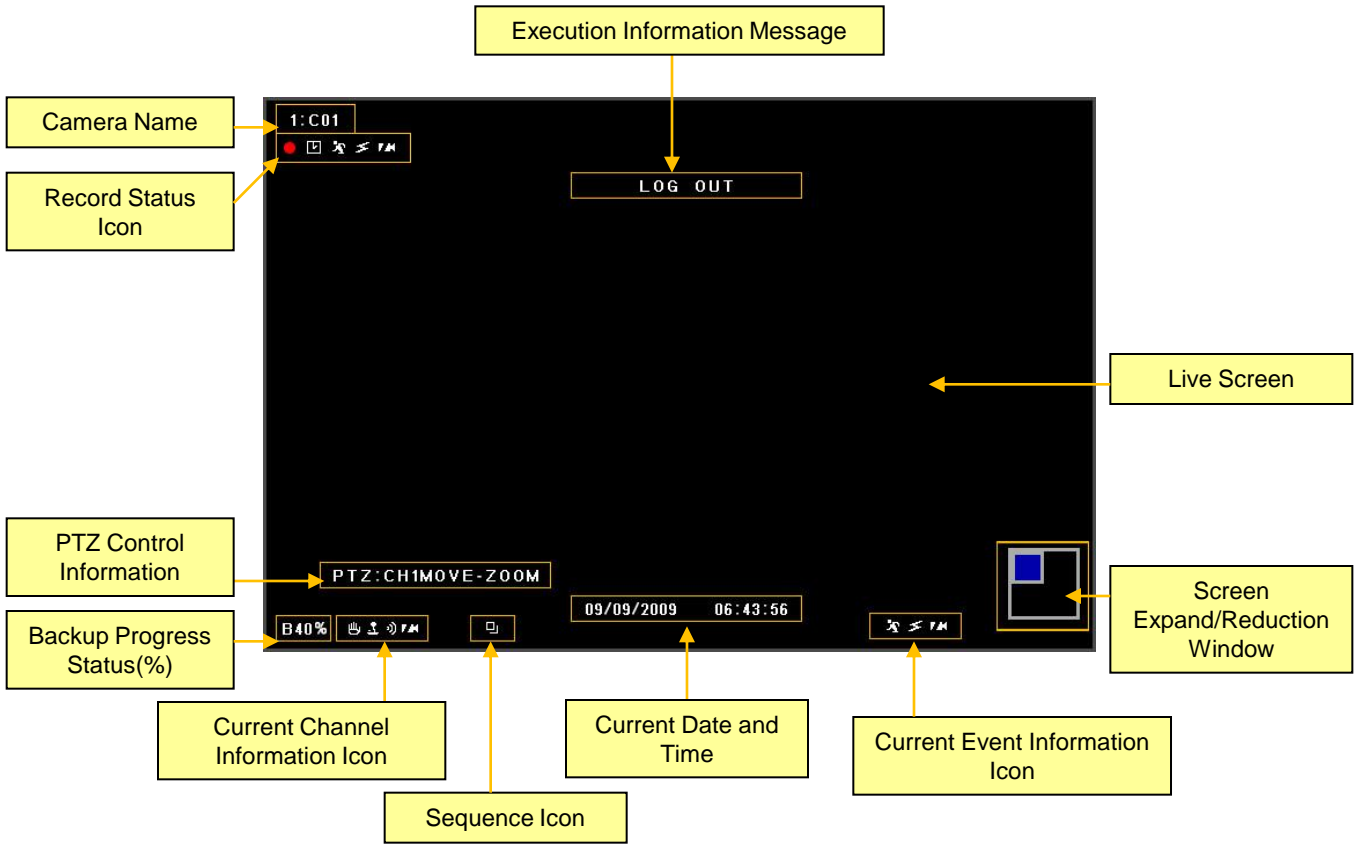

- Record Icon (Red)  
When record in live screen.



- Video-loss Icon  
When there is no video input.



- Time Icon  
When record by designated time.



- Audio Icon  
When sound is generated in live mode.



- Motion Icon  
When motion is occurred.



- Freeze Icon  
When live is paused.



- Sensor Icon  
When sensor is occurred.



- Sequence Icon  
When screen is rotated continuously.

## 4.1.1 Top Menu

In live screen, if ▲ button of the remote controller or front panel is pressed, or if the mouse cursor is placed over the end of the top area, the top menu is appeared.

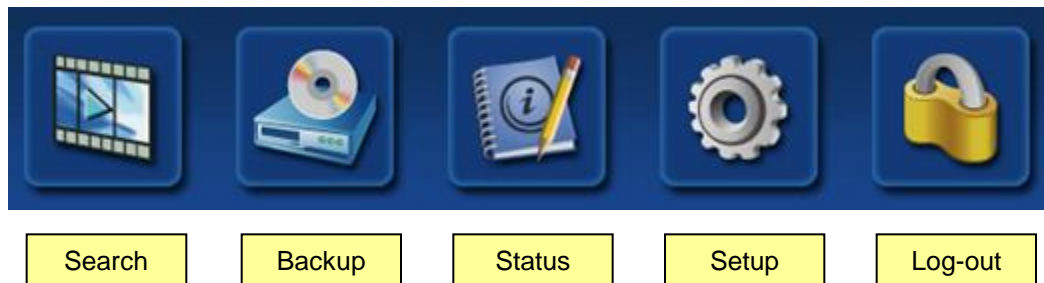

## 4.1.2 Bottom Menu

In Live screen, if ▼ button of the remote controller or front panel is pressed, or if the mouse cursor is placed over the end of the bottom area, the bottom menu is appeared.



## 4.1.3 CAMEO Menu

In live screen, if the ENTER button of the remote controller or front panel is pressed, a blue square cursor will be appeared. If the ENTER button is pressed again, the CAMERA menu will be appeared.



- **ADJUSTMENT** : Adjust the selected camera color setting.
- **CAMEO CHANGE** : The live camera can be changed to the selected channel.  
If the camera number is selected at the pop-up menu shown below, the camera is changed to the selected channel.

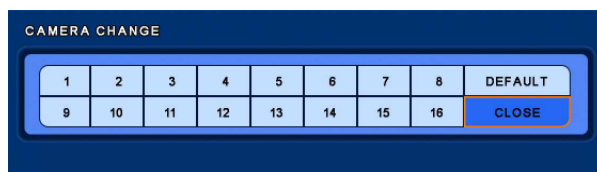

- **PLAYBACK** : Playback with previous recording image (about 20 seconds )
- **FREEZE** : Live screen of the selected channel can be paused.
- **FREEZE ALL** : Live screen of the all channels can be paused.
- **SEQUENCE** : Live screen is rotated.

- **PTZ** : PTZ Camera should be installed otherwise the PTZ menu is not activated.

The following picture will be appeared when select PTZ menu.



- ※ **Using Mouse** : On the above menu, when click the right button of mouse, the control screen for Menu, Zoom, Focus and Iris will be appeared.

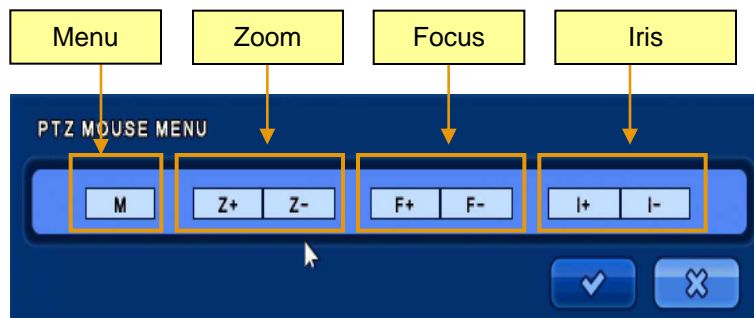

- ※ **Using Remote Controller or Front Key** : The below Hot Key is available.

- Press the ENTER button on PTZ Camera channel.
- Press the ENTER button again then the CAMEO menu will be appeared.
- Select PTZ menu on the Live CAMEO menu.
- Press the ENTER button again, the above PTZ menu screen will be appeared.
- **Zoom Control** : In PTZ mode, press the Zoom (Back) button.  
Zoom in - Fast reverse play button / Zoom out - The fast forward play button.
- **Focus Control** : In PTZ mode, press the Focus (Search) button.  
(+) - Fast reverse play button / (-) – Fast forward play button.
- **Iris Control** : In PTZ mode, press the Iris (Pause) button.  
(+) – Fast reverse play button / (-) – Fast forward play button.



- **SPEED SETUP** : Set the PTZ camera speed. ( 1 to 8)

**NOTE: If the mouse is used to move the PTZ camera, the movement speed depends on the position of the mouse. As the mouse pointer moves away from the center, speed becomes faster.**

- **PRESET SETUP** :

Set the preset position. If the position setup is saved, PTZ camera will be directed to the set position by preset number.

- **PRESET TOUR** :

6 different preset list can be created. If the created preset lists are set to "ON", recording is made with preset tour.

- **PATTERN SETUP** :

Pattern can be created by movement, zoom, focus and iris. After pressing the BEGIN button, adjust the PTZ camera position or zoom and then press the END button. All directions (up, down, left and right), zoom and iris settings are recorded.

- **PATTERN TOUR** : PTZ camera moves according to the saved pattern.

- **AUTO FOCUS / POWER / LIGHT** :

Auto focus, power and light functions can be turned on/off on each category.

- **OSD MENU** : Turn on/off the OSD menu.

▪ **ZOOM X2** : Zoom in x2.

▪ **ZOOM X4** : Zoom in x4.

▪ **AUDIO ON** : Turn on/off Audio.

## 5. SETUP

*In this category, there are General, Camera, Event, Schedule, Ethernet and System Information.*

On the Top menu, select the [SETUP] menu.

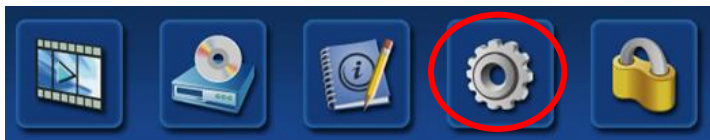

After select the menu, the following Log-in window will be appeared.

LOGIN

ID		root			
PASSWORD		****			
0	1	2	3	4	←
5	6	7	8	9	

✓ ✕

Enter the password by the key buttons and press the ENTER button.

(The default password : 1111)

### 5.1 GENERAL SETUP

*In this category, there are General, Alarm, Disk, Monitor, Account, Configuration setup and Shutdown.*

Select the [GENERAL] menu.



## 5.1.1 GENERAL

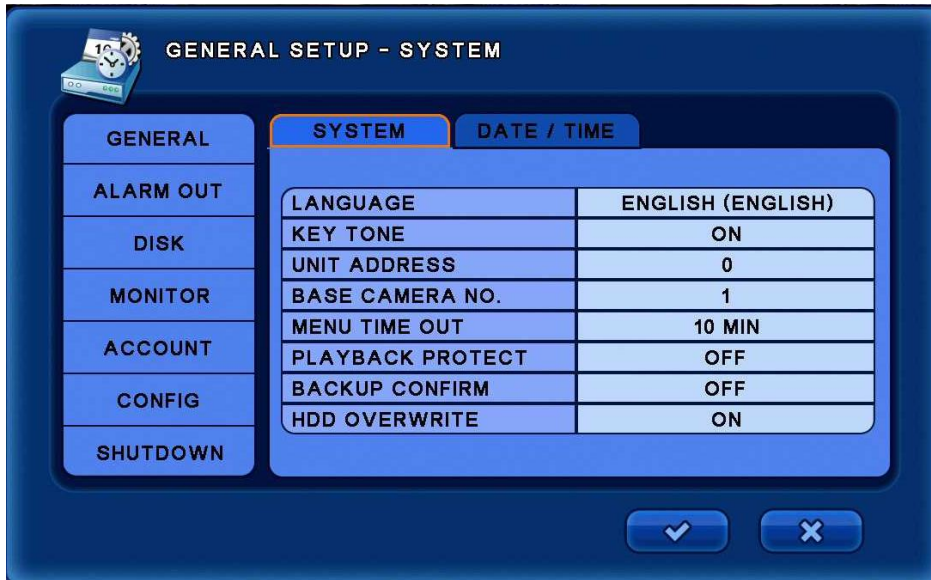

### [SYSTEM]

- **LANGUAGE** : Select the language.  
(English, Germany, French, Spanish, Japanese, Chinese, Italian, Russian, Dutch and Korean)
- **KEY TONE** : Turn on/off the buzzer sound of key.
- **UNIT ADDRESS** : Set the DVR ID.  
This ID can be used when use multi DVR in same place by one remote controller.
- **BASE CAMERA NO.** : Set the beginning number of camera.  
If set this value to 17, the camera number start with 17.
- **MENU TIMEOUT** : Keep the Menu screen for this value then escape from Menu.
- **PLAYBACK PROTECT** : Prohibit the playback of passed data.  
(Select 0 to 99 days. If set 3 days, can not playback the data that elapsed 3 days.)
- **BACKUP CONFIRM** : Confirm the backup process.( Log-in process)
- **HDD OVERWRITE** : Select on/off to overwrite data on Hard disk.

**NOTE: If set to [OFF], recording will be stopped automatically when disk is full.**

## 5.1.1 GENERAL

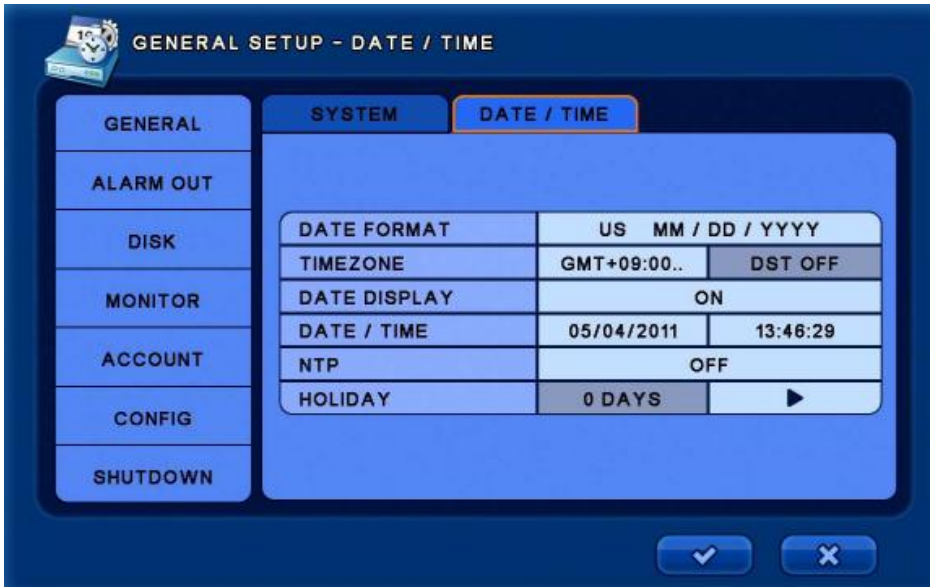

### [DATE / TIME]

- **DATE FROMAT** : Select the data format.  
(YY/MM/DD) / (MM/DD/YY) / (DD/MM/YY)
- **TIMEZONE** : Select the timezone and DST.  
The city which don't use DST is set to [OFF] automatically.
- **DATE DISPLAY** : Display date on live screen or not.
- **DATE / TIME** : Change date and time.
- **NTP** : Select the usage of NTP setting.  
DVR time is synchronized with NTP server and get the standard time.  
The default server is [pool.ntp.org] and User can input other server.  
  
[Sync now] : Synchronize immediately.  
[Auto Sync] : Synchronize every day automatically.
- **HOLIDAY** : Add or delete holiday.



## 5.1.2 ALARM OUT

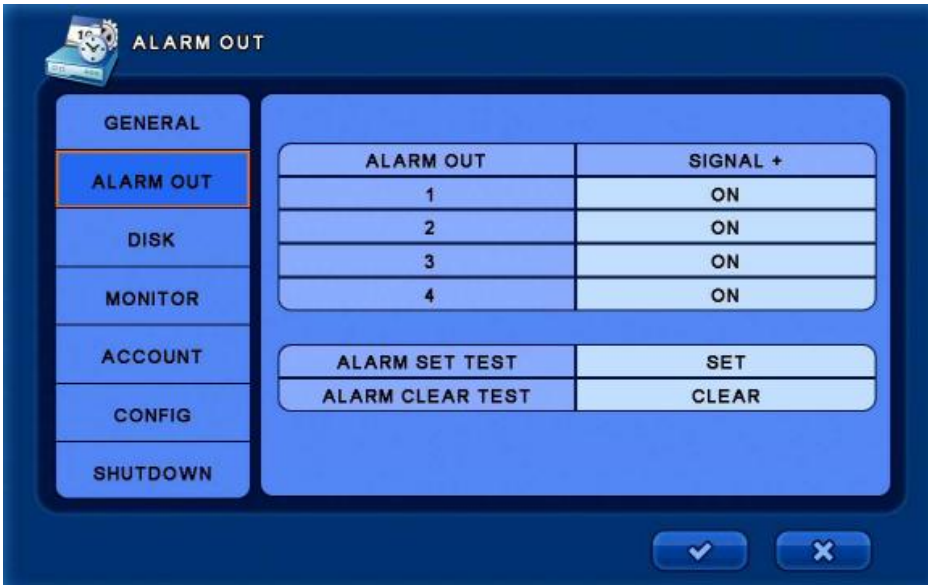

- **SIGNAL** : Select on/off to use alarm by channel.
- **ALARM SET TEST** : Check the alarm connection whether it works properly or not. Press the [SET] button then alarm device will be operated.
- **ALARM CLEAR TEST** : Press the [CLEAR] button then alarm device will not be operated.

## 5.1.3 DISK

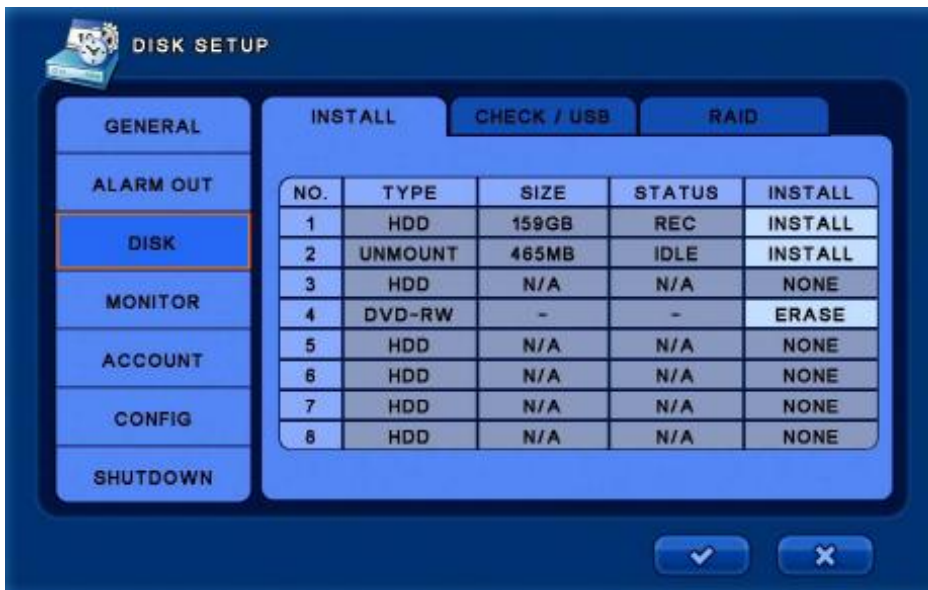

※ **NOTE :**  
**When install HDD first time, after install HDD, should format by the [INSTALL] button.**

**[INSTALL]** - Display initial HDD install and information.

## 5.1.3 DISK



### [CHECK / USB]

- **EARLIEST RECORD** : Display the earliest recorded data information.
- **LATEST RECORD** : Display the latest recorded data information.
- **DISK CHECK** : Check the data from the earliest recorded to the latest recorded.
- **MOUSE RESET** : Reset the mouse connection.
- **USB RESET** : Reset the USB connection.
- **USB FORMAT** : Format the connected USB.



**[RAID] ※ This function will be added.**

- **RAID SETUP** : Select the RAID level (RAID0, RAID1 and RAID5).
- **RAID** : Display RAID on/off status.
- **DISK STATUS** : Display disk status.
- **RAID STATUS** : Display RAID status.
- **RATE** : Display process rate.

**!WARNING!**

- ※ By the RAID LEVEL, minimum 2 or 3 hard disk should be installed.
- ※ Hard disk should be used same model for RAID.
- ※ If hard disk brand or model is different, Disk error can be happened.



When setup the RAID, above message will be appeared.

After select the "V" mark, DVR will be rebooted.

※ Rebooting for RAID, booting time is longer than normal. (About 5 minutes)

**!WARNING**

※ When RAID is built, all data of HDD will be deleted.

※ If data is saved on HDD, backup the data.

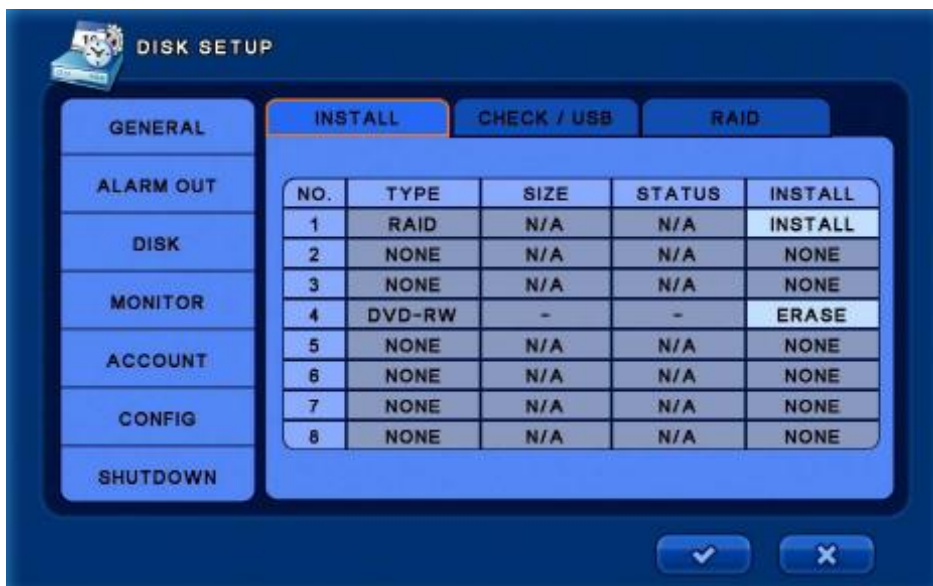

After build RAID, the type will be changed to [RAID] and recognize to 1 HDD.

Supported RAID level is 0, 1, 5.

## ※ RAID 0

- For building RAID Level 0, it will take about 5 minutes.
- Displayed with [GOOD], if the building is finished without any problem



## ※ RAID 1

- For building RAID Level 1, building time depends on the HDD capacity.  
(In case of 1TB HDD, it will take 24~48 hours)
- Check the status on [RAID STATUS] and [RATE].



## ※ RAID 5

- For building RAID Level 1, building time depends on the HDD capacity.  
(In case of 1TB HDD, it will take 24~48 hours)
- Check the status on [RAID STATUS] and [RATE].

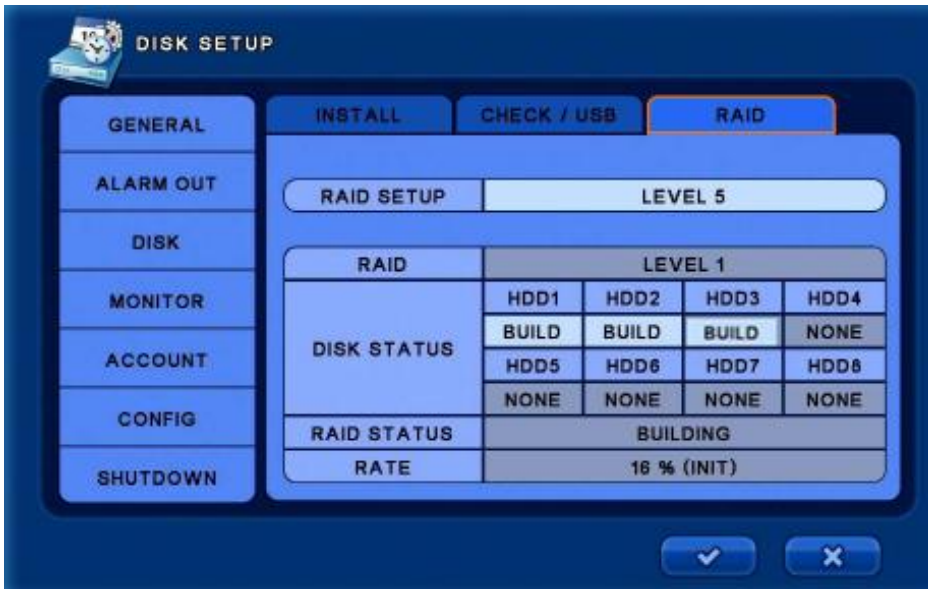

## 5.1.4 MONITOR

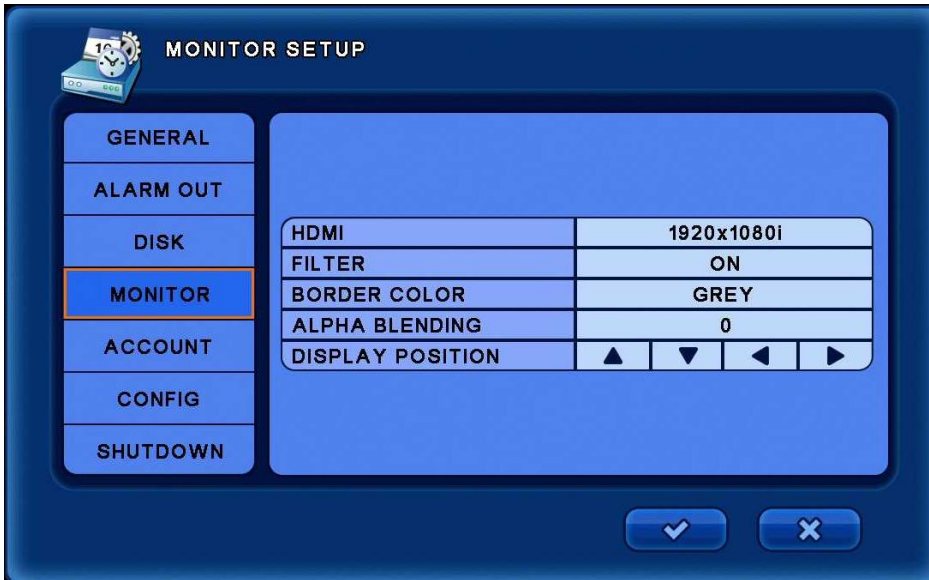

- **HDMI** : Select the HDMI resolution for connected monitor.
- **FILTER** : Select On/Off for image filtering.
- **BORDER COLOR** : Change the border color.
- **ALPHA BLENDING** : Set the transparency of menu.  
(Set 1 to 20 and 20 is closer to the more transparent.)
- **DISPLAY POSITION** : Adjust the display position.



[RESOLUTION selected screen]



[ALPHA BLENDING selected screen]

## 5.1.5 ACCOUNT

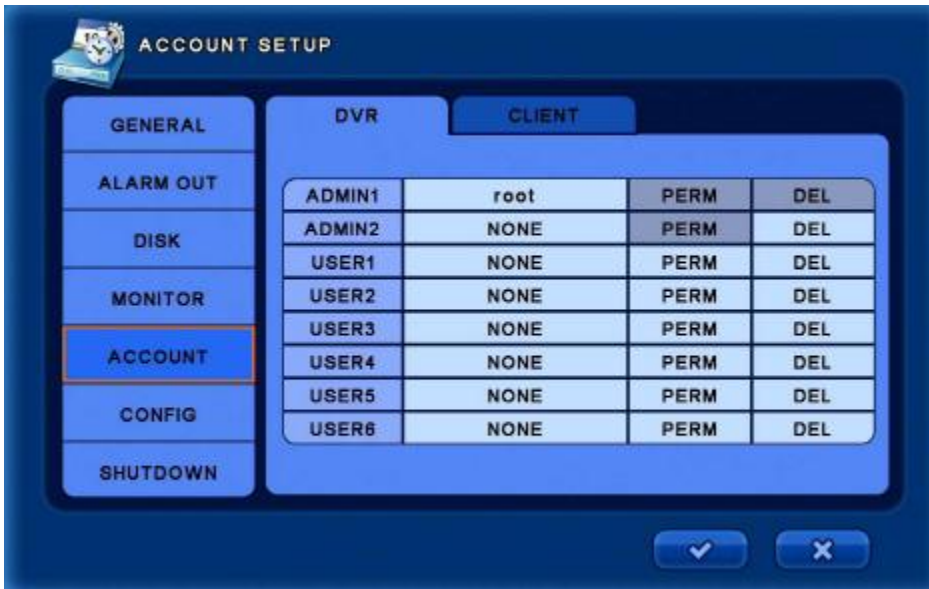

- ※ Add / delete any user and give permission freely.
- ※ When add new user, have to input new password.  
When delete use, confirm again.

**NOTE: ( Default ADMIN password is 1111 ), Initial user name can be modified but can not delete.**

### CAUTION:

Default Admin account must not be deleted before add new user.

If delete default Admin user before add new Admin user, can not access on [SETUP] menu.

- ※ By the [PERM] menu, can give permission to each ID.



## 5.1.6 CONFIG

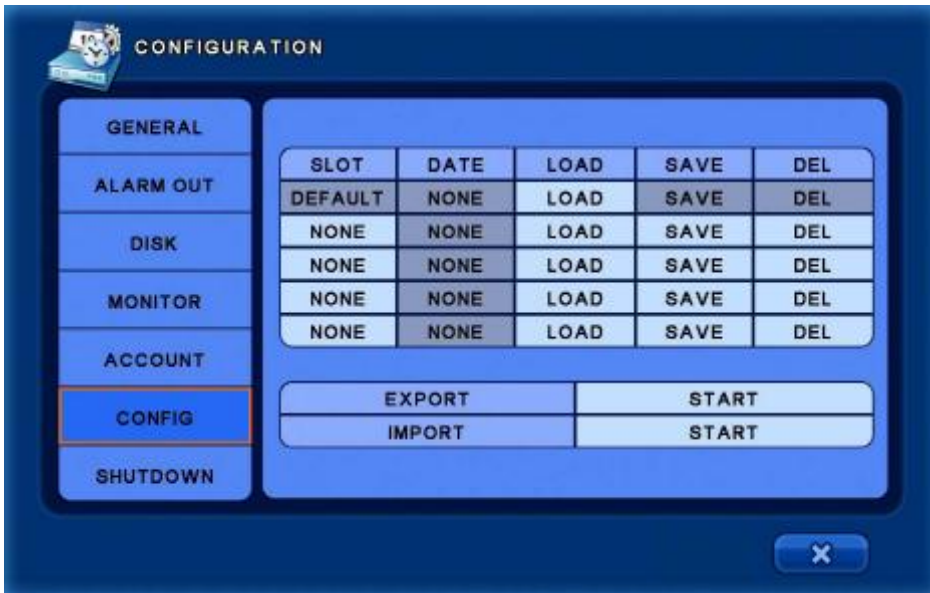

- **SLOT** : Select the slot to load or save on DVR memory.
  - ※ DEFAULT : Change factory default setting.
- **DATE** : Display the latest saved date.
- **LOAD** : Load the saved data.
- **SAVE** : Save the set data.
- **DEL** : Delete the saved data on Slot.
- **EXPORT** : Export the set data to USB or DVD.
- **IMPORT** : Import the set data to USB or DVD.



[DEFAULT selected screen]

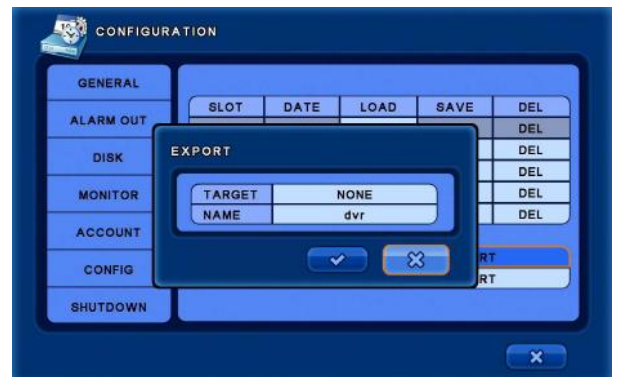

[EXPORT selected screen]

## 5.1.7 SHUTDOWN



- **RESTART** : Restart the DVR.
- **SHUTDOWN** : Shutdown the DVR.

## 5.2 CAMERA SETUP

In this category, there are Camera, PTZ, Spot, Sequence and Private Zone setting.

Select the [CAMERA] Menu.



### 5.2.1 CAMERA

CAM	NAME	INSTALL +	HIDDEN +
1	C01	ON	OFF
2	C02	ON	OFF
3	C03	ON	OFF
4	C04	ON	OFF
5	C05	ON	OFF
6	C06	ON	OFF

- **CAMERA LABEL** : Select the camera label of live screen.  
(ALL / NUMBER / NAME / OFF)
- **RESOLUTION** : Select the camera resolution. (1080 / 720 / AUTO)
- **NAME** : Change the camera name. ( If select the camera name, the virtual keyboard will be appeared.)
- **INSTALL** : Select On/Off button to use camera.
- **HIDDEN** : Select On/Off button to hide camera on live view. ( Record operate correctly.)

**NOTE: If select [INSTALL] – [OFF], Camera name and number are not displayed.**

## 5.2.1 CAMERA



If select the camera name, the virtual keyboard will be appeared. Max camera name should be less than 11 character.

[Virtual Keyboard]

## 5.2.2 PTZ



### [PTZ]

- **PORT** : Select the Baud Rate for using PTZ camera.
- **ID** : Select the ID for using PTZ camera.
- **TYPE** : Show the PTZ protocol list.

***NOTE*** : baud rate, data bit, parity, stop bit, ID and protocol depend on PTZ camera for using.

***CAUTION*** : When connect the camera on the RS-485 port, refer to the manual of camera manufacture.

## 5.2.3 SPOT

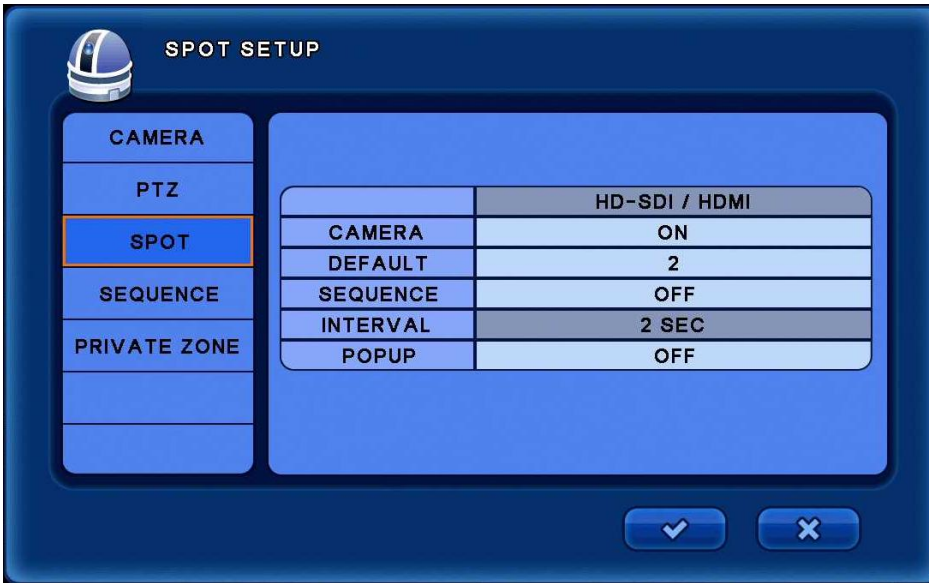

**CAMERA** : Select the camera for display on spot monitor.

**DEFAULT** : Select the camera for display on spot monitor when sequence is off.

**SEQUENCE** : Select On/Off for sequence screen.

**INTERVAL** : Select the interval time to move next channel. The max value is 256 sec.

**POPUP** : Select On/Off for pop-up screen when event is occurred.

***NOTE: Same channel image can not be displayed on each spot monitor.***



[CAMERA selection screen]



[INTERVAL selection screen]

## 5.2.4 SEQUENCE

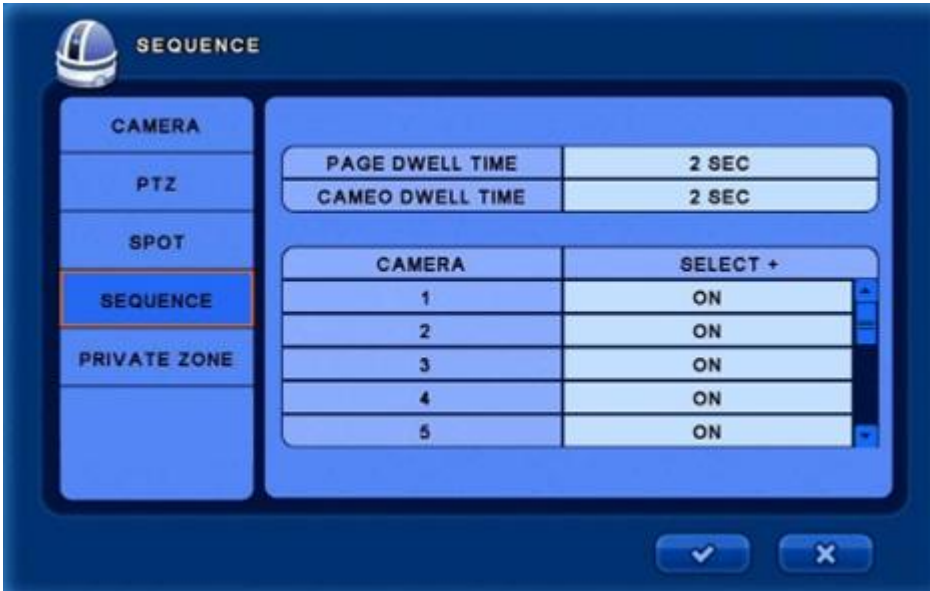

**PAGE DWELL TIME** : Select the dwell time to move next channel.

**CAMEO DWELL TIME** : Select the dwell time for CAMEO sequence.

**NOTE: CAMEO sequence means selected camera is rotated in select cameo of division screen.**  
**Camera image which is shown on the other CAMEO of division screen is not included in CAMEO sequence.**



[DWELL-TIME selected screen]

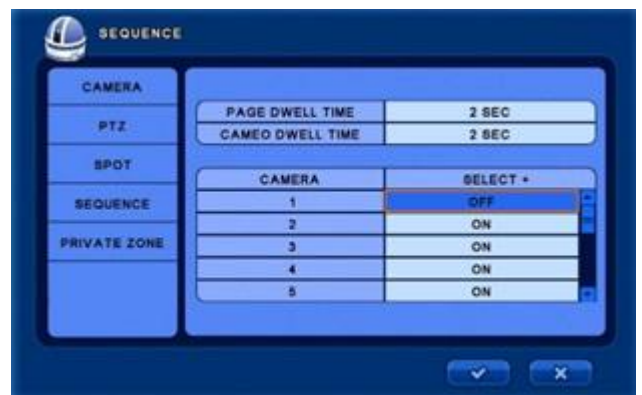

[CAMERA SELECT 선택화면]

## 5.2.5 PRIVATE ZONE



- **ZONE ENABLE** : Select On/Off to use. (LIVE mode/ SEARCH mode)
- **ZONE COLOR** : Select the color to hide.
- **ZONE** : Select the zone to hide.

(When select the ZONE button, the camera image will be appeared.)

**NOTE** : **Move the blue dot to a desired location and press the OK button.**  
**Drag and move it to include the desired area and press the OK button.**  
**As a result, the area is covered and hidden with the selected color**

**TIP** : **On the screen, if click the right button of mouse, a menu will be appeared.**  
**Using this menu, a selected area can be delete or saved, or returned previous menu.**

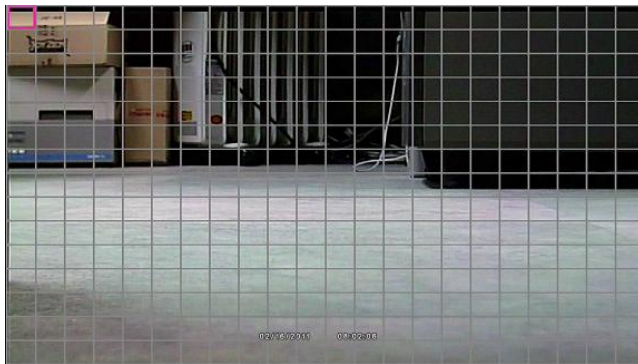

[ZONE selected screen]



[Mouse right button selected screen]

## 5.3 EVENT SETUP

In this menu, there are Motion, Alarm in, Video Loss, System and Display setup.

Select the [EVENT] menu.



### 5.3.1 MOTION

CAMERA	ACTIVE +	LEVEL +	AREA +
1	ON	3	ON
2	ON	3	ON
3	ON	3	ON
4	ON	3	ON
5	ON	3	ON
6	ON	3	ON
7	ON	3	ON

#### [INPUT]

- **ACTIVE** : Select On/Off to activate motion.
- **LEVEL** : Select the sensitive for motion trigger. (Select 1 to 5 level)
- **AREA** : Select the motion area.

**TIP: If select the ACTIVE+ / LEVEL+ / AREA+ menu, can change all setting at once.**



## ▪ AREA SETUP

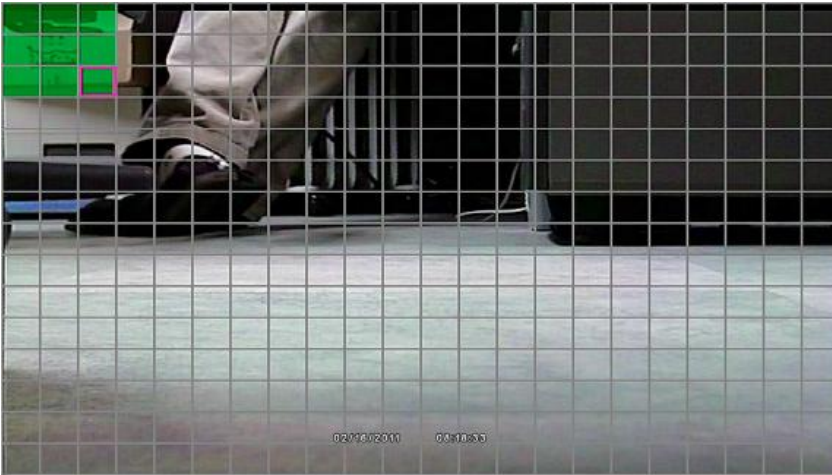

In the Area setup, the Red square is shown at the top left side of the screen. If select the OK button, the dot color will be changed to Green. A motion area can be selected by the direction buttons.

**NOTE : When the status is Red square, can move any direction to select.**  
**When the status is Green color, can select motion area or cancel the set area.**

After set the motion area, if select the MENU button, the following screen will be appeared.

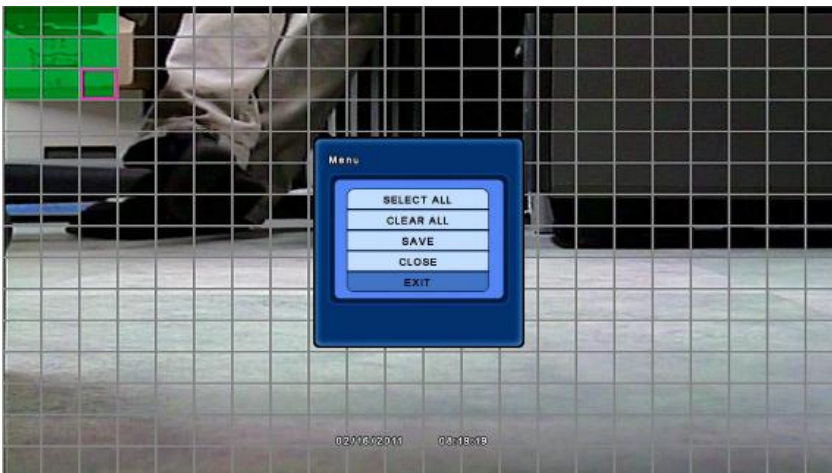

- **SELECT ALL** : Select all motion area.
- **CLEAR ALL** : Clear all motion area.
- **SAVE** : Save the changed setting.
- **CLOSE** : Close the pop-up screen.
- **EXIT** : Exit the motion area setup.



**[ACTION]**

- **RECORD** : Select the channel for record.
- **ALARM** : Select On/Off for alarm.
- **BUZZER** : Select On/Off for buzzer.
- **PRESET** : Set the preset number.  
(When motion is triggered, the PTZ camera move to the set preset number position)
- **E-MAIL** : Select On/Off for e-mail notification.

**TIP: If select to the [DEFAULT], only record the channel which is occurred event.**



## 5.3.2 ALARM IN



**TIP:**

**If select the ACTIVE+ / TYPE+ menu, can change all setting at once.**

### [INPUT]

- **ACTIVE** : Select On/Off to activate alarm.
- **NAME** : Type any name.
- **TYPE** : Select the alarm type. (NO : Normal Open / NC : Normal Close)

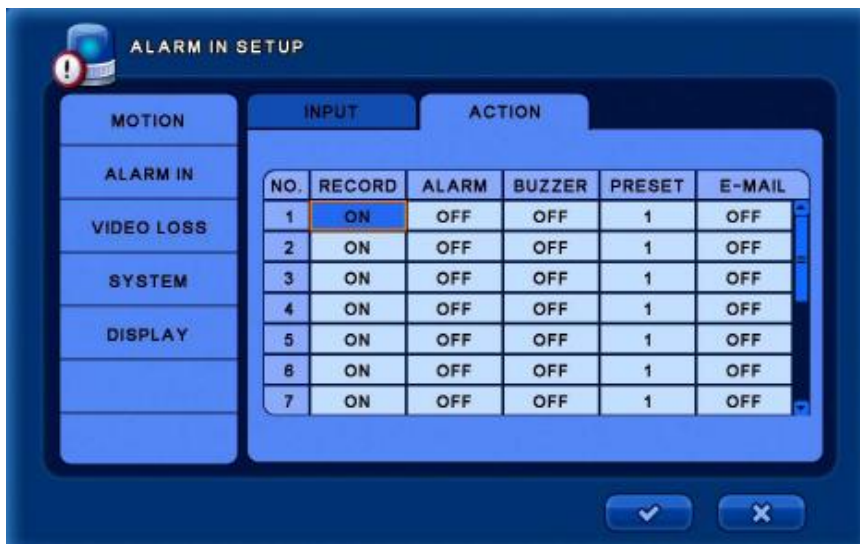

### [ACTION]

- **RECORD** : Select the channel for record.
- **ALARM** : Select On/Off for alarm.
- **BUZZER** : Select On/Off for buzzer.
- **PRESET** : Set the preset number.  
(When motion is triggered, the PTZ camera move to the set preset number position)
- **E-MAIL** : Select On/Off for e-mail notification.

### 5.3.3 VIDEO LOSS



**TIP:**  
If select the ACTIVE+ menu,  
can change all setting at once.

#### [INPUT]

- **ACTIVE** : Select On/Off to activate.



#### [ACTION]

- **RECORD** : Select On/Off for record.
- **ALARM** : Select On/Off for alarm.
- **BUZZER** : Select On/Off for buzzer.
- **PRESET** : Set the preset number.  
(When motion is triggered, the PTZ camera move to the set preset number position)
- **E-MAIL** : Select On/Off for e-mail notification.

### 5.3.4 SYSTEM

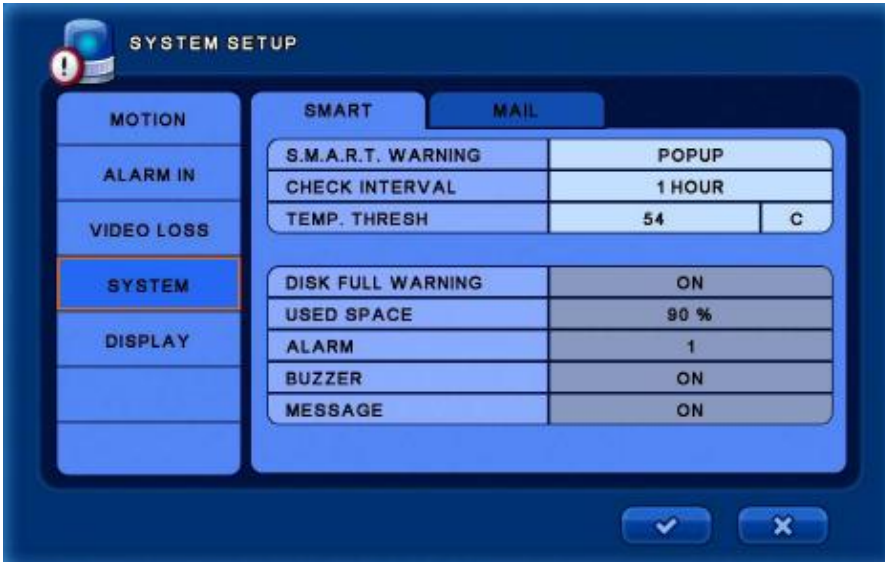

#### [SMART]

- **SMART WARNING** : Select the option for smart warning. (POPUP + BUZZER / POPUP / OFF)
- **CHECK INTERVAL** : Select the check interval time. (Select 1 hour to 24 hour)
- **TEMP. THRESH** : Select the warning temperature. (C: 0 to 100 / F : 32 to 212)
- **DISK FULL WARNING** : Select On/Off to disk full warning.
- **USED SPACE** : Display the used space.
- **ALARM** : Select the channel for alarm out.
- **BUZZER** : Select On/Off for buzzer.
- **MESSAGE** : Select On/Off for message.



[MAIL] – Select option On/Off for e-mail notification.

- **POWER / MENU / LOGIN FAIL / DISK FULL / LOG IN / SMART**

## 5.3.5 DISPLAY



- **DISPLAY** : Select display time by second. (Select 0 to 100)
- **EVENT MESSAGE** : Select On/Off to display event message.
- **EVENT POPUP** : Select On/Off to pop-up.

## 5.4 RECORD SETUP

In this menu, there are Resolution, Schedule, Record, Audio, Manual, Filter setup.

Select the [RECORD] menu.

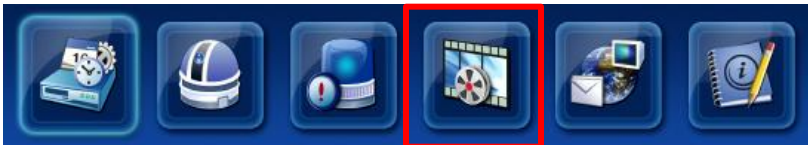

### 5.4.1 SCHEDULE



- **SETUP MODE** : Select the record schedule. (TYPICAL / CUSTOM)

#### [TYPICAL]

- **DAY TIME** : Select the day time. (The night time is changed automatically according to the day time zone)
- **WEEKEND** : Set the weekend zone.

## [CUSTOM]

- Set 3 different recording setup by day and time. (REC0, REC1, REC2)

This is related with [RECORD] menu so [CUSTOM] mode should be matched with [RECORD] menu.

**TIP : For REC0, REC1, REC2 recording, change the setting [SETUP MODE] to [TYPICAL] and enter to the [RECORD] menu then change the setting.**

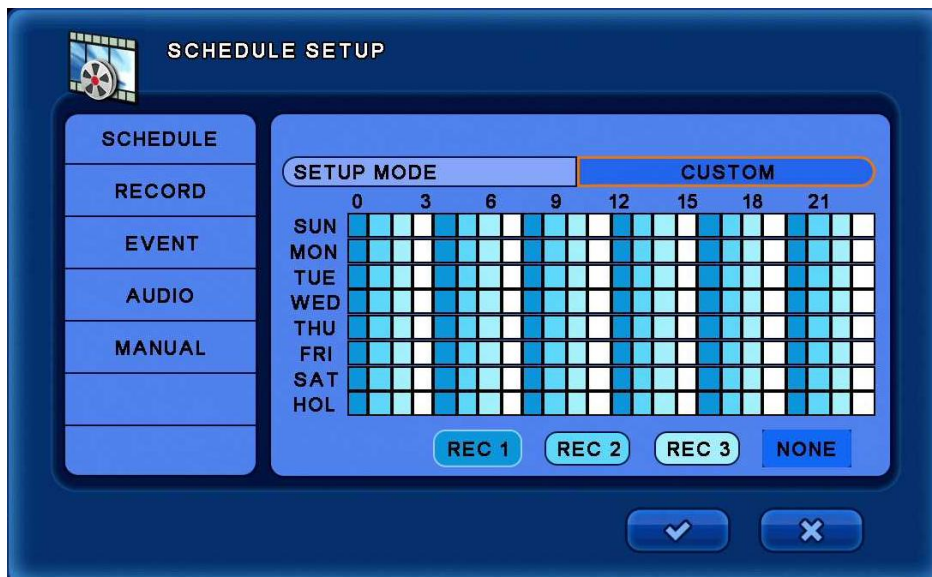

[CUSTOM selected screen]



## 5.4.2 RECORD



[DAY] / [NIGHT] / [WEEKEND]

- **TIME** : Set the recording frame and resolution by channel.
- **EVENT** : Set the event recording. (Frame / Resolution / Post recording time [5 to 100 second])

**TIP** : The frame can be set by the direction button in setup screen.

If set to [CUSTOM] in [SCHEDULE] menu, the DAY / NIGHT / WEEKEND menu will be changed to REC0/ REC1 / REC2. Also set the frame and resolution.



[RECORD] screen after select [CUSTOM] menu

## 5.4.3 EVENT



- **EVENT** : Select the Pre recording time and Post recording time.

***TIP:** If select the RECORD+ menu, can change all setting at once.*

## 5.4.4 AUDIO



- **AUDIO** : Select On/Off for audio recording by each channel.

## 5.4.5 MANUAL

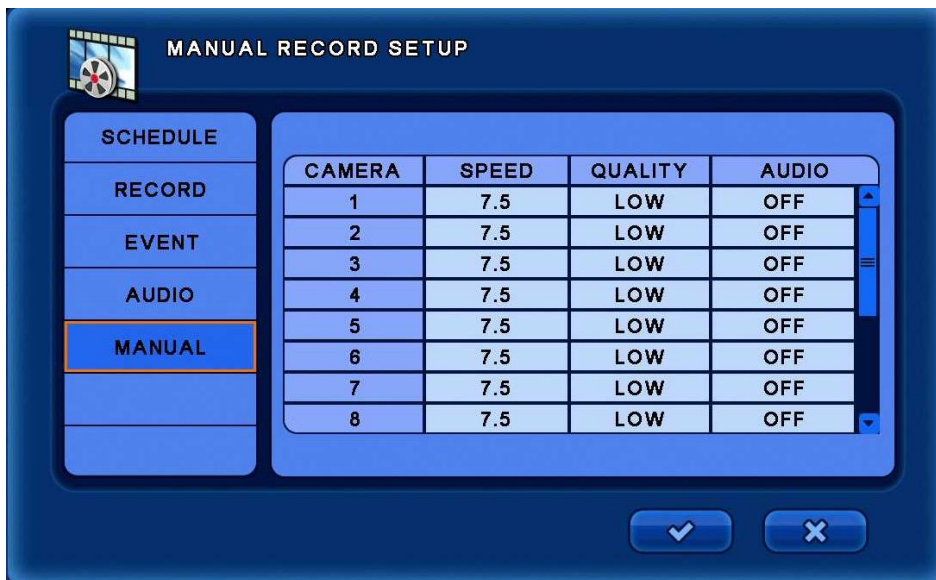

Manual Recording is same as Panic recording.

This function can be worked by the [REC] button on Remote controller or Front panel.

- **SPEED** : Select the recording frame by each channel.
- **Quality** : Select the resolution by each channel.
- **AUDIO** : Select On/Off for audio recording by each channel.

## 5.5 ETHERNET SETUP

In this menu, there are Network, Serial, DDNS, E-mail setup.

Select the [ETHERNET] menu.



### 5.5.1 NETWORK

ETHERNET	ETHERNET2	CLIENT
DYNAMIC IP		OFF
HOST NAME		dvr
IP ADDRESS		192.168.2.252
SUBNET MASK		255.255.255.0
GATEWAY		192.168.2.1
DNS SERVER		192.168.2.1
CHECK INTERNET		START

#### [ETHERNET]

- **DYNAMIC IP** : Select On/Off for dynamic IP.

*If Dynamic IP is OFF, DVR get IP address from router automatically.*

- **HOST NAME** : Type any Host name.
- **IP ADDRESS** : Type IP address. (Available when DYNAMIC IP is OFF)
- **SUBNET MASK** : Type Subnet mask. (Available when DYNAMIC IP is OFF)
- **GATEWAY** : Type Gateway. (Available when DYNAMIC IP is OFF)
- **DNS SERVER** : Type DNS server. (Available when DYNAMIC IP is OFF)
- **CHECK INTERNET** : Check internet status for use.

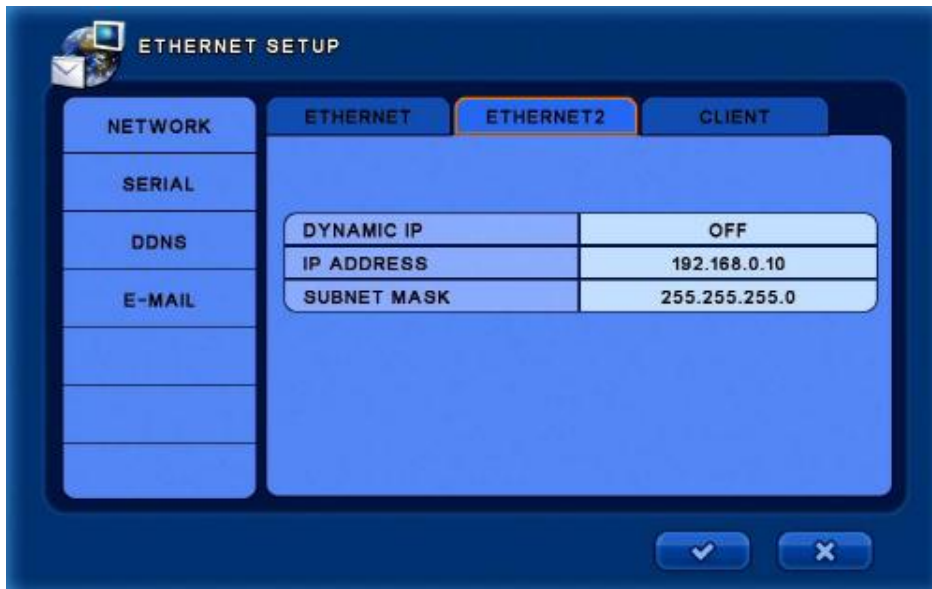

## [ETHERNET2]

- **DYNAMIC IP** : Set to OFF.
- **IP ADDRESS** : Input the IP address that it should be same network class.
- **SUBNET MASK** : Input the subnet mask.

### **※ NOTICE ※**

**IP Address should be inputted same IP class as IP camera.**

**EX)** If IP camera address is 192.168.0.1 ~ 4, IP address of ETHERNET2 should be 192.168.0.xxx

## 5.5.1 NETWORK

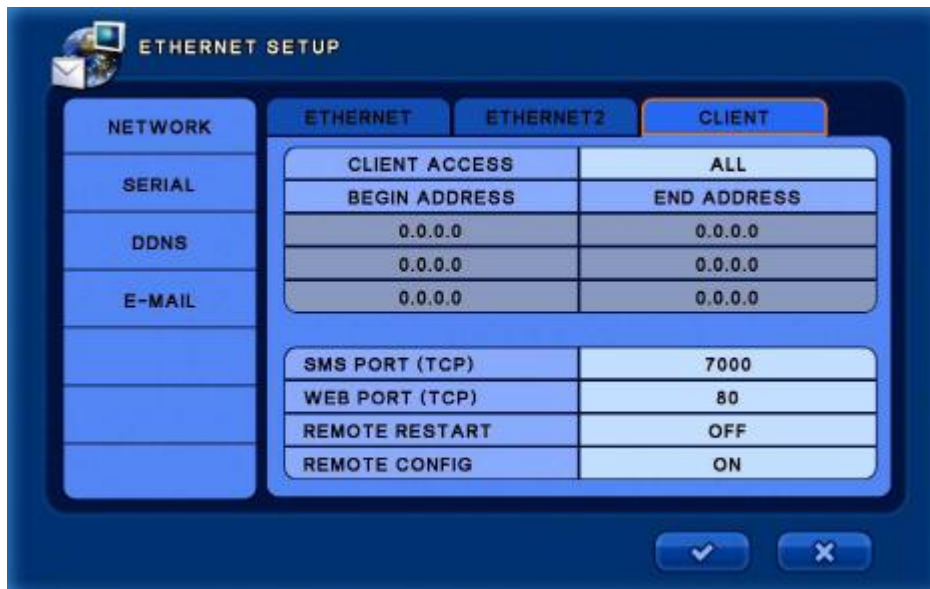

The screenshot shows the 'ETHERNET SETUP' window with the 'CLIENT' tab selected. The interface includes a sidebar with 'NETWORK', 'SERIAL', 'DDNS', and 'E-MAIL' options. The main area is divided into two sections: 'CLIENT ACCESS' and 'SMS PORT (TCP)', 'WEB PORT (TCP)', 'REMOTE RESTART', and 'REMOTE CONFIG'. The 'CLIENT ACCESS' section has a table with columns for 'CLIENT ACCESS' and 'ALL', and rows for 'BEGIN ADDRESS' and 'END ADDRESS', all containing '0.0.0.0'. The other section has a table with columns for the parameter name and its value.

ETHERNET	ETHERNET2	CLIENT
CLIENT ACCESS		ALL
BEGIN ADDRESS		END ADDRESS
0.0.0.0		0.0.0.0
0.0.0.0		0.0.0.0
0.0.0.0		0.0.0.0
SMS PORT (TCP)		7000
WEB PORT (TCP)		80
REMOTE RESTART		OFF
REMOTE CONFIG		ON

### [CLIENT]

- **CLIENT ACCESS** : Select client access options. ( ALL / RANGE )
- **BEGIN ADDRESS / END ADDRESS** (When select RANGE option, type the IP address to accept)  
: Input the acceptable IP address.
- **SMS PORT (TCP)** : Select SMS port.
- **WEB PORT (TCP)** : Select Web port.
- **REMOTE RESTART** : Select On/Off to restart DVR at remote.
- **REMOTE CONFIG** : Select On/Off to change configuration.

## 5.5.2 SERIAL

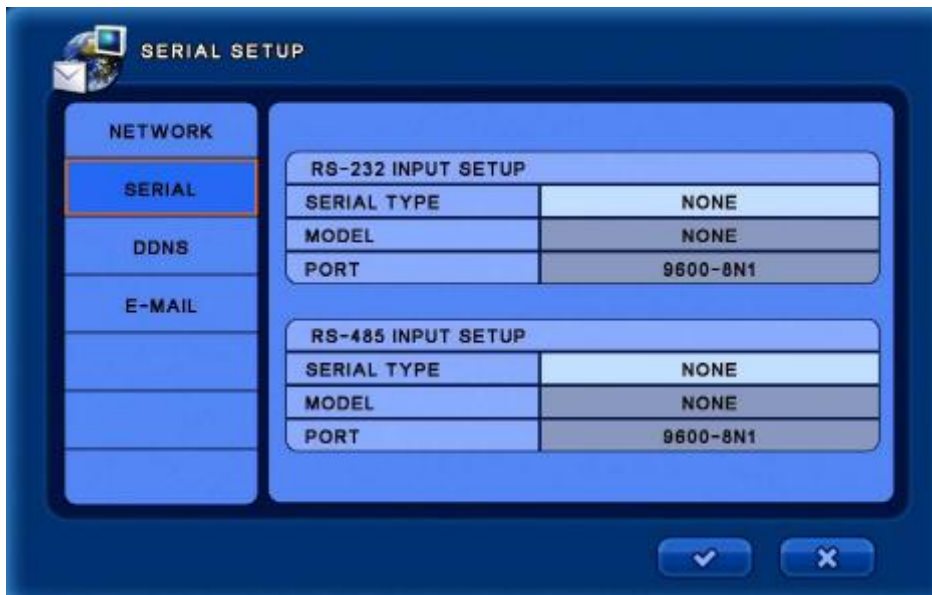

### [RS-232 INPUT SETUP]

- **SERIAL TYPE** : Select external device.
- **MODEL** : Select the protocol to use.
- **PORT** : Select the Baud Rate / DATA bit / Parity / Stop Bit.

### [RS-485 INPUT SETUP]

- **SERIAL TYPE** : Select external device.
- **MODEL** : Select the protocol to use.
- **PORT** : Select the Baud Rate / DATA bit / Parity / Stop Bit.

## 5.5.3 DDNS

DDNS SETUP

NETWORK	DDNS SERVER		NONE
SERIAL	HOST NAME		
DDNS	USER NAME		
E-MAIL	PASSWORD		
	ROUTER IP		OFF
	STATUS	UNCHECKED	CHECK

✓ ✕

- **DDNS SERVER** : Select DDNS server. (Ddnsvr.com / Dyndns.com / ChangeIP.com)
- **HOST NAME** : Input the host name from the registered on DDNS server.
- **USER NAME** : Input the user name from the registered on DDNS server.
- **PASSWORD** : Input the password from the registered on DDNS server.
- **ROUTER IP** : Select On/Off for sending IP information to the DDNS server.  
If use any router, this setting should be [ON].
- **STATUS** : Check the connection status.

**NOTE** : **For using DDNS server, firstly connect the DDNS server and register Host name, User name password then input those information on above menu.**



## 5.5.4 E-MAIL



The screenshot shows the 'E-MAIL SETUP' window with the 'ADDRESS' tab selected. The 'SERVER' tab is also visible. The 'SEND E-MAIL' and 'SCHEDULE' options are both set to 'ON'. The 'FROM' time is '00:00:00' and the 'TO' time is '23:59:59'. A table lists six 'E-MAIL ADDRESS' entries, all set to 'email@ddnsdvr.com'.

NO.	E-MAIL ADDRESS
1	email@ddnsdvr.com
2	email@ddnsdvr.com
3	email@ddnsdvr.com
4	email@ddnsdvr.com
5	email@ddnsdvr.com
6	email@ddnsdvr.com

### [ADDRESS]

- **SEND E-MAIL** : Select On/Off for use.
- **SCHEDULE** : Set the usage time. (From : Start time / To : End time)
- **E-MAIL ADDRESS** : Input the E-mail address to receive.



The screenshot shows the 'E-MAIL SETUP' window with the 'SERVER' tab selected. The 'MAIL SERVER' and 'SMTP SERVER' options are both set to 'DVR System'. The 'USER NAME' is 'UserName', 'USER E-MAIL' is 'email@ddnsdvr.com', 'SERVER ADDRESS' is 'ddnsdvr.com', 'SERVER PORT' is '25', 'LOGIN ID' is 'Userid', and 'LOGIN PASSWORD' is '\*\*\*\*'.

MAIL SERVER	SMTP SERVER
DVR System	DVR System
USER NAME	UserName
USER E-MAIL	email@ddnsdvr.com
SERVER ADDRESS	ddnsdvr.com
SERVER PORT	25
LOGIN ID	Userid
LOGIN PASSWORD	****

### [SERVER]

- **MAIL SERVER** : Select the mail server. (SMTP server / DVR System)
- **USER NAME** : Input the user name.
- **USER E-MAIL** : Input the user e-mail address.
- **SERVER ADDRESS** : Input the server address.
- **SERVER PORT** : Input the server port.
- **LOGIN ID** : Input the Login ID.
- **LOGIN PASSWORD** : Input the Login password.

## 5.6 SYSTEM SETUP

In this menu, there are System Log, Status, Version.

Select the [SYSTEM] menu.



### 5.6.1 SYSTEM LOG

NO.	DATE	SYSTEM LOG
0089	05/04 17:11:28	Video Loss Camera 2
0088	05/04 17:11:21	Video Loss Camera 4
0087	05/04 17:09:57	Video Loss Camera 2
0086	05/04 17:03:54	Video Loss Camera 2
0085	05/04 17:03:38	Schedule Changed
0084	05/04 17:03:32	Record Setup Changed
0083	05/04 17:02:54	Video Loss Camera 2
0082	05/04 17:01:05	Video Loss Camera 2

- Check the system log by the left, right direction button.

## 5.6.2 STATUS



### [DISK]

- Display HDD Status.
- **CHECK SMART NOW** : Check the smart.
- **SMART INFORMATION** : Show the smart information.



### [RECORD]

- Display RECORD Status.

## 5.6.2 STATUS

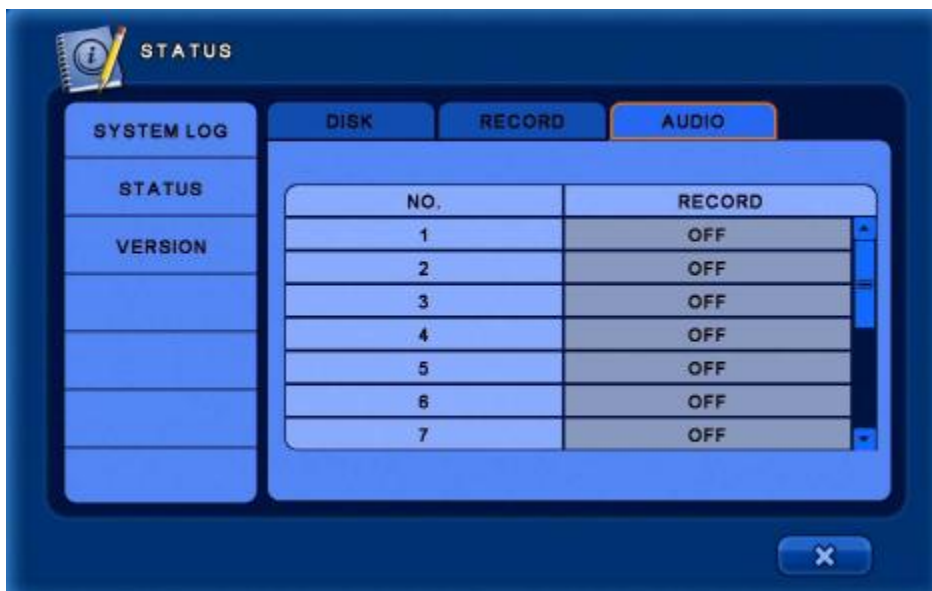

### [AUDIO]

- Display AUDIO Status.

## 5.6.3 VERSION



- Display DVR version and information.

# 6. SEARCH

On the Top menu, select the [SEARCH] menu.

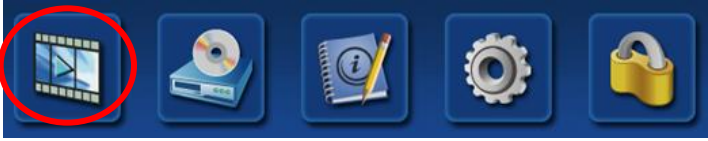

After select the menu, the following Log-in window will be appeared.



Enter the password by the key buttons and press the ENTER button.

(The default password : 1111)



- **QUICK SEARCH** : 사용자가 지정한 시간을 검색
- **CALENDAR** : Search by date and time with Calendar.
- **EVENT SEARCH** : Search by event
- **OVERLAPPED LIST** : Search the overlapped data by changing time
- **GO TO FIRST** : Search with initial saved data.
- **GO TO LAST** : Search with the latest saved data.

# 6.1 Search Screen Configuration

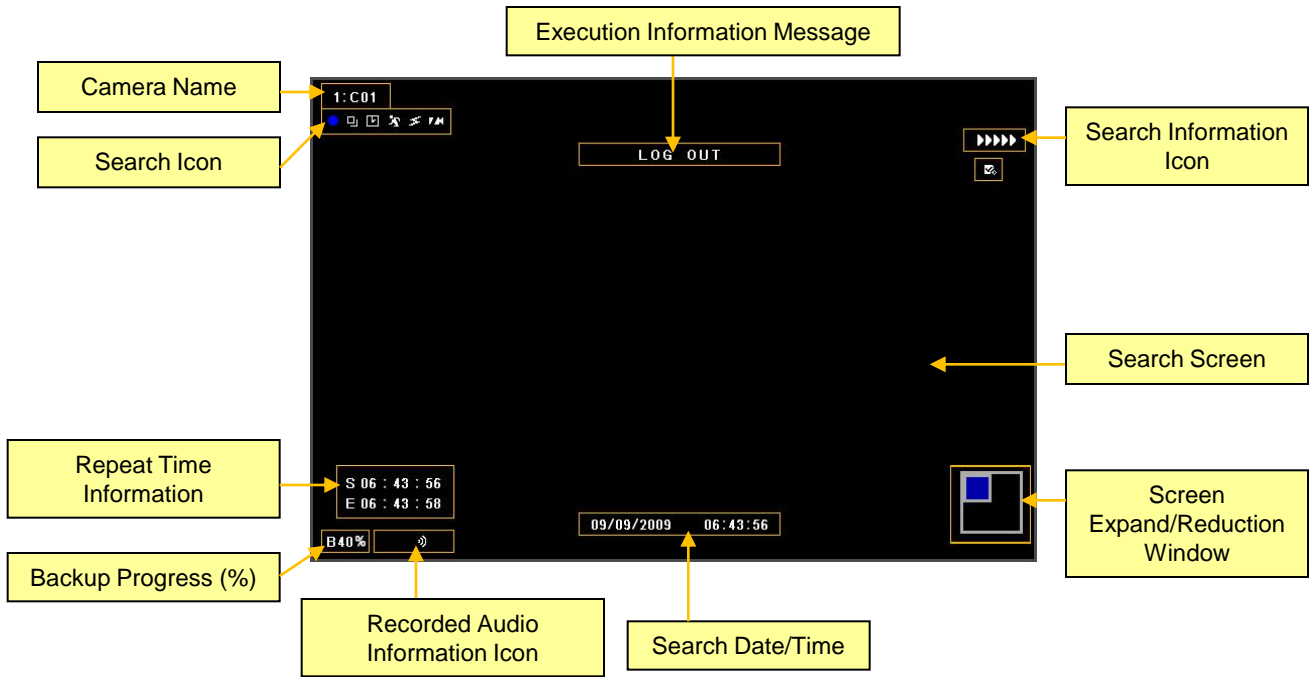

## 6.1.1 Search Menu

When mouse cursor is placed over on the bottom side, the Search menu is appeared.

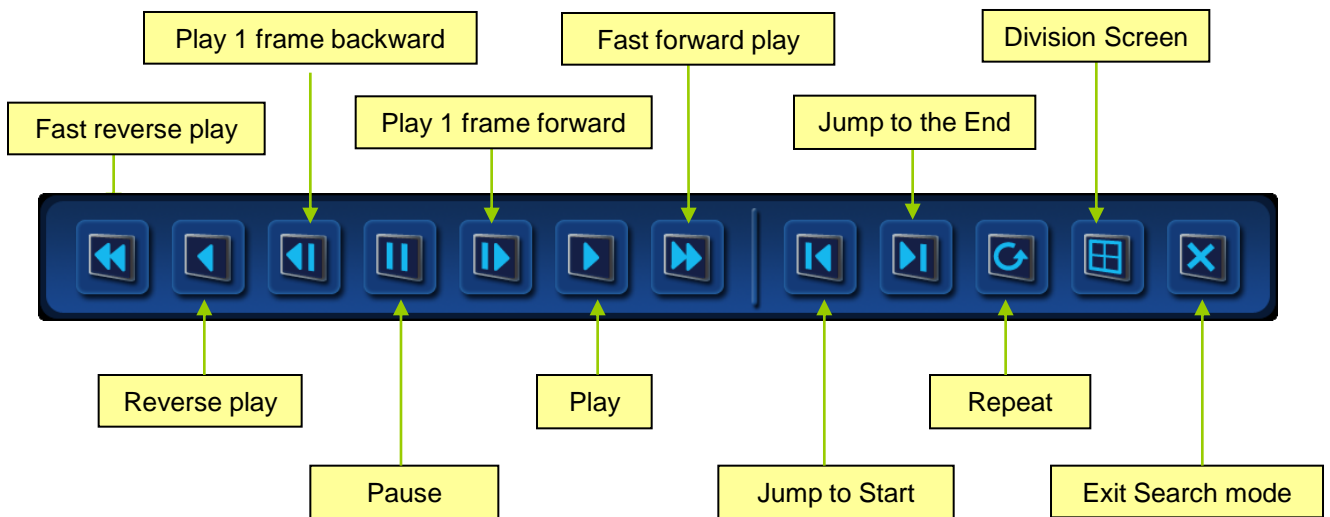

※ As in the live screen, the top menu can be used in the search screen.

## 6.1.2 CALENDAR SEARCH



- Select the data by the direction button.
  - Recorded data is displayed the orange color.

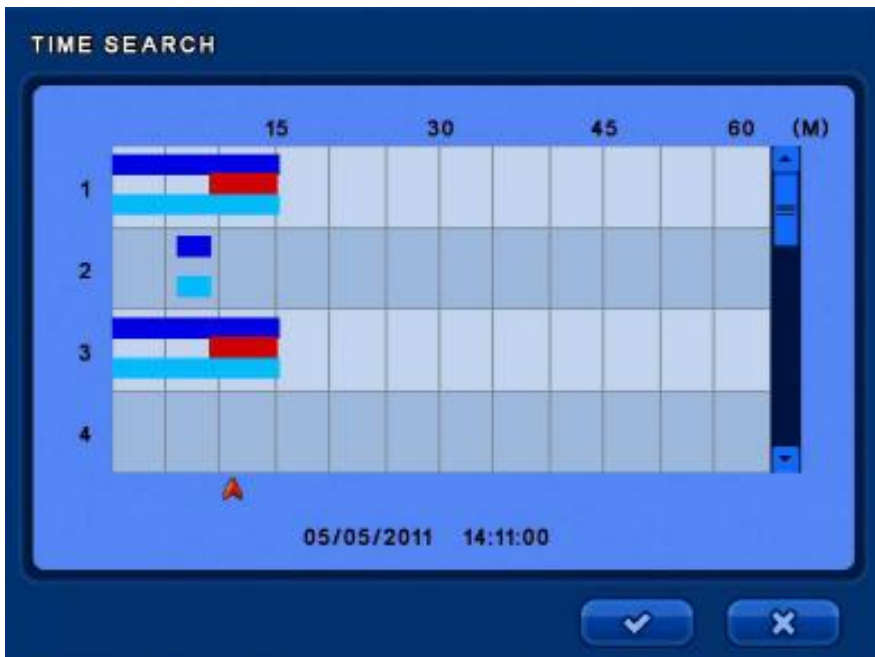

- Select the time by the direction button.
  - After select hour, minutes will be appeared.

**NOTE: The time graph color is different by the recording mode.**  
**Continuous Recording = Blue, Audio Recording = Light Blue, Event Recording = Red.**

## 6.1.3 EVENT SEARCH

EVENT SEARCH

EARLIEST RECORD	01/04/2011 17:33:14
LATEST RECORDING	01/04/2011 18:58:28
DATE	01/04/2011
MOTION	ON
ALARM IN	ON
VIDEO LOSS	ON
SELECT CAMERA	ON

VIEW SEARCH LOG

X

- **DATA** : Select Date to search.
- **MOTION** : Select On/Off event for search.
- **ALARM IN** : Select On/Off event for search.
- **VIDEO LOSS** : Select On/Off event for search.
- **SELECT CAMERA** : Select the camera for search.
- **VIEW SEARCH LOG** : Display selected event log.

EVENT SEARCH RESULT

NO.	TIME	DST	CAMERA	EVENT
22	01/04/2011 18:58:50		1	MOTION
21	01/04/2011 18:58:45		1	MOTION
20	01/04/2011 18:58:02		1	MOTION
19	01/04/2011 18:57:35		1	MOTION
18	01/04/2011 18:57:30		1	MOTION
17	01/04/2011 18:57:25		1	MOTION
16	01/04/2011 18:57:22		1	MOTION
15	01/04/2011 18:56:45		1	MOTION
14	01/04/2011 18:56:32		1	MOTION
13	01/04/2011 18:56:26		1	MOTION

◀ 0 - 18 HOUR ▶

PREV NEXT GOTO

✓ X

- **HOURL** : Select time period to see.
- **PREV** : Display previous page.
- **NEXT** : Display next page.
- **GOTO** : Display the image by selected event.



## 6.1.4 OVERLAPPED LIST



- If user change the time or applied DST (Daylight Saving Time), there will be overlapped data.

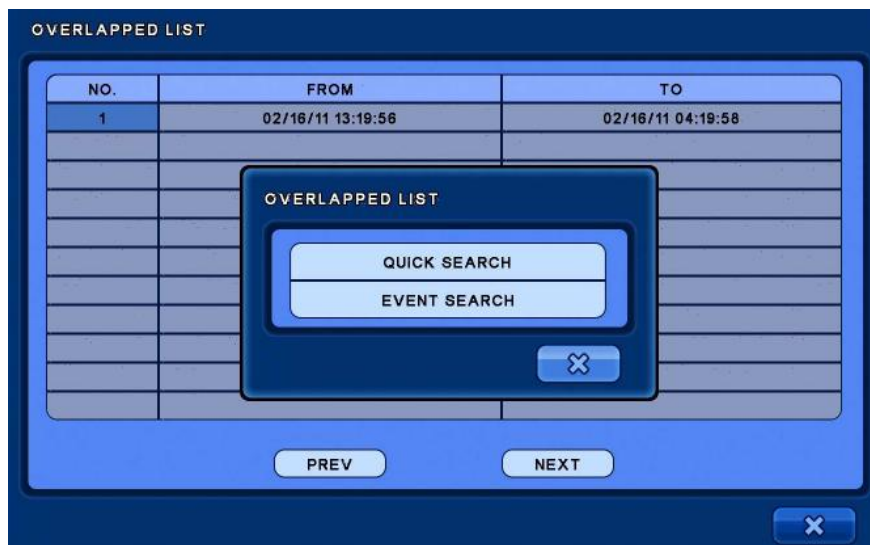

- After select the list, if select the [PLAY] button, can search [QUICK SEARCH] or [EVENT SEARCH].

## 6.1.5 PANORAMA SEARCH

- During normal search, press the [PANORAMA] button.
- By mouse, click the right mouse button and click the [PANORAMA] Search.
- Playback with frame by frame.



## 6.1.6 SMART SEARCH

- During normal search, press the [SMART] button.
- Find only event and playback automatically without interval.



## 6.1.7 SECTION REPEAT SEARCH

- During normal search, press the [LOCK] button.  
When press one time, the start position is set, press one more time, the end position is set.
- By mouse, click the below red circle button.
- Only playback the set section repeatedly.



- In search screen, display the following mark.

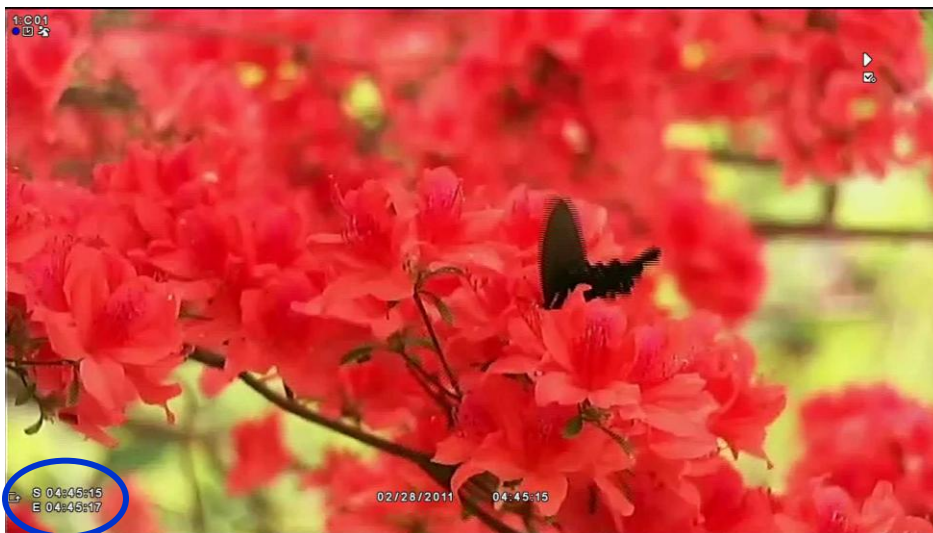

## ※ Button Explanation in Search mode

- Remote Controller or Front button

Button	Explanation
<b>SEARCH</b>	Display the [SEARCH] menu.
<b>ESC</b>	Cancel the Search mode or return to the live screen.
<b>ENTER</b>	Select the CAMEO menu.
<b>FAST REVERSE</b>	When reverse play, up and down play speed.
<b>FAST FORWARD</b>	When forward play, up and down play speed.
<b>PAUSE</b>	Pause the playback.
<b>FORWARD PLAY</b>	Playback the data.
<b>REVEERSE PLAY</b>	Reverse Play the data.
<b>DISPLAY</b>	Display division screen. (1,4,9,16)

# 7. BACKUP

On the Top menu, select the [BACKUP] menu.



After select the menu, the following Log-in window will be appeared.

LOGIN

ID	root				
PASSWORD	****				
0	1	2	3	4	←
5	6	7	8	9	

✓ ✕

Enter the password by the key buttons and press the ENTER button.

(The default password : 1111)

MANUAL BACKUP

TARGET	NONE	NONE
FROM	05/05/2011	13:30:05
TO	05/05/2011	14:17:33
BACKUP TITLE	backup	
SELECT CAMERA	ON	
EARLIEST RECORD	05/05/2011 13:30:05	
LATEST RECORD	05/05/2011 14:17:33	
REQUIRE SPACE	ESTIMATE	0.00MB

WRITE

✕

- **TARGET** : Select the device to backup. (USB / DVD)
- **FROM** : Select the start date and time.
- **TO** : Select the end date and time.
- **BACKUP TITLE** : Type any title.
- **SELECT CAMERA** : Select the camera for backup
- **EARLIEST RECORD** : Display the earliest record.
- **LATEST RECORD** : Display the earliest record.
- **REQUIRE SPACE** : Display the data capacity for selected data.
- **WRITE** : Start the backup.

## 7.1 Play with backup data

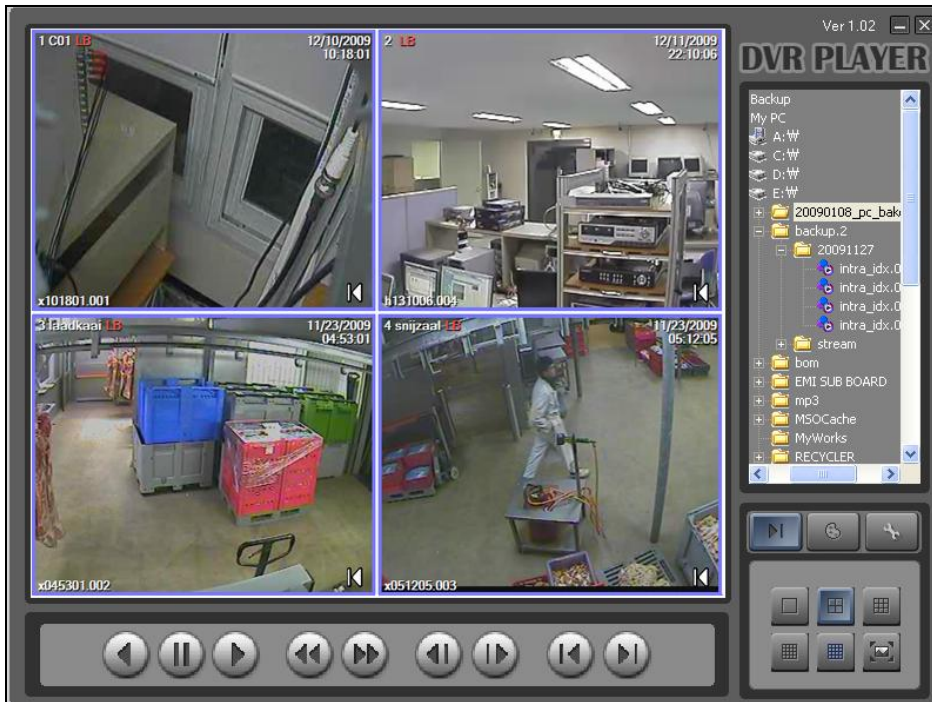

- After backup, the DVR Player is copied with data.
- Backup data only can be played on DVR Player at PC.
- Can export to JPEG still shot.

# 8. APPENDIX

## 8.1 Firmware Upgrade

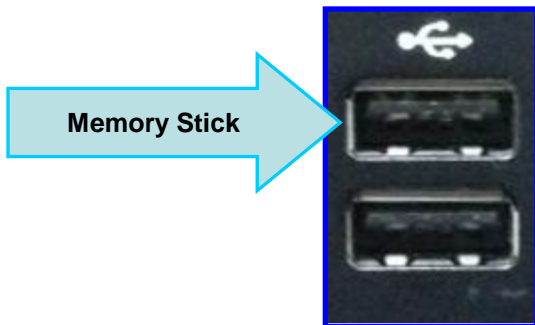

① Copy the firmware on USB and connect on the USB A (Up) port.

※ The USB should be connected on USB A (Up) port otherwise can not upgrade.

② For upgrade, restart the DVR.



③ After restart, when upgrade window is appeared, select the START button.



⑤ After upgrade, remove the USB and select OK button. Then DVR is restarted.

※ If select OK button without removing USB, DVR upgrade is started again after restart.



⑥ After restart DVR, can check that upgrade is finished.

# 8. APPENDIX

## 8.2 Web Client

### ※ How to connect

*For using web connection through internet, 7000 and 80 ports should be set as port forwarding at the Router.*



1. To connect Web viewer, the [Ethernet] setup on DVR is required firstly.

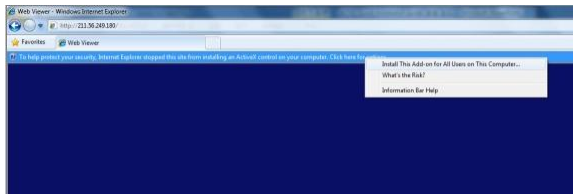

2. Input the IP address or Domain name of DVR

- <http://210.58.xx.xx>
- <http://test.ddnsdvr.com>
- In case of other Web port, input the address as <http://test.ddnsdvr.com:XXXX> ('XXXX' is assigned web port number)

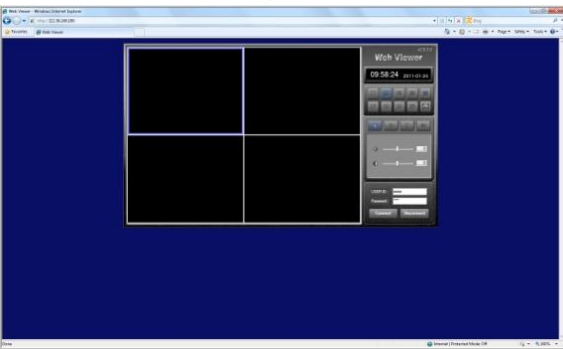

3. User Have to allow download ActiveX

- \* In case of Windows not allow to download the ActiveX, Go to the Security Tab on IE and check all ActiveX to Enable.

4. Install the ActiveX



5. Input ID & Password then click the Connect button.



## 8.2.1 Web viewer Functions

The screenshot shows the 'Web Viewer v2.5' interface. It features four camera feeds: '1 C01 A' (hallway), '2 C02 A' (locker hallway), '3 C03' (restaurant), and '4' (outdoor pool). The control panel on the right includes a clock (11:29:06), a 'Division screen' button, four numbered function buttons (1-4), brightness and contrast sliders, a login section with 'USER ID: remote' and 'Password:' fields, and 'Connect' and 'Disconnect' buttons.

Labels on the right side of the interface:

- Division screen
- 1
- 2
- 3
- 4

Labels below the interface:

- Connect
- Disconnect

Detailed views of the numbered control buttons:

- 1**: Control panel with buttons for Home, PTZ, Alarm, and Play/Pause, and sliders for Brightness control and Contrast control.
- 2**: PTZ control panel with a 4-way directional pad and Zoom In (+) and Zoom Out (-) buttons.
- 3**: ALARM control panel with four alarm status buttons.
- 4**: SEARCH control panel with playback controls (Previous, Play/Pause, Next) and Open data and Exit Search buttons.

# 8. APPENDIX

## 8.4 Specification

Model		HT-1600	HT-800	HT-400	HTL-400
<b>Performance</b>		PENTAPLEX			
<b>Display Speed</b>		Real-Time			
<b>Recording Speed</b>	<b>Max. (1080)</b>	120 fps	120 fps	120 fps	30 fps
	<b>Max. (720)</b>	240 fps	240 fps	120 fps	60 fps
<b>Video In</b>	<b>Signal Level</b>	HD-SDI (SMPTE292M)			
	<b>Channel</b>	16 Ch (BNC)	8 Ch (BNC)	4 Ch (BNC)	4 Ch (BNC)
<b>Video Out</b>	<b>Main Display</b>	HDMI			
	<b>Main Display Resolution</b>	1920x1080(P) / 1920x1080(I) / 1280x 720(P) / 1440x900			
	<b>Sub Display</b>	VGA			
	<b>Spot</b>	HDMI (Multi Channel Display) / HD-SDI (SMPTE292M)			
<b>Audio</b>	<b>Input / output</b>	16 / 1	8 / 1	4 / 1	4 / 1
<b>Alarm</b>	<b>Input / output</b>	16 / 2	8 / 2	4 / 1	4 / 1

### Details

<b>Screen</b>	<b>Display Split</b>	1, 4, 7, 9, 10, 13, 16	1, 4, 7, 9	1, 4	1, 4
	<b>Interface</b>	Graphic User Interface			
<b>Video</b>	<b>Format</b>	1080 /720 Auto detection			
	<b>Codec</b>	H.264 Advanced			
	<b>Recording type</b>	Schedule / Continuous / Event (Motion, Alarm)			
<b>Storage</b>	<b>Interface type</b>	SATA II			
	<b>HDD / Capacity</b>	Up to 9 HDD's			Up to 4 HDD's (+DVD)
<b>Connectors</b>	<b>USB port</b>	USB port * 2			

### Function

<b>Live Display</b>	<b>OSD</b>	On / Off			
	<b>Border Color/ Digital Zoom</b>	Selectable / Up to 4X			
	<b>Cameo</b>	Camera Adjustment / Camera position change / Freeze / Audio on			
<b>Motion</b>	<b>Area</b>	Adjustable GRID (22 X 15)			
	<b>Sensitivity</b>	5 Level motion detection			
<b>System</b>	<b>Hidden Video</b>	Video is hidden in Live view but it is recorded			
	<b>Private Zone</b>	Block the private zone in live camera view			
	<b>Auto Time Synch</b>	By NTP (Network Time Protocol)			
	<b>Firmware Update</b>	Via USB & Network			
	<b>SMART Alarm</b>	Auto Detect & Monitoring HDD's problem			
<b>Event</b>	<b>Source</b>	Motion / Alarm In / Video loss			
	<b>Action</b>	E-Mail notification, Log Send message to Remote, Buzzer, Pop Up, Alarm out, PTZ preset			
	<b>Pre/Post Alarm</b>	Yes (Up to 60 sec / Up to 100 sec)			
<b>Record</b>	<b>Resolution</b>	By each camera for different resolution setting (CIF/2CIF/D1)			
	<b>Quality</b>	4 Levels ( Low / Normal / High / Highest )			
<b>Search</b>	<b>Quick / Event search</b>	Search by time with calendar / Search by event			
	<b>Repeat search</b>	Select specific time period and playback repeatedly			
	<b>Panorama search</b>	Frame by frame			
	<b>Smart search</b>	Search only event and playback without interval			
	<b>CAMEO</b>	Live monitoring during playback, Playback camera change, Freeze and Digital zoom			
<b>Backup</b>	<b>file format / Media</b>	DVR Format / DVD or USB device			
<b>Network</b>	<b>Protocol</b>	Static IP, DHCP, DDNS			
	<b>Physical / Mac Layer</b>	RJ45 (10/100/1000 Mbps), Ethernet			
	<b>Browser</b>	SMS, Web Viewer, Smart Phone Viewer (Android, I-phone)			

### Environment

<b>Operating Temperature / Humidity</b>	0~40℃ / 20~80% RH
<b>Dimension / Weight</b>	440(W) X 480(D) X 132(H) / 14Kg (without HDD)
<b>Power Requirement / Consumption</b>	AC 100V – 220V (50Hz-60Hz) / 500W

# 8. APPENDIX

## 8.5 Trouble Shooting

SYMPTOM	MEASURES
<p><b>No Power</b></p>	<p>If the power LED is not lighted, check the below items.</p> <ul style="list-style-type: none"> <li>- Check the power plug and outlet. (Refer to the [Cautions for safety])</li> <li>- Connect the power cord to the power connector of DVR properly.</li> </ul>
<p><b>No camera image</b></p>	<ul style="list-style-type: none"> <li>- Connect the camera cable to the DVR port properly.</li> <li>- Check the connected monitor cable with DVR. (Refer to the <b>[Rear Panel Configuration]</b>)</li> <li>- Check the camera power and lens setting.</li> <li>- As this may be caused by a temporary error, restart DVR.</li> <li>- As camera setting may be wrong, initialize the camera and DVR.</li> </ul> <p>※ <b>How to initialize DVR</b></p> <p><b>1. Main Menu &gt; Configuration &gt; Default Load &gt; O.K &gt; O.K</b></p> <p><b>!! Caution: After DVR initialization, DVR setting is returned factory default. Need to backup the configuration before initialize DVR.</b></p>
<p><b>Not work mouse</b></p>	<ul style="list-style-type: none"> <li>- USB mouse should be supported PS/2. Check the PS/2 support.</li> <li>- Mouse should be connected on port (B) properly. (Refer to the <b>[Front Panel Configuration]</b>)</li> <li>- Reset the USB Mouse. (Set on <b>[System Manager]</b>)</li> </ul>
<p><b>Not record on DVR</b></p>	<p>If the recording LED does not flicker, check the below items.</p> <ul style="list-style-type: none"> <li>- HDD should have enough space otherwise could not be recorded.</li> <li>- Delete data in HDD or change the [HDD OVERWRITE] setting to [ON]. (Refer to the <b>[GENEL Setup] – [HDD OVERWRITE]</b>)</li> <li>- Replace the HDD because the HDD may be failed.</li> <li>- Check the recording setup.</li> </ul>
<p><b>Not connected Network</b></p>	<p>If the network LED does not flicker, check the below items.</p> <ul style="list-style-type: none"> <li>- Check the connected hub or router.</li> <li>- Check the network cable and connection.</li> <li>- Check the network setup.</li> </ul>

<p><b>Not work remote controller</b></p>	<ul style="list-style-type: none"> <li>- Check the battery polarity.</li> <li>- Check the remote controller ID. (Refer to the <b>[Remote Controller Configuration]</b>)</li> <li>- Focus on the remote controller to the IR sensor.</li> <li>- Use the remote controller within 7 meters from DVR.</li> <li>- Change the battery.</li> </ul>
<p><b>No sound in live view</b></p>	<ul style="list-style-type: none"> <li>- Check the mike and audio cable with DVR port. (Refer to the <b>[Real Panel Configuration]</b>)</li> <li>- Check the speaker power which is connected on Audio port.</li> <li>- Turn on the Audio in the CAMEO menu. (Select the channel which is connected Audio and turn on. <b>※ CAMEO menu will be appear when click the right button of mouse.</b>)</li> </ul>
<p><b>No sound in search</b></p>	<ul style="list-style-type: none"> <li>- Set to [Audio] – [ON]. (If set to [OFF], sound is not heard during search.)</li> <li>- Although the record icon is lighted, if there is no audio input, sound is not heard. <b>※ Audio record can be changed [Main Menu] &gt; [Record Setup].</b></li> </ul>
<p><b>Not work smart search</b></p>	<ul style="list-style-type: none"> <li>- For smart search, event record should be set.</li> <li>- If event record is not set, when select the smart search, return to the live screen from search mode.</li> </ul>