IR Intelligent High Speed Dome Camera

User Manual

※ Read the manual carefully before use, please take care of it for instant consult. (B)

Content

chapter 1 foreword	2
chapter 2 product summarize	4
2.1 product profile	4
2.2 capability feature	4
2.3 function description	5
2.4 English menu index	7
2.5 technical parameters	8
2.6 quick operation guide	8
chapter 3 installation	8
3.1 dome camera DIP switch setting	9
3.1.1 enter to DIP switch setting	9
3.1.2 DIP switch setting	10
3.2 installation of IR&intelligent speed dome	12
3.2.1 the sizes of dome and bracket	错误!未定义书签。
3.2.2 the installation of dome and bracket	13
chapter 4 basic operation of dome	13
chapter 5 menu setting	错误!未定义书签。
5.1 main menu	错误!未定义书签。
5.2 < CAMERA SETTINGS > (zoom parameters setting)	错误!未定义书签。
5.3 < DOME SETTINGS > (dome setting)	错误!未定义书签。
5.4 < FUNCTION SETTINGS > (function setting)	18
5.4.1 < PRESET SETUP > (presets setting)	19
5.4.2 < TOUR SETTINGS > (cruise setting)	错误!未定义书签。
5.4.3 < SCAN SETTINGS > (scanning setting)	20
5.4.4 < PATTERN SETTINGS > (patrol track setting)	21
5.5 SYSTEM SETTINGS (system setting) menu	22
5.5.1 DISPLAY SETTINGS (show setting) :	22
5.6 CLEARANCE SETTINGS (eliminate setting) :	23
5.7 SPECIAL_FUNC MENU (special function menu) :	23
5.7.1 IR SYSTEM SETUP (IR system setting) :	24
chapter 6 Simple fault clearing form and maintain	25
6.1 Simple fault clearing form	25
6.2 notes	25
6.3 aftersales service	26

Chapter 1 Foreword

At the start of the installation and use of infrared intelligent high-speed dome (hereinafter referred to as "dome") before, please read the following information:

1. Before installation, please read carefully the product manuals and installation guide.
2. Do not put products in unstable plane test, such as the installation of operation, in before operation to ensure the machine put smoothly and assembly firmly.
3. Transportation and storage process to prevent stress, violent vibration and soaking etc of product damage.
4. This product will not reversed installation; For high-speed dome to handled with care, don't push hard on the various structural components, or it may cause a mechanical problem, affects the high-speed dome overall performance. High-speed dome lens front transparent material belongs to advanced optical materials, avoid to use the hand directly touch, lest cause scratches, affects the image quality.
5. Do not send any solid object or fluid substance penetrated machine, lest damage machine.
6. Wiring must observe the electrical safety standard, use this machine to bring special power supply. This product rs-five 485 video signal and using TVS level prevent lightning technique can effectively prevent 500W below power by lightning, surge and other kinds of pulse signal of equipment damage. Video signal rs-five 485 and during transmission with high pressure equipment or cable should keep sufficient distance, when necessary even prepare necessary lightning, prevent surge protection.
7. Whether used or not in use, never can make camera aimed at the brightness of the sun or other objects. Or you could make CCD permanent damage.
8. Don't use it beyond standard of environmental temperature, humidity.
- 9 in this product within and no user serviceable parts. When the machine is a fault, not easily to machine any repair operations, should first and specifications found fault, find no fault reason is ask professional maintenance. Relevant maintenance work, must by my company authorized maintenance inspection organizations

Chapter 2 Product summarize

2.1 Product introduction

Infrared intelligent high-speed ball is used in today's latest of scientific and technological achievements, the sophistication of manufacturing process, Comprehensive years of experience of the successful development of automatic zoom lens, configuration of high-performance digital signal processing (DSP) camera, Set the built-in yuntai and digital decoder integrated, represents a new generation of high technology to monitor the product development trend. It adopts full digital control, mechanical exquisite design simple, can be arbitrary quickly positioning and continuous tracing scanning, with automatic tracking the camera, realizing function in the true sense of all-round, without the blind spot of the intelligent surveillance, Can automatically adapt to the environment of light and shade and target near-far changes, High reliability, long and stable operation, maintenance unnecessary.

Infrared intelligent high-speed ball combines various control protocol, can support a variety of popular system platform. With other system matching, each system connection and method of use not identical, here do not specify, please contact the relevant system manufacturer or dealer contact to get necessary information.

Infrared intelligent high-speed ball of various characteristics of large area, applicable to all walks of life activities target surveillance. Such as power systems, telecom departments, bank security, mines, intelligent building, intelligent community, city road monitoring, airports, railway stations, etc as security monitoring situation, and the fire monitoring system of image monitoring equipment.

2.2 Performance characteristics

1. Built-in OSD English onscreen menu, via the menu to display and change the ball machine information and parameters can be set and call preset point, figure scanning, regional scanning and display area, etc.
2. Integrated design, compact structure, high reliability.
3. 255 preset points.
4. Adopt RS485 bus control.
5. Precision of motor drive, smooth operation, sensitive reaction.
6. Level 360 ° continuous rotation, no monitoring blind spots.
7. Rotation speed camera variable times according to automatically adjust multiples,
8. 90 °, automatic vertical flipping 180 ° after continuous monitoring.
9. Automatic focus, automatic white balance.
10. Backlighting compensation function, have strong illuminant environment can see all the objects.
11. Combines various control protocol, baud rate is adjustable.
12. Wide dynamic camera support (SONY1010, SONY990) SONY490,

2.3 functional specifications

Below briefly introduce infrared intelligent high-speed ball's main function, and describes the various functions and operating the general principles, don't involve concrete operating methods.

1 set address coding, baud rate, control protocol

Any operation command has its target camera address coding, baud rate, control protocol, single camera

just response to their own address coding, baud rate, control protocol consistent operation orders. Camera address coding, baud rate, control protocol specific setting methods please refer to dial the code Settings.
2 the target tracking.

The user can use the control on keyboard rocker control the camera up, down, left and right rotation, could be used to track a moving target or mobile horizon, another can adjust focal length to change perspective size or target image size. In automatic focus condition, with the rotation of the lens, cameras automatically on the scenery changing quickly adjust, instant get a clear picture.

3. Focal length/speed automatic matching technology

Manual adjustment, focus the long ball machine, high-speed reflect make slight touches rocker may makes the picture is moving, thereby causing loss of data. Based on the humanized design, intelligent ball focal distance according to automatically adjust camera horizontal and vertical speed, make manual operation is more easy target tracking.

Automatic flip 4.

The operator will lens pull bottom (vertical) if you still hold rocker, right now lens level automatically rotate for 180 ° immediately after 90 °, upturned blade can be directly to watch on the back of the scenery, so as to realize the longitudinal 180 ° throughout the continuous monitoring.

5. Setting and call preset position

Presets feature is the ball under the current state of functions of the horizontal Angle, yuntai Angle and camera position such as parameters storage focal length into memory, when need can rapidly and will call these parameters to adjust the yuntai and camera position. The operator can be quickly through controlling the keyboard, infrared controller etc control equipment storage and calling the preset point, ball machine support 255 preset points.

Lens control 6.

(1) the focal length of control

Users can through ball machine control keyboard or matrix host zooming unhealthily, to obtain the required a panoramic view of the screen, or are subtle view.

(2) focus control

The system default auto-focusing, zoom, a camera in the center of autofocus scenery pictures, keep clear image; Under special circumstances, the user can manual focus to hope image effects.

When exposed to manual focus condition, to restore auto-focusing, just shake analog stick can recover automatic focus. Another can also send special control command or call an arbitrary preset bits of recovery auto-focusing method.

A camera under the following circumstances will not be able to camera target auto-focusing:

- A. goal is not a picture center;
- B. targets at the far and near the place,
- C. target for light objects, such as luminous objects such as NaiDeng, spot,
- D. goal in with water or dust behind glass,
- E. target move too quickly,
- F. area of the target, such as wall,
- G. goal too dark or was vague.

Aperture control. 7.

Users can through controlling the keyboard, manually adjust aperture size, to obtain the required picture brightness.

8. Automatic backlighting compensation

When backlit compensation function opened, the camera can be automatically when light under the background of darker targets brightness compensation. To light the background of daylighting adjustment,

and avoid background illumination and cause the whole picture posse shining, but through dark and target, thus obtains not discern clear images.

9. Auto white balance

According to the environment radial change, automatic adjustment, reproduce true colors.

10. Night vision function (color b&w conversion)

With night vision function of camera, in automatic color b&w conversion mode, can according to the environment of the light changes automatically converts CCD intensity of illumination. Such as: during the day because of the light is enough, use general illumination guarantee colourful picture. But at night can automatically change for a low illumination, with black and white pictures showed clear scenery.

11. Automatic cruise

Through a preset cruise preset point, which will be certain preset click request order to automatic arrangement cruise queue, only one external commands can let indoor medium-speed ball automatically set according to the preset point order defined intervals reciprocating kept movement.

12. Figure scan

Figure scan is through the menu will ball chance done by track storage down on electricity action, free action, alarm linkage, etc to invoke the store scan route.

13. Scanned continuously

Only an external command or through action, free action on electricity, alarm linkage, etc to call, can make the ball with a certain speed machine horizontal continuous cycle scan.

14. Intermittent scan

Only an external command or through action, free action on electricity, alarm linkage, etc to call, can make the ball with a certain speed machine horizontal batch of circulation scan.

15. Regional scan

Only an external command or through action, free action on electricity, alarm linkage, etc to call, can make the ball with certain horizontal machine speed, set range between scan.

16. Wide dynamic

Support SONY newest FCB - EX490, EX990 FCB - FB - EX1010 wide, dynamic camera, applicable in strong backlight environment of applicable.

2. 4 MENU INDEX

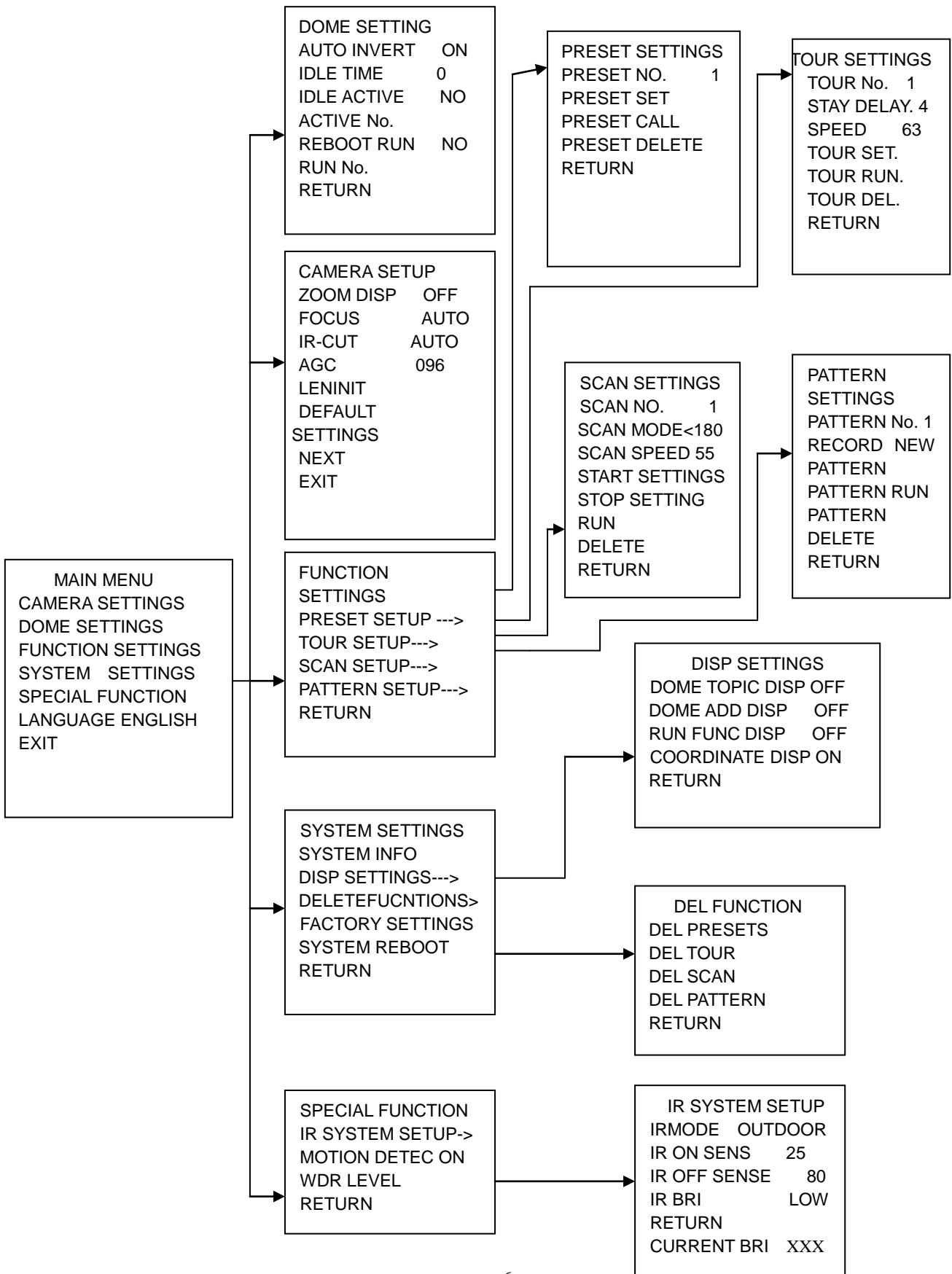

2. 5 Technical parameters

Model	IR high speed dome			
Image sensor	1/3 " CCD			
Signal mode	PAL/NTSC			
resolution	Color 650TVL			
Min illumination	Color to B/W,color0.05Lux,B/W 0.001Lux			
S/N ratio	≥60dB			
Backlight compensation	on/off			
White balance	Auto			
Electronic shutter	1/50 ~ 1/10000 /s			
Focus length	3.9 ~ 85.8mm	3.2 ~ 86.4mm	3.3 ~ 99mm	3.2 ~ 115.2mm
Optical focus	22x	27X	30X	36X
Digital	12X			
Focus	manual/Auto Semi-auto, take high-performance DSP to realize complete digital and ultra-high speed focus function			
presets	255			
Pattern track	4groups,each can record 200 actions			
Tour track	4 tours, 16 presets join tour, the presets' residence time can be set			
Other scan	4 scans, supports >180°and 180°< modes.			
Rotation Range	Horizontal 360°unlimited rotation, vertical 180°,auto invert			
Rotation speed	Horizontal & vertical Min:0.01°/s,Max 300°/s			
IR effect	Distinguish face from 80m, Distinguish body shape from 100m		Distinguish face from 100m, Distinguish body shape from 120m	
Communications	PELCO D and PELCO P			
Menu function	English / Chinese Full screen menu			
Temperature Control	Optional			
Power supply	DC12V/4A		AC24V/3A	
Cover dimension	7inch			
Work Environment	-10℃ ~ +70℃ (select temperature control accessories) , -95%RH			
Material	Metal casting aluminum shell, waterproof IP66			

2. 6 Camera function quick operation guide

Preset Settings

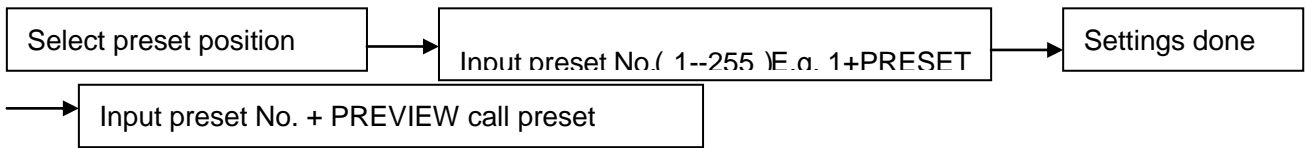

Scan setting

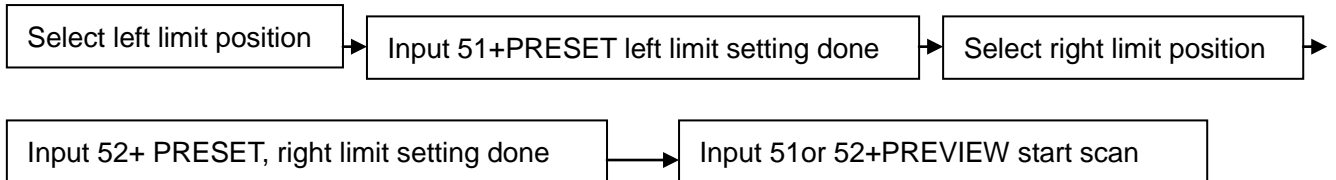

Note: The other three scan can be set in the menu.

Tour setting

Take tour 1 for example

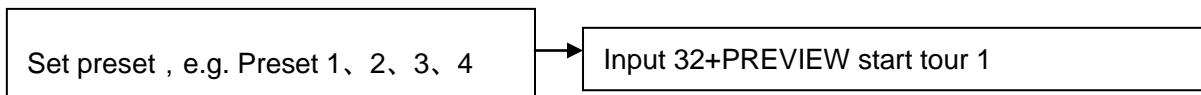

The other three tour, please see <5.4.2 tour setting>.

Pattern setting

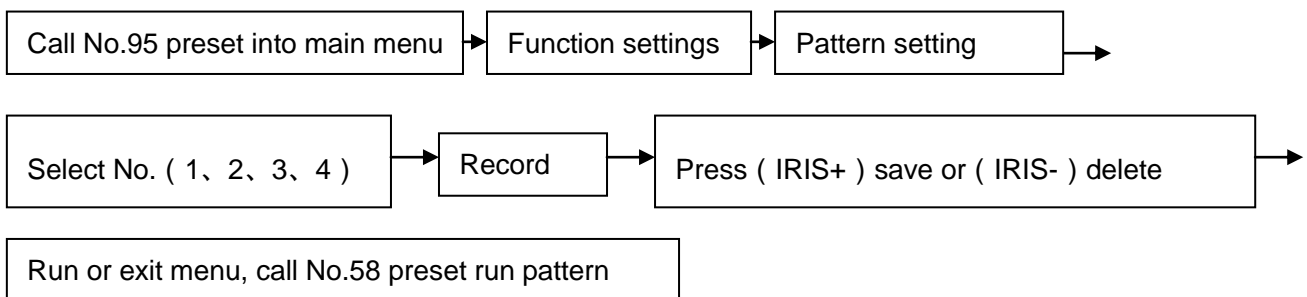

Chapter 3 Installation

3.1 Speed dome DIP switch settings

High speed dome camera is compatible with a variety of control protocols, baud rate can be adjusted to make it compatible with more monitoring and control system. Before install the speed dome camera, please adjust the DIP switch to appropriate code according to your requirements, in order to adjust the baud rate, control protocol, address code. If there are no special requirements, the speed dome factory default address code is 1, baud rate is 2400BPS corresponding code, and control protocol is PELCO-D corresponding code.

3.1.1 Enter DIP switch settings

Change BAUD-RATE, PROTOCOL and ADDRESS through DIP switch. Module, housing and DIP switch pictures see picture 1,



picture 3-1

SW1 switch : Baud rate and control protocol switch

SW2 switch : Address DIP switch

Dial the code switch to "ON" means "1", dial the code switch to "OFF" means "0", dial the code switch ON the left and right for low to high

Baud rate and control protocol Settings list:

SW1					
Number	1	2	3	4	
Control protocol	OFF	OFF			PELCO-P/D self-adaption
	ON	OFF			PELCO-P/D self-adaption
	OFF	ON			Save
	ON	ON			Save
Baud rate (BPS)			OFF	OFF	2400
			ON	OFF	4800
			OFF	ON	9600
			ON	ON	19200

2. SW2 Switch sets the ball machine address coding. Address set by binary mode, total can set 255 different address coding, see ball machine address coding sheets. Factory default Settings as shown in figure 2.

Dome address	SW2dome address encode table							
	1	2	3	4	5	6	7	8
0	OFF	OFF	OFF	OFF	OFF	OFF	OFF	OFF
1	ON	OFF	OFF	OFF	OFF	OFF	OFF	OFF
2	OFF	ON	OFF	OFF	OFF	OFF	OFF	OFF
3	ON	ON	OFF	OFF	OFF	OFF	OFF	OFF
4	OFF	OFF	ON	OFF	OFF	OFF	OFF	OFF
5	ON	OFF	ON	OFF	OFF	OFF	OFF	OFF
6	OFF	ON	ON	OFF	OFF	OFF	OFF	OFF

7	ON	ON	ON	OFF	OFF	OFF	OFF	OFF
8	OFF	OFF	OFF	ON	OFF	OFF	OFF	OFF
9	ON	OFF	OFF	ON	OFF	OFF	OFF	OFF
10	OFF	ON	OFF	ON	OFF	OFF	OFF	OFF
11	ON	ON	OFF	ON	OFF	OFF	OFF	OFF
12	OFF	OFF	ON	ON	OFF	OFF	OFF	OFF
13	ON	OFF	ON	ON	OFF	OFF	OFF	OFF
14	OFF	ON	ON	ON	OFF	OFF	OFF	OFF
15	ON	ON	ON	ON	OFF	OFF	OFF	OFF
16	OFF	OFF	OFF	OFF	ON	OFF	OFF	OFF
17	ON	OFF	OFF	OFF	ON	OFF	OFF	OFF
18	OFF	ON	OFF	OFF	ON	OFF	OFF	OFF
19	ON	ON	OFF	OFF	ON	OFF	OFF	OFF
20	OFF	OFF	ON	OFF	ON	OFF	OFF	OFF
21	ON	OFF	ON	OFF	ON	OFF	OFF	OFF
22	OFF	ON	ON	OFF	ON	OFF	OFF	OFF
23	ON	ON	ON	OFF	ON	OFF	OFF	OFF
24	OFF	OFF	OFF	ON	ON	OFF	OFF	OFF
25	ON	OFF	OFF	ON	ON	OFF	OFF	OFF
26	OFF	ON	OFF	ON	ON	OFF	OFF	OFF
27	ON	ON	OFF	ON	ON	OFF	OFF	OFF
28	OFF	OFF	ON	ON	ON	OFF	OFF	OFF
246	OFF	ON	ON	OFF	ON	ON	ON	ON
247	ON	ON	ON	OFF	ON	ON	ON	ON
248	OFF	OFF	OFF	ON	ON	ON	ON	ON
249	ON	OFF	OFF	ON	ON	ON	ON	ON
250	OFF	ON	OFF	ON	ON	ON	ON	ON
251	ON	ON	OFF	ON	ON	ON	ON	ON
252	OFF	OFF	ON	ON	ON	ON	ON	ON
253	ON	OFF	ON	ON	ON	ON	ON	ON
254	OFF	ON	ON	ON	ON	ON	ON	ON
255	ON	ON	ON	ON	ON	ON	ON	ON

3.2 installation of IR&intelligent speed dome

3.2.1 the sizes of dome and bracket

Product diagram 3-1



picture 3-2

The dimension of bracket 3-2

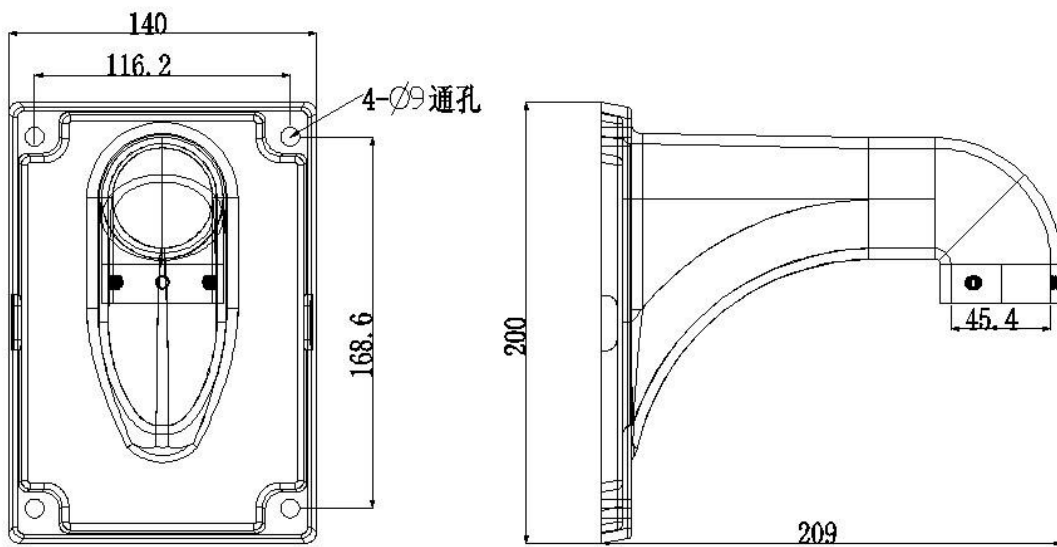

picture 3-3

3.2.2 the installation of dome and bracket

Step 1 : the installation of bracket



picture 3-4 Determine the screw holes position



picture 3-5 drilling In the position



picture 3-6 drilled the holes



picture3-7 Tighten the screw

In stay on the wall of ball machine installation, according to determine the installation position stent screw holes position with signal pen on wall draw hole position as shown in FIG. 3-3. On wall drilling as shown in figure 3-4. The expansion bolts into the hole, Will cable through stents, then on the support screw holes on the nuts tighten the screw, as shown in figure 3-6.

Step 2: the ball machine installation

Stents three screw loose on the cover, the ball will be machine head alignment teams, tighten the scaffolds overhead into three fixed screw, in case the ball machine off.

chapter 4 basic operation of dome

Due to the different system platform specific operation method, generally should not identical with system manufacturer operation manual shall prevail, different circumstances

will have special requirements and operation method, please contact with dealers get necessary information. Here only introduced connection this company produces the control keyboard, of ball machine control method.

1. Self-checking electrify.

Ball machine after electrify, camera first horizontal and vertical direction automatically after the sports, in lens to pull recently, and down after the farthest stop. Through self-check determine ball machine running normally.

Control the camera up, down, left and right rotation:

When choosing a camera, can pass the keyboard rocker manual control ball machine up, down, left and right movement. The camera shake control lever of action, when rocker to right when they are shaken, the camera also to the right in the northern hemisphere. Likewise, when joystick left when I shake the camera also left movement. Rocker vertical direction when they are shaken, camera also follow the corresponding action do vertical direction. According to the diagonal direction when shaken rocker, can let a camera while doing the horizontal and vertical direction of movement and movement direction and rocker consistent.

2 . Presets setting

According to the following steps to set preset :

- (1) select the camera (more information please read control of the keyboard manual);
- (2) operation joystick, zoom button, focus button, IRIS buttons adjust the camera picture images;
- (3) Press the number key +PRESET (Enter the specified preset), save the preset scene parameters.

3 . Call preset

Follow the below step to watch the preset:

(1) select the camera ;

(2) Press the number key +PREVIEW (enter the designated preset), the camera move to the preset position immediately, the lens zoom, focus and aperture is also automatically change to the preset parameters; if the input is a special function of the preset (see "Preset function menu"), the speed dome camera will perform with special features preset of the corresponding functions (such as: Enter the 97/99 preset, the camera auto-tracking feature).

Preset function list

<u>CALL COMMANDS</u>	<u>EXECUTE FUNCTION</u>
<u>CALL 64/95 PRESETS</u>	Enter dome camera menu
<u>CALL 57 PRESETS</u>	Enter CAMERA menu
<u>CALL 56 PRESETS/IRIS-</u>	Force exit menu
<u>CALL 97/99 PRESETS</u>	Start automatic scan
<u>CALL 96 PRESET OR OTHER PTZ CONTRONL</u>	Close automatic scan
<u>CALL 32 PRESETS</u>	Start Tour function 1

<u>CALL 53 PRESETS</u>	Start Tour function 2
<u>CALL 49 PRESETS</u>	Start Tour function 3
<u>CALL 50 PRESETS</u>	Start Tour function 4
<u>CALL 58 PRESETS</u>	Pattern scan 1
<u>SET 51 PRESETS</u>	Set left/ right scan 1 -start
<u>SET 52 PRESETS</u>	Set left/ right scan 1 -end
<u>CALL 51 PRESETS</u>	Call left/ right scan 1
<u>CALL 52 PRESETS</u>	Call left/ right scan 2
<u>CALL 93 PRESETS</u>	System restart
<u>CALL 94 PRESETS</u>	Recover the factory parameters
<u>CALL 59 PRESETS</u>	Started four combinations Tour function (Tour preset expand to 64 pcs)
<u>CALL 103 PRESETS</u>	Infrared lamp automatic outdoor mode(1x-7x,all Infrared lamp open. after 7x,only external circle Infrared lamp open. internal infrared lamp close)
<u>CALL 104 PRESETS</u>	Infrared lamp automatic indoor mode(1x-7x,only internal Infrared lamp open. after 7x,only external circle Infrared lamp open)

4.close-up lens and wide-angle lens

Adjust the camera lens variable times pull away or close, to enlarge or reduce scenery to feature and wide-angle effect. press ZOOM+ , camera scene will be near, and the object on the camera image will be 14 zoom in. press ZOOM- ,camera scene will be far, and the object on the camera image will be zoom out. if you quickly press and loose variable times buttons, the camera images which is on the monitor will be a little changed. the camera variable times changed is depend on pressing the length of time of buttons.

5 . Lens focus control

Focus is a process that adjusting one of camera image and scen' s resolution. Press FOCUS+, the long distance of object or scene will be more clear, short distance of object and scene will be fuzzy, press FOCUS- ,short distance of object and scene will be clear, long distance of object will be fuzzy. Repeated adjustment focus on key until the object which one on the monitor is from fuzzy to clear. The same with the variable times, the camera's focus changed is depend on focus pressed length of time.

6. Manual iris function

IRIS changed the brightness level of camera images, press IRIS+ ,camera image brighten, press ,camera image will darken. it's same with the buttons of variable times, camera's bright and dark are depend on length of time you pressing the IRIS buttons. Chapter 4 menu setting This chapter will be detailed introduction of OSD menu. Switch on

the power, the dome camera, after self monitor screen will show the following information:

chapter 5 menu setting

This chapter will detail OSD menu operation. Switch on the power, ball machine, after the monitor screen self-checking admiral are shown in the following information:

VERSION : V10.06B

PROTOCOL : PELCO-P/D

BAUD RATE : 2400

CAMERA ID : 1

HORIZONTAL CHECK OK

VERTICAL CHECK OK

CAMERA CHECK OK

These messages will always show the dome camera till self-checking finished.

Due to the different monitoring system for the dome camera is not identical operation method, the specific operation please contact with dealers. The following simple introduction to use keyboard control operation of OSD menu.

1. Enter main menu: CALL No.64/ 95 preset, and you will enter OSD main menu. shake left /right FOCUS+ /FOCUS-Is the enter key. IRIS- (iris close) is the exit key
- 2 . Enter other menu : Up / down shake the joystick, so that the cursor is pointing to a menu , press FOCUS+ enter the menu.
- 3 . Function select : Up / down shake the joystick or press ZOOM+ / ZOOM-, so that the cursor is pointing to a menu , press FOCUS +select this function.
- 4 . Parameter select : Up / down shake the joystick or press FOCUS+/ FOCUS- to select the parameter
- 5 . Restore settings : Press IRIS+ ,restore the settings , it is effective if has corresponding prompt.
- 6 . Does not restore and back to last menu: press IRIS- back to last menu, it is effective if has 15 corresponding prompt.
- 7 . Exit menu: Up / down shake the joystick , so that the cursor is pointing to exit option, press IRIS +exit OSD menu.
- 8 . Back to previous menu : Up / down shake the joystick, so that the cursor is pointing to

back option , press FOCUS +and back to previous menu.

Notes : Different speed dome setting, different display on speed dome.

The following is detailed description of use smart standard control keyboard to operate OSD menu.

5.1 Main menu

Speed dome work normally, set No.64/95 preset, enter main menu, screen display is as picture 3.1.

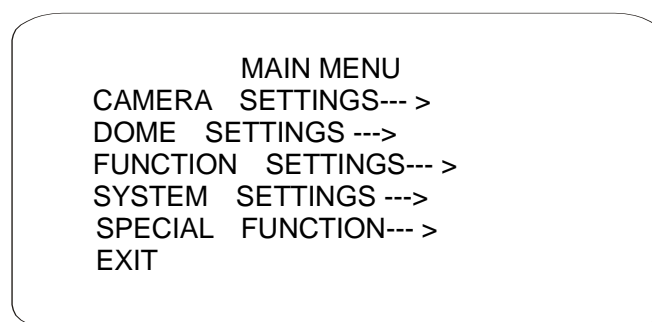

picture 5.1 MAIN MENU

Main menu contents description :

< CAMERA SETUP > :

< DOME SETTINGS > :

< FUNCTION SETTINGS > :

< SYSTEM SETTINGS > :

< SPECIAL FUNCTION > :

<EXIT> :

To enter the menu and execute of the various functions of the basic operation is as follows :

- 1 . On the picture 3.1<MAIN MENU> , Up / down shake the joystick or press ZOOM+/ZOOM- , so that the cursor is pointing to a menu item or function option ;
- 2 . Press FOCUS+ , enter menu or operate a function option.

5.2 < CAMERA SETUP > (zoom parameters setting)

On the picture 3.1<MAIN MENU> , Up / down shake the joystick or press ZOOM+/ZOOM- , so that the cursor is pointing to <CAMERA SETUP> , press FOCUS+ , enter camera parameters setting as picture 3.2<CAMERA SETUP> MAIN MENU

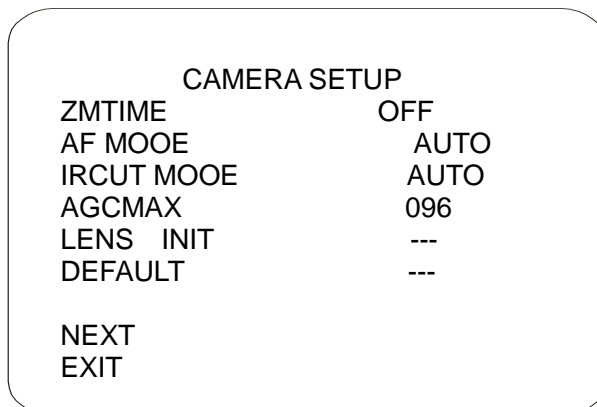

CAMERA SETUP is used to set camera basic information, functions are as below

The first level menu,

ZMTIME: zoom times display, OFF/ON
 AF MOOE: Focus settings, AUTO/MANU/KEYAUTO
 IRCUT MOOE: IR switch, AUTO/ON/OFF
 AGCMAX: Auto gain,096.
 LENS INIT: Lens initialization,---。
 DEFAULT: Default---。
 NEXT: Enter next level menu
 EXIT:

The second level menu

LEN: AUTO/MANUAL
 SHUTTER/AGC: Shutter, auto gain
 WHITE BAL: White balance, AUTO/PUSH/USER1/USER2/ANTI
 CR/MANUAL/PUSH LOSK
 BACKLIGHT: Backlight compensation, OFF/HLC/BLC
 PICT ADJUST: Picture adjustment
 ATR: OFF/ON
 MOTION DET: ON/OFF
 NEXT: Enter next level menu
 EXIT: SAVE ALL:

The third level menu

PRIVACY: OFF/ON
 DAY/NIGHT: AUTO/BW/COLOR
 NR: Noise reduction
 SYNC: TNT---inter sync
 LANGUAGE:
 CAMERA RESET:

BACK:

EXIT: SAVE ALL:

Notice: There are some differences among different models cameras, contact manufacturer when necessary.

5.3 <DOME SETTINGS>

On the picture 3.1 <MAIN MENU> , Up / down shake the joystick or press ZOOM+/ZOOM- , so that the cursor is pointing to <DOME SETTINGS> , press FOCUS+ , enter dome camera setting as below picture3.3 DOME SETTINGS

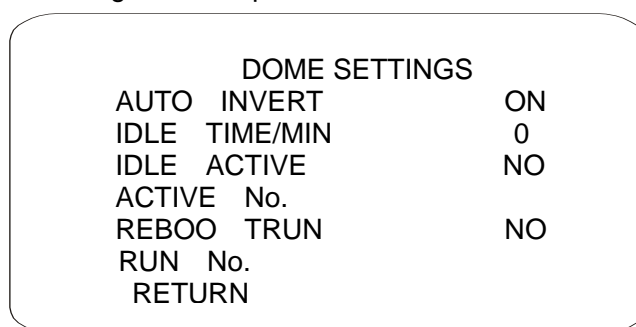

picture 5.3 DOME SETTINGS

On the picture 3.3 DOME SETTINGS , function as below;

DOME SETTINGS

AUTO INVERT ON/OFF

IDLE TIME/MIN :0~255, closed:0

IDLE ACTIVE NO/PRESET/SCAN/PATTERN/TOUR

ACTIVE No.

REBOOT RUN : NO/PRESET/SCAN/PATTERN/TOUR/LAST STA

RUN No.

RETURN

5.4 < FUNCTION SETTINGS >

On the picture <3.1MAIN MENU> ,Up / down shake the joystick or press ZOOM+/ZOOM- , so that the cursors pointing to<FUNCTION SETTINGS> , press FOCUS+ , enter function setting menu as below 3.4< FUNCTION SETTINGS>

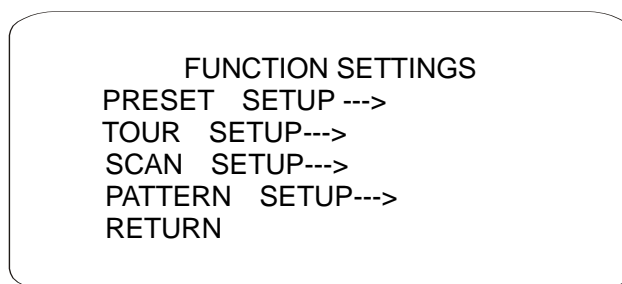

picture 5.4< FUNCTION SETTINGS >

<FUNCTION SETTINGS> menu is used to set functions, functions as below;

<PRESET SETUP> :

<TOUR SETUP> :

<SCAN SETUP> :

<PATTERN SETUP> :

RETURN :

FUNCTION SETTINGS

PRESET SETUP --->

TOUR SETUP--->

SCAN SETUP--->

PATTERN SETUP--->

RETURN

5.4.1<PRESET SETUP>

Presets setting, the specific operation is as follows: On the picture <3.4< FUNCTION SETTINGS >, Up / down shake the joystick or press ZOOM+/ZOOM-, so that the cursor is pointing to<PRESET SETUP>; press FOCUS+, enter as below:

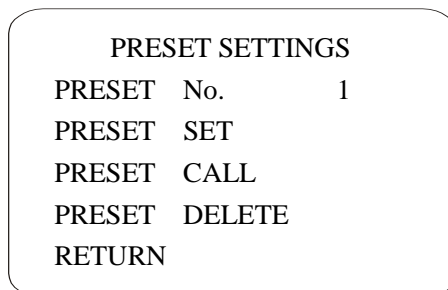

Picture 5.4.1 <PRESET SETTINGS >

< PRESET SETTINGS >menu is used to set presets, Functions description as below;

PRESET No.: the number of presets

PRESET SET: presets setting

PRESET CALL: calling resets

PRESET DELETE: relating resets

RETURN: return

5.4.2<TOUR SETTINGS>(cruise setting)

4.4.2<TOUR SETTINGS>

On the picture<5.4 FUNCTION SETTINGS>, Up / down shake the joystick or press ZOOM+/ZOOM-, so that the cursor is pointing to<TOUR SETTINGS>, press FOCUS+, enter tour settings menu as below;

TOUR SETTINGS		
TOUR	No.	1
STAY	DELAY	4
TOUR	SPEED	63
TOUR	SET	
TOUR	RUN	
TOUR	DEL	
RETURN		

Picture 5.4.2< TOUR SETTINGS >

< TOUR SETTINGS > menu is used to set tour , function as below;

TOUR No.:

STAY DELAY: (S):0~255

TOUR SPEED: 0~63 level

TOUR SET:

TOUR RUN:

TOUR DEL:

RETURN:

TOUR setting is used to set lens auto execute preset track for scanning. the step as below;

1. On the picture <3.4.2< TOUR SETTINGS > , Up / down shake the joystick or press ZOOM+/ZOOM-, so

that the cursor is pointing to <STAY DELAY (S) 0~255S], press FOCUS+/FOCUS-, left/right to shake the joystick, choose the delay time

2. then, Up / down shake the joystick or press ZOOM+/ZOOM-, so that the cursor is pointing to <TOUR

SET, press FOCUS+ you can see No. 1~16 presets, left/right to shake the joystick, choose NO.1 PRESETS

press IRIS +save, return the menu setting No. 2~16 presets same with before as below picture.

Preset position can be changed by pressing ZOOM+/ZOOM-, press IRIS + saved.

3. then, Up / down shake the joystick or press ZOOM+/ZOOM-, so that the cursor is pointing to < TOUR RUN>.

5.4.3<SCAN SETTINGS>

On the picture <3.4 FUNCTION SETTINGS>, Up / down shake the joystick or press ZOOM+/ZOOM-, so that

the cursor is pointing to <SCAN SETTINGS>, press FOCUS+, enter scan setting menu as below;

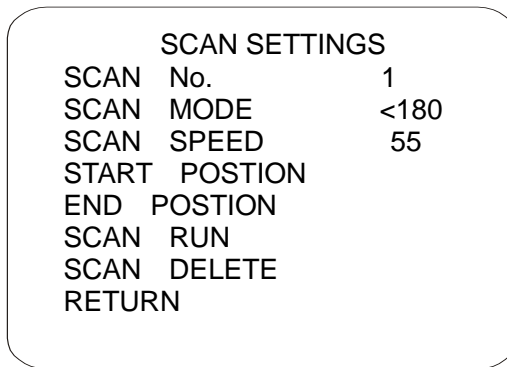

Picture 5.4.3 SCAN SETTINGS

< SCAN SETTINGS > menu is used to set left/right scan.functions as below;

SCAN No.:

SCAN MODE: (>180° or <180°)

SCAN SPEED: :0~63 level

START POSTION:

END POSTION:

SCAN RUN:

SCAN DELETE:

RETURN:

<left/right scan setting> is used to set left/right scan route,operated as below;

1. Choose left/right scanning number;
2. On the picture 3.4.3 <left/right scan menu>, up/down to shake the joystick and press ZOOM+/ZOOM-, make the cursor point to<START POSTION>;
3. Press FOCUS+, enter scan start, shake the joystick to determine left/right scanning end position,
press IRIS+save;
4. Up/down to shake the joystick ZOOM+/ZOOM-, make the cursor point to <END POSTION>;
5. press FOCUS+, enter scanning end,shake the joystick to determine left/right scanning end position,
press IRIS+save;
6. Up/down to shake the joystick , choose<SCAN RUN>, start left/right scanning.

5.4.4<PATTERN SETTINGS>

On the picture 3.1 <FUNCTION SETTINGS>, up/down to shake the joystick,make the cursor point at <PATTERN SETTINGS >, press FOCUS+, enter pattern settings menu as below;

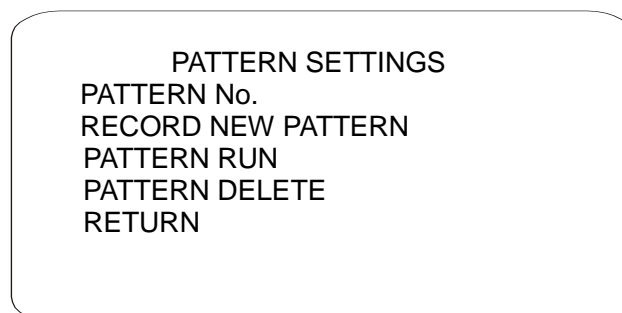

Picture 5.5<PATTERN SETTINGS>

<PATTERN SETTINGS> menu is used to record user defined scan route,function description as below;

PATTERN No.:

RECORD NEW PATTERN:

PATTERN RUN

PATTERN DELETE:

RETURN:

PATTERN SETTINGS

PATTERN No.

RECORD NEW PATTERN

PATTERN RUN

PATTERN DELETE

RETURN

Pattern scanning is used to set and clear the pattern scanning route.

Pattern Scanning Numbers: select the scanning number from 1 to 4. As follow:

1. On the picture 3.5<PATTERN SETTINGS >, up/down to shake the joystick, make the cursor point at

<PATTERN NO.>;

2. up/down to shake the joystick, pressZOOM+/ZOOM-, make the cursor point at < RECORD NEW PATTERN

>FOCUS+; enter record pattern scanning

3. up/down to shake the joystick or press ZOOM+/ZOOM-, record pattern scanning route;

4. up/down to shake the joystick or pressZOOM+/ZOOM-, up/down to shake the joystick or press <

PATTERN RUN >press FOCUS+, run pattern scanning.

5.5 SYSTEM SETTINGS

On the picture 3.1<MAIN MENU> , up/down to shake the joystick or pressZOOM+/ZOOM-, make the cursor point at <SYSTEM SETTINGS>, press FOCUS+, enter 3.6 <SYSTEM SETTINGS> as below.

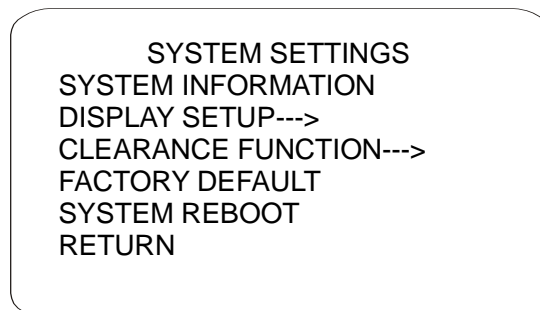

Picture 5.5 SYSTEM SETTINGS

< SYSTEM SETTINGS > menu is used to set the system. Functions description as below;
SYSTEM INFORMATION:

<DISPLAY SETUP>:
<CLEARANCE FUNCTION>:
FACTORY DEFAULT:
SYSTEM REBOOT:
RETURN:

5.5.1 DISPLAY SETTINGS

On the picture 3.6 <SYSTEM SETTINGS>, up/down to shake the joystick,make the cursor point at < DISPLAY SETUP>, press FOCUS+, enter 3.6.1 <DISPLAY SETTINGS>menu, as below;

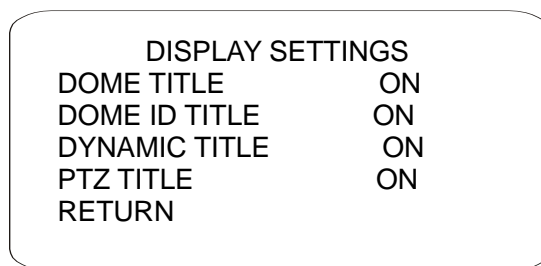

Picture 5.5.1 DISPLAY SETTINGS

<DISPLAY SETTINGS> menu is used to set display setting,function description as below;
DOME TITLE: ON/OFF
DOME ID TITLE: ON/OFF
DYNAMIC TITLE: ON/OFF
PTZ TITLE: ON/OFF
RETURN:

5.6 CLEARANCE SETTINGS:

On the picture 3.6 SYSTEM SETTINGS, up/down to shake the joystick,make the point at < CLEARANCE FUNCTION>, press FOCUS+enter< CLEARANCE SETTINGS> setting, as below;

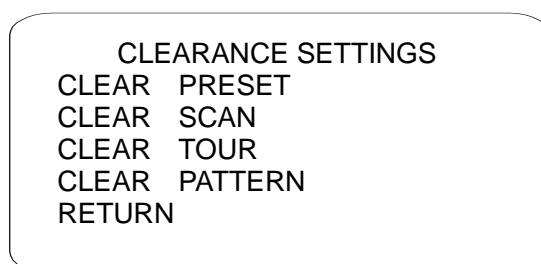

Picture 5.5.2 CLEARANCE SETTINGS

<CLEARANCE SETTINGS> menu is used to set clear function, description as below;
CLEAR PRESET:
CLEAR SCAN:
CLEAR TOUR:

CLEAR PATTERN:
RETURN:

5.7 SPECIAL_FUNC MENU:

On the picture 3.1 MAIN MENU, up/down shake the joystick, make the cursor point at < SPECIAL FUNCTION>, press FOCUS+, enter <SPECIAL_FUNC MENU> as below;

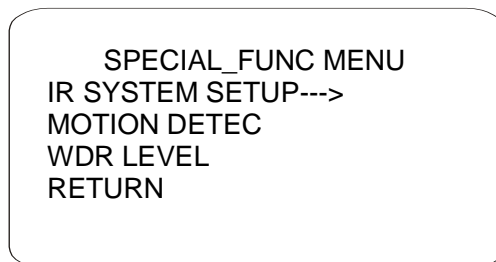

Picture 5.7 SPECIAL_FUNC MENU

<SPECIAL_FUNC MENU> menu is used to set other special function. Functions description as below;

IR SYSTEM SETUP: (Suspense is no such menu settings)

MOTION DETEC: , ON/OFF。

WDR LEVEL: , OF/OFF。

RETURN:

5.7.1 IR SYSTEM SETUP:

On the picture 3.7 <IR SYSTEM SETUP> MENU, up/down shake the joystick, make the cursor point at < IR SYSTEM SETUP>, press FOCUS+, enter 3.7.1 SPECIAL_FUNC MENU as below;

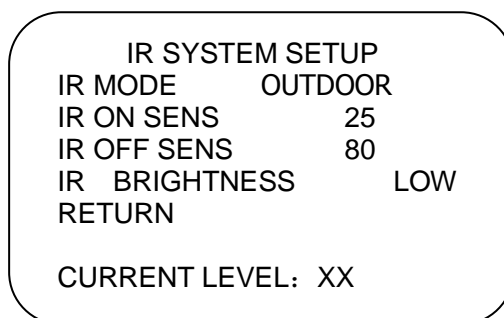

Picture 5.7.1 IR SYSTEM SETUP

< IR SYTEM SETUP > menu is used to set IR system setup. Functions description as below;

IR MODE: Indoor / Outdoor , system default as outdoor mode

IR Outdoor Mode (1 ~ 7 times open IR light , >7 times open the outer ring, inner ring off)

IR Indoor Mode (1 ~ 7 times open inner ring, >7 times open the outer ring)

IR ON SENS: 10~50 acquiesce in 25。

IR OFF SENS: 60~255 acquiesce in 80。

RETURN:

CURRENT LEVEL:

< IR SYTEM SETUP > menu is used to set IR system setup. Concrete operations as follows:

1、 In <IR SYSTEM SETUP> MENU, up/down shake the joystick, make the cursor point at < IR SYSTEM SETUP>, press FOCUS+ or left/right joystick to choose the needed model, then press FOCUS+;

2、 Up / down shake the joystick, make the cursor point at < IR ON SENS>, press FOCUS+ or left/right joystick to choose the parameter.(<IR ON SENS>is adjust according to ISO of installation environment, normal environment based on system default value)

3、 Up / down shake the joystick, make the cursor point at < IR off SENS>, press FOCUS+ or left/right joystick to choose the parameter. (<IR ON SENS>is adjust according to ISO of installation environment, normal environment based on system default value)

Chapter 6 Simple fault clearing form and maintain

6.1 Simple fault clearing and maintain

fault phenomenon	Possible causes	solutions
Electricity without action, no image	connect the wrong power cable	correct
	Power supply is damaged	Replacement
	Protective tube is damaged	Replacement
	Power cable connect not good	Eliminate
Self test and with image after power on but can not control	the IR high speed dome camera address code, baud rate is wrong	re-set the high speed dome camera address code, baud rate
	RS-485 cable connect wrong	Check RS-485 connect cable
The image is unstable	A poor contact for video cables	Eliminate
	Power is not enough	Replacement
Can control but not smooth	RS-485 cable bad contact	Check RS-485 control connections
	One RS-485 cable break	Check RS-485 control connections

6.2 precautions

1. Be careful transport

Transport, storage and installation process to prevent stress, violent vibration and soak for product damage.

2. Don't unauthorized video camera

Don't dismantle the screws or protective cover, inside machine and no user serviceable parts. The related work, shall be conducted by qualified service personnel.

3. Install carefully acrylic

Be careful, handled with care, don't force extrusion machine and various structural components, lest cause ball machine breakdown. To be on the safe side, not installed ball cover do not electrify.

4. Power supply, video line and control

Video line and control the power cord, had better use the shielding wire and independent wiring, cannot be combined with other line JiaoHun together.

5. Electrical safety

Use must abide by various electrical safety standard, the ball machine or signal transmission lines should be with high pressure equipment or cable keep enough distance (at least 50 meters), when necessary even prepare necessary by lightning, surge protection.

6. Cleaning

Cleaning the camera casings, please use dry soft cloth to wipe, if bilge serious when, please use neutral detergent wiped gently. Don't use strong or with non-abrasive cleaner, lest scratches on the outer garment, affects the image quality.

7. Note strictly sealed to prevent liquid from entering the or the eyewinker fall into the ball inside machine equipment, otherwise, it will cause permanent damage.

8. Don't beyond limit temperature, humidity while use the camera.

PTZ dome camera using temperature is from - 25 °C to 70 °C, humidity less than 90%.

9. Don't mount the camera on the air-conditioning outlet.

Under the following circumstances, lens for condensation of water vapor born mist.

by air conditioner when opened, rapid temperature closed caused changes.

off when the rapid temperature changes, When the door is opened by caused.

in can make glasses and fog under the environment of use.

in smoky or dirt room inside and use.

10. Don't long cameras toward strong illuminant, such as the sun.

Spot light can cause screen aging etc. Long time will cameras toward strong illuminant, may be due to the colour on filter CCD image caused damage lose colour.

6.3 after service

Dear users, in order to ensure the full enjoyment of your services, please read the following products and services charter.

(1) we supply the speed dome camera of limited warranty and lifetime maintenance services

1. The warranty period from the date of sale for 12 months, in the warranty period, you will enjoy the product free service, delivered or sent by the user (improper use man-made causes of failure or an irresistible fault do not belong to the scope of the warranty).

2. After 12 month limited free repairing duration, the products will absorb life time repair with payable services.

Product Warranty Cards

Under this product warranty description to repair the goods. Note that every case of normal use the product itself due to quality problems caused by failures in the warranty period will be given free maintenance.

Warranty Description:

1. This product is free of charge warranty period of one year, during the warranty period any product quality problems occur, so doing the warranty card for free (non-human damage), life-long maintenance.

2. Resulted of improper use or other reasons as well as the failure of products outside the warranty period can be so doing card repair, free of maintenance, only charge the component costs.

3. Product required maintenance should be a copy of this card and the invoice with the product delivery of the Company or the local special maintenance department.

4. Open the machine by personal, tearing up letters labeling, we need to charge the components.

5. Do not repair the machine after the modification or installation of other functions to the product.

The following conditions will not be free:

1. Due to normal wear and tear caused by periodic inspection, maintenance, repair or replacement parts.
2. As the fall, extrusion, soaking, damp, and other man-made damage.
3. Because of flood, fire, lightning and other natural disasters or force majeure of the factors that damage.
4. By non-authorized repair centers repair the machine off.
5. Listed above, if changed please follow the related information.

Model No.	
Manufacturing No.	
Delivery date	

Company name	
Contact person	
Company address	
Company tel No.	

Maintenance date	Fault condition	Maintenance sites	Maintenance result

remarks_____
