

INSTRUCTION MANUAL Ver 2.1

MICRO 10x SPEED DOME CAMERA

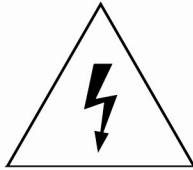

**CAUTION****RISK OF ELECTRIC
SHOCK DO NOT OPEN**

**CAUTION : TO REDUCE THE RISK OF ELECTRICAL SHOCK, DO NOT OPEN COVERS.
NO USER SERVICEABLE PARTS INSIDE.
REFER SERVICING TO QUALIFIED SERVICE PERSONAL.**

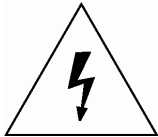

This lightning flash with arrowhead symbol is intended to alert the user to the presence of un-insulated "dangerous voltage" within the product's enclosure that may be of sufficient magnitude to constitute a risk of electric shock to persons.



This exclamation point symbol is intended to alert the user to the presence of important operating and maintenance (servicing) instructions in the literature accompanying the appliance.

**WARNING : TO PREVENT THE RISK OF FIRE OR ELECTRIC SHOCK HAZARD, DO NOT EXPOSE
THIS CAMERA TO RAIN OR MOISTURE.**



Important Safeguard

1. Read Instructions

Read all of the safety and operating instructions before using the product.

2. Retain Instructions

Save these instructions for future reference.

3. Attachments / Accessories

Do not use attachments or accessories unless recommended by the appliance manufacturer as they may cause hazards, damage product and void warranty.

4. Water and Moisture

Do not use this product near water or moisture.

5. Installation

Do not place or mount this product in or on an unstable or improperly supported location. Improperly installed product may fall, causing serious injury to a child or adult, and damage to the product. Use only with a mounting device recommended by the manufacturer, or sold with the product. To insure proper mounting, follow the manufacturer's instructions and use only mounting accessories recommended by manufacturer.

6. Power source

This product should be operated only from the type of power source indicated on the marking label.

Precautions

Operating

- Before using, make sure power supply and others are properly connected.
- While operating, if any abnormal condition or malfunction is observed, stop using the camera immediately and then contact your Special dealer.

Handling

- Do not disassemble or tamper with parts inside the camera.
- Do not drop or subject the camera to shock and vibration as this can damage camera.
- Care must be taken when you clean the clear dome cover. Especially, scratch and dust will ruin your quality of camera.

Installation and Storage

- Do not install the camera in areas of extreme temperature, which exceed the allowable range.
- Avoid installing in humid or dusty places.
- Avoid installing in places where radiation is present.
- Avoid installing in places where there are strong magnetic fields and electric signals.
- Avoid installing in places where the camera would be subject to strong vibrations.
- Never expose the camera to rain and water.



① Introduction	
Features	5
Product & Accessories	7
Parts Name & Functions	8
② Installation	
DIP Switch Setup	9
Direct Installation on the Ceiling	11
Cabling	12
③ Operation	
Checking Before Operation	14
Preset and Pattern Function Pre-Check	14
Start OSD Menu	15
Reserved Preset	15
Preset	16
Scan	16
Pattern	17
Group	18
Schedule	19
Other Functions	20
OSD Display of Main Screen	21
④ How to use OSD Menu	
General Rules of Menu Operation	22
Main Menu	22
Display Setup	23
Privacy Zone Mask Setup	24
Motion Setup	25
Function Setup	27
Preset Setup	28
Scan Setup	30
Pattern Setup	31
Group Setup	32
Schedule Setup	34
Camera Setup	35
System Setup	37
System Initialize	38
⑤ Specifications	
Specifications	39
Dimension	40



Features

□ Camera Specifications

- CCD Sensor : 1/4" Interline Transfer CCD
- Zoom Magnification : × 10 Optical Zoom, × 10 Digital Zoom (Max × 100 Zoom)
- Day & Night Function
- Various Focus Mode: Auto-Focus / Manual Focus / Semi-Auto Focus.
- Independent & Simultaneous Camera Characteristic Setup in Preset operation

□ Powerful Pan/Tilt Functions

- Max. 360°/sec high speed Pan/Tilt Motion
- Using Vector Drive Technology, Pan/Tilt motions are accomplished in a shortest path. As a result, time to target view is reduced dramatically and the video on the monitor is very natural to watch.
- For jog operation using a controller, since ultra slow speed 0.05°/sec can be reached, it is very easy to locate camera to desired target view. Additionally it is easy to move camera to a desired position with zoom-proportional pan/tilt movement.

□ Preset, Pattern, Scan, Group, Privacy Mask, Schedule and More...

- MAX. 127 Presets are assignable and characteristics of each preset can be set up independently, such as White Balance, Auto Exposure, Label and so on.
- Max. 8 set of Scan action can be stored. This enables to move camera repetitively between two preset positions with designated speed.
- Max. 4 of Patterns can be recorded and played back. This enables to move camera to follow any trajectory operated by joystick as closely as possible.
- Max. 8 set of Group action can be stored. This enables to move camera repetitively with combination of Preset or Pattern or Scan. A Group is composed of max. 20 entities of Preset/Pattern/Scans.
- Privacy Masks are assignable, not to intrude on other's privacy. (4 Privacy Zones)
- 7 rules of Schedule can be assigned by day and time. Appropriate actions (such as Home, Preset, Group, Pattern, Scan) can be defined for each rule. Also, it is possible to make rule by Weekday and weekend to simplify the rule.

□ PTZ(Pan/Tilt/Zoom) Control

- With RS-485 communication, max. 255 of cameras can be controlled at the same time.
- Pelco-D or Pelco-P protocol can be selected as a control protocol in the current version of firmware.



❑ OSD(On Screen Display) Menu

- OSD menu is provided to display the status of camera and to configure the functions interactively.
- The information such as Camera ID, Pan/Tilt/Zoom/Direction, Alarm Input & Output, date/time, current temperature and Preset can be displayed on screen.
- Each display item can be turned on or off independently.

❑ Alarm I/O Functions

- 2 alarm sensor Inputs and 1 relay output are available.
- To reject external electric noise and shock perfectly, alarm sensor Input is decoupled with photo coupler.
- The signal range of sensor input is from DC 5.0 to 12.0 volts to adopt various applications.
- If an external sensor is activated, camera can be set to move to the corresponding Preset position.
- Relay output can be assigned to work with a certain preset.

❑ Reserved Presets for Special Purpose

- Most camera characteristics can be set up easily and directly with reserved preset, not entering into OSD menu. For more information, refer to “Reserved Preset” in this manual and “Direct Key Command” Manual.

Product & Accessories

☐ Product & Accessories

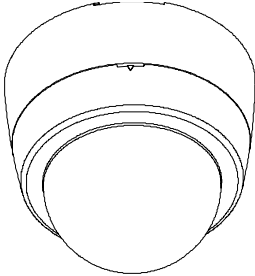

● Main Body

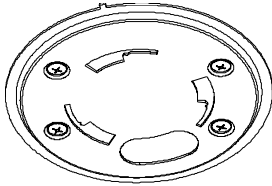

● Surface Mount Bracket

Parts Name & Functions

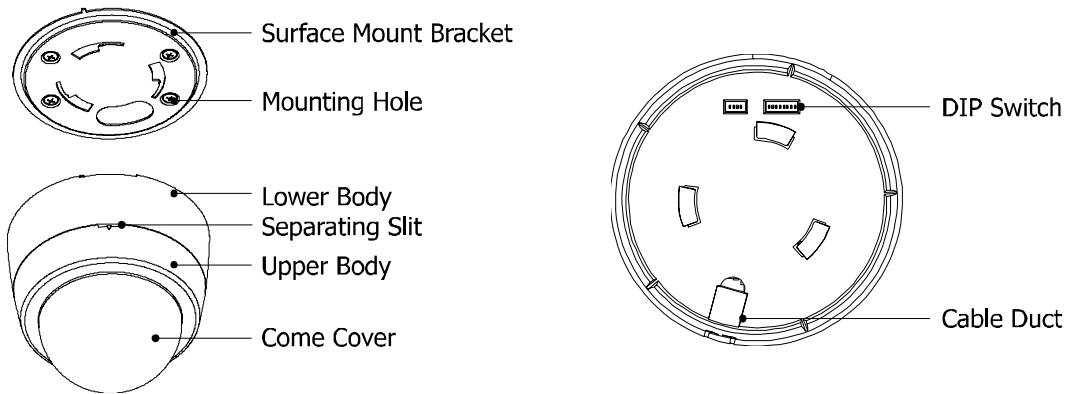

● Main Unit / Surface Mount Bracket

● Back of Main Unit

- Surface Mount Bracket This is used to install the camera directly on the ceiling. After separating this cover first and then attach this directly to ceiling. Camera must be assembled at the last stage.
Do not use this bracket when installing camera on the wall with wall mount bracket or on the ceiling with ceiling mount bracket.
- Separating Slit Using a coin, you can separate upper part lower body of the dome.
- Dome Cover Do not detach protection vinyl from dome cover before finishing all installation process to protect dome cover from scratches or dust.
- DIP Switch Adjusts camera ID and protocols.
- Cable Duct When you want to install the camera on the surface of hard ceiling, you need to handle the cable through side of the dome. In this case, break the side wall bit and make the cable pass through the cable duct.

DIP Switch Setup

Before you install the camera, you should set the DIP switches to configure the camera ID, communication protocol.

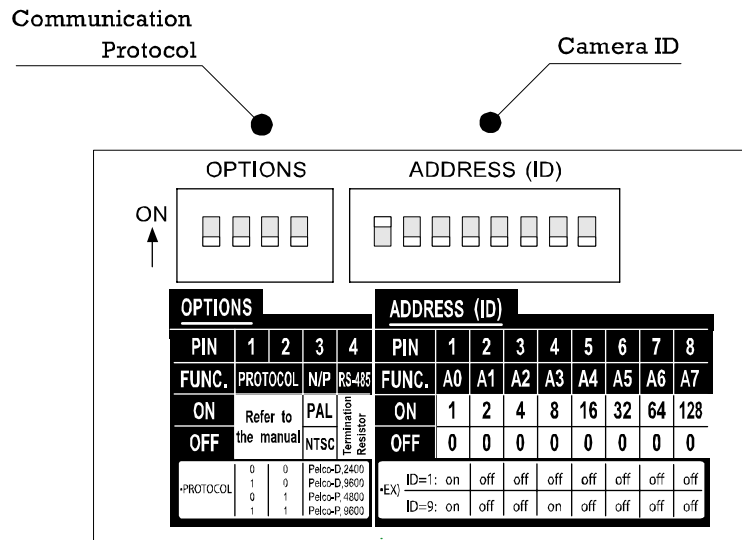

Camera ID Setup

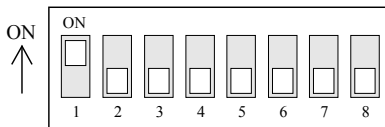

- ID number of camera is set using binary number. The example is shown below.

Pin	1	2	3	4	5	6	7	8
ID Value	1	2	4	8	16	32	64	128
ex) ID=5	on	off	on	off	off	off	off	off
ex) ID=10	off	on	off	on	off	off	off	off

- The range of ID is 1~255. **Do not use 0 as camera ID.** Factory default of Camera ID is 1.
- If you want to control a certain camera, you must match the camera ID with Cam ID setting of DVR or Controller.

❑ Communication Protocol Setup

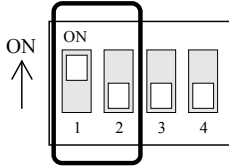

- Select the appropriate Protocol with DIP switch combination.

Switch State		Protocol
P0 (Pin 1)	P1 (Pin 2)	
OFF	OFF	PELCO-D, 2400 bps
ON	OFF	PELCO-D, 9600 bps
OFF	ON	PELCO-P, 4800 bps
ON	ON	PELCO-P, 9600 bps

- If you want to control using DVR or P/T controller, their protocol must be identical to camera. Otherwise, you can not control the camera.
- If you changed camera protocol by changing DIP S/W, the change will be effective after you reboot the camera.
- Factory default of protocol is “Pelco-D, 2400 bps”.

❑ Reserved for Supplier

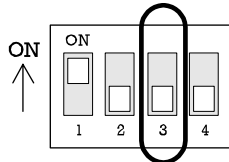

- Since Pin 3 is only for supplier, DO NOT CHANGE THESE ITS ORIGINAL STATE. If you change one of these, proper operation can not be achieved.

⊙ Pin 3 PAL / NTSC system selection of Camera. DO NOT CHANGE THIS PIN.

❑ RS-485 Termination Resistor

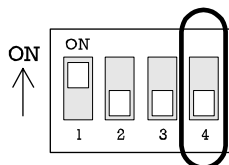

- Pin 4 is used for ON/OFF of RS-485 Termination. Normally, it must be OFF state. Especially when you have trouble with long Daisy chain style connection, turn ON this termination switch of last camera.

⊙ Pin 4 RS-485 Termination Resistor (On/Off)

Installation using Surface mount on the Ceiling

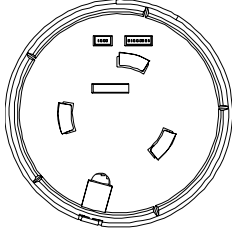
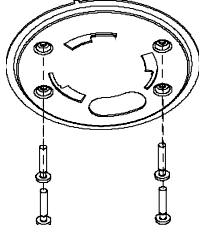
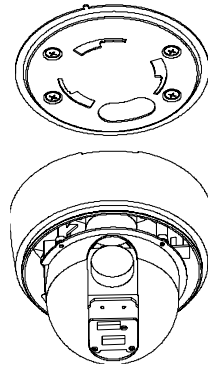
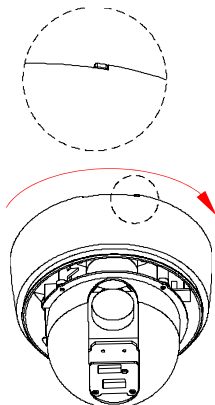
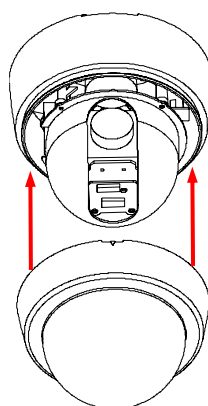
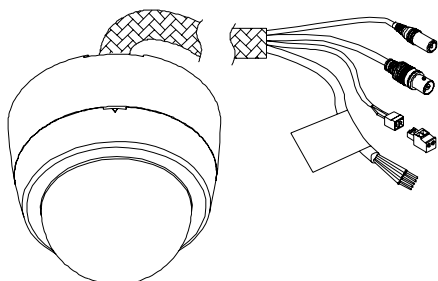
<p>① Setup DIP Switch (see previous page).</p> 	<p>② Screw surface mount bracket to ceiling with 4 screws.</p> 
<p>③ Placing lower body to Surface Mount bracket. The cable must be properly handled into hole of bracket or side of lower body.</p> 	<p>④ Make sure stopper pin of bracket pin is located the rightmost side of lower body groove as shown in the picture. Press the dome and turn clockwise till the pin is located leftmost side of groove.</p> 
<p>⑤ By pressing upper to lower body, assemble the dome. Detach protection vinyl from dome cover.</p> 	<p>⑤ Connect Video, communication, power cable properly. (see next section)</p> 

Cabling

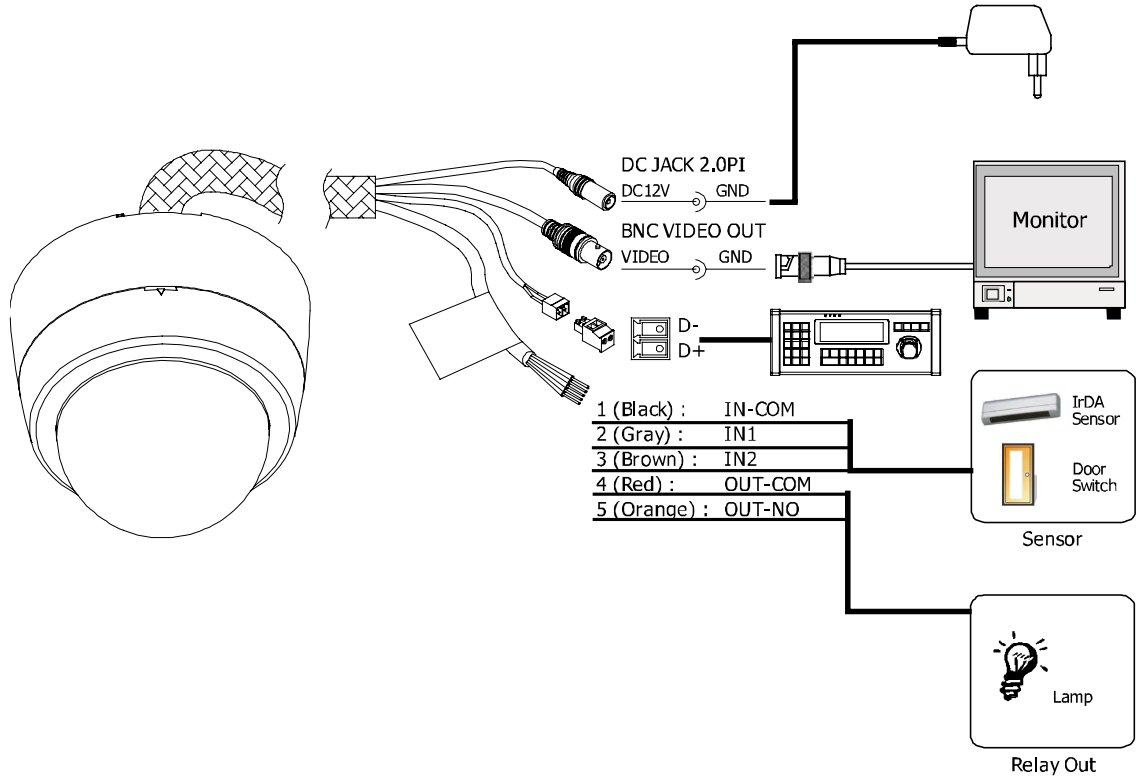

Power Connection

- Please, check the voltage and current capacity of rated power carefully. Rated power is indicated in the back of main unit.

Rated Power	Input Voltage Range	Current Consumption
DC 12V	DC 11V ~ 18V	0.8 A

RS-485 Communication

- For PTZ control, connect this line to keyboard and DVR. To control multiple cameras at the same time, RS-485 communication lines of them is connected in parallel as shown below.

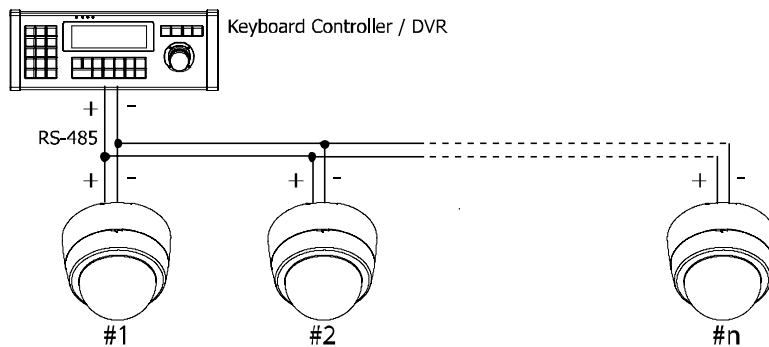

❑ Video Connection

- Connect with BNC coaxial cable.

❑ Alarm Input Connection

- Sensor Input

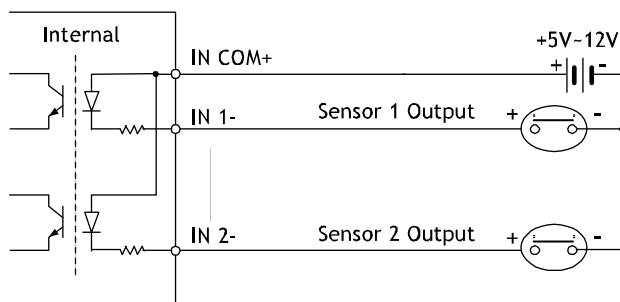

Before connecting sensors, check driving voltage and output signal type of the sensor. Since output signal types of the sensors are divided into Open Collector and Voltage Output type in general, the cabling must be done properly after considering these typed.

Signal	Description
IN COM+	Connect (+) cable of electric power source for Sensors to this port as shown in the circuit above.
IN1-, IN2-	Connect output of sensors for each port as shown in the circuit above.

If you want to use Alarm Input, the types of sensor must be selected in OSD menu. The sensor types are Normal Open and Normal. If sensor type is not selected properly, the alarm can be activated reversely.

⊙ Normal Open	Output Voltage is high state when sensor is activated
⊙ Normal Close	Output Voltage is high state when sensor is not activated

- Relay Output

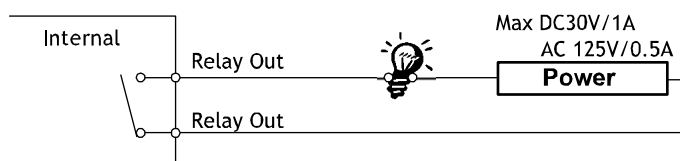

Check points before operation

- Before power is applied, please check the cables carefully.
- The camera ID of the controller must be identical to that of the target camera. The camera ID can be checked by reading DIP switch of the camera.
- If your controller supports multi-protocols, the protocol must be changed to match to that of the camera.
- If you changed camera protocol by changing DIP switch, the change will be effective after you reboot the camera.
- Since the operation method can be different for each controller available, refer to the manual for your controller if camera can not be controlled properly. The operation of this manual is based on the standard Pelco® Controller.

Preset and Pattern Function Pre-Check

- Check how to operate preset and pattern function with controller or DVR in advance to operate camera function fully when using controller or DVR.
- Refer to the following table when using standard Pelco® protocol controller.

< Go Preset >	Input [Preset Number] and press [Preset] button shortly.
< Set Preset >	Input [Preset Number] and press [Preset] button for more than 2 seconds.
< Run Pattern >	Input [Pattern Number] and press [Pattern] button shortly.
< Set Pattern >	Input [Pattern Number] and press [Pattern] button for more than 2 seconds.

- If controller or DVR has no pattern button or function, use shortcut keys with preset numbers. For more information, refer to “Reserved Preset” in this manual.

Starting OSD Menu

- **Function** Using the OSD menu, Preset, Pattern, Scan, Group and Alarm Input function can be configured for each application.
- **Enter Menu** <Go Preset> [95]

Reserved Preset

- **Description** Some Preset numbers are reserved to special functions.
- **Function**
 - <Go Preset> [95] : Enters into OSD menu
 - <Go Preset> [131~134] : Runs Pattern Function 1 ~ 4
 - <Go Preset> [141~148] : Runs Scan Function 1 ~ 8
 - <Go Preset> [151~158] : Runs Group Function 1 ~ 8
 - <Go Preset> [161~162] : Sets Relay Output 1 ~ 2 to OFF
 - <Set Preset> [161~162] : Sets Relay Output 1 ~ 2 to ON
 - <Go Preset> [170] : Sets Camera BLC Mode to OFF
 - <Go Preset> [171] : Sets Camera BLC Mode to ON
 - <Go Preset> [174] : Sets Camera Focus Mode to AUTO
 - <Go Preset> [175] : Sets Camera Focus Mode to Manual
 - <Go Preset> [176] : Sets Camera Focus Mode to SEMI-AUTO
 - <Go Preset> [177] : Sets Day & Night Mode to AUTO
 - <Go Preset> [178] : Sets Day & Night Mode to NIGHT
 - <Go Preset> [179] : Sets Day & Night Mode to DAY
 - <Go Preset> [190] : Sets OSD Display Mode to AUTO (Except Privacy Mask)
 - <Go Preset> [191] : Sets OSD Display Mode to OFF (Except Privacy Mask)
 - <Go Preset> [192] : Setting OSD Display Mode to ON (Except Privacy Mask)
 - <Go Preset> [193] : Sets all Privacy Mask Display to OFF
 - <Go Preset> [194] : Sets all Privacy Mask Display to ON
 - <Go Preset> [167] : Zoom Proportional Jog ON
 - <Set Preset>[167] : Zoom Proportional Jog OFF

Note: For more additional direct commands, refer Direct Key Command Manual.



Preset

- **Function** Max. 127 positions can be stored as Preset position. The Preset number can be assigned from 1 to 128, but 95 is reserved for starting OSD menu.
Camera characteristics (i.e. White Balance, Auto Exposure) can be set up independently for each preset. Label should be blank and "Camera Adjust" should be set to "GENERAL" as default. All characteristics can be set up in OSD menu. One relay output can be reacted by
- **Set Preset** <Set Preset> [1~128]
- **Run Preset** <Go Preset> [1~128]
- **Delete Preset** To delete Preset, use OSD menu.

Scan

- **Function** By using Scan function, you can make camera to move between 2 Preset positions repeatedly. When Scan function runs, camera moves from the preset assigned as the 1st point to the preset assigned as the 2nd point in CW(Clockwise) direction. Then camera moves from the preset assigned as the 2nd point to the preset assigned as the 1st point in CCW(Counterclockwise) direction.

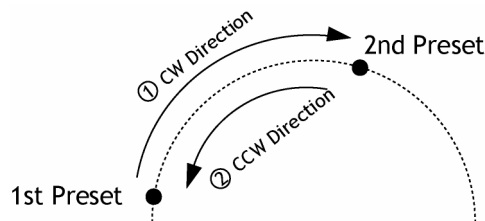

In case that the preset assigned as the 1st point is same as the preset assigned as the 2nd point, camera turns on its axis by 360° in CW(Clockwise) direction and then it turns on its axis by 360° in CCW(Counterclockwise) direction.

Speed can be set up from 1°/sec to 180°/sec.

- **Set Scan** To set Scan, use OSD menu.
- **Run Scan** Method1) <Run Pattern> [Scan NO.+10] ex) Run Scan 3 : <Run Pattern> [13]
Method2) <Go Preset> [Scan NO.+140] ex) Run Scan 3 : <Go Preset> [143]
- **Delete Scan** To delete Scan, use OSD menu.



Pattern

- **Function** Pattern Function is that a camera memorizes the path (mostly curve path) by joystick of controller for assigned time and revives the path exactly as it memorized.
4 Patterns are available and Maximum 1200 communication commands can be stored in a pattern.

- **Set Pattern** Pattern can be created by one of following two methods.

Method 1) <Set Pattern> [Pattern NO.]

- Pattern editing screen is displayed as bellow.

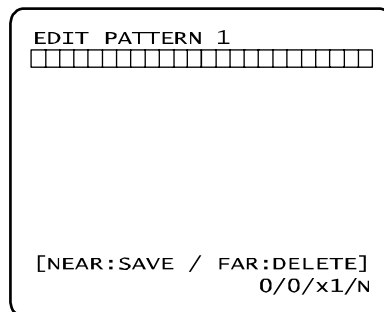

- Movement by Joystick and preset movement can be memorized in a pattern.
- The rest memory size is displayed in progress bar.
- To save the recording, press **NEAR** key and to cancel, press **FAR** key.

Method 2) OSD Using OSD Menu: See the section "How to use OSD Menu".

- **Run Pattern** Method 1) <Run Pattern> [Pattern NO.] ex) Run Pattern 2 : <Run Pattern> [2]
Method 2) <Go Preset> [Pattern NO.+130] ex) Run Pattern 2: <Go Preset> [132]
- **Delete Pattern** Use OSD menu to delete a Pattern.

Group

- **Function** The group function allows running sequence of Presets, Pattern and/or Scans. Max 8 group can be stored. Each group can have max 20 action entities which can be preset, pattern or scan. Preset speed can be set up and the repeat number of Pattern & Scan can be set up in Group setup. Dwell time between actions can be set up also.

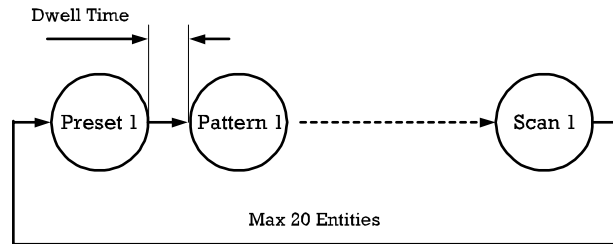

- **Set Group** Use OSD Menu to create a Group.
- **Run Group**

Method1) <Run Pattern> [Group NO.] Run Group 7 : <Run Pattern> [27]
NO.+20]

Method2) <Go Preset> [Group NO.+150] ex) Run Group 7 : <Go Preset> [157]
- **Delete Group** Use OSD Menu to delete.



Schedule

- **Function** The Schedule function allows running an appropriate function like Preset, Scan, Group, Pattern, Home move at designated day and time. For example, if you setup a rule Tuesday at 9:00AM and Preset 1 (say Main Gate), the camera will move to main gate every Tuesday at 9:00AM. If you choose Weekday, camera will move to Main gate everyday except weekend.

It is noted that due to the real time clock, the time data will be kept regardless of blackout. The initial time and day setup is essential to proper Schedule function.
- **Set Schedule** Use OSD Menu to create a Schedule
- **Run Schedule** Use OSD Menu of Schedule Master Enable
- **Delete Schedule** Use OSD Menu to delete.



Other Functions

- **Power Up Action** This function enables to resume the last action executed before power down. Most of actions such as Preset, Pattern, Scan and Group are available for this function but Jog actions are not available to resume.
- **Auto Flip** If tilt angle exceeds -90° , Pan is automatically turned to opposite direction ($+180^\circ$) to track the target continuously. If this function is set to OFF, tilt movement range is $0 \sim 95^\circ$.
- **Parking Action** This function enables to locate the camera to specific position automatically if operator doesn't operate the controller for a while. The Park Time can be defined as an interval from 1 minute to 4 hours.
- **Alarm Input** 2 Alarm Inputs are used. If an external sensor is activated, camera can be set to move to corresponding preset position. It is noted that the latest alarm input is effective if multiple sensors are activated.
- **Privacy Zone Mask** To protect privacy, MAX. 4 Privacy Masks can be created on the arbitrary position to hide objects such as windows, shops or private house. With Spherical Coordinates system, powerful Privacy Zone Mask function is possible.
- **GENERAL/SPECIAL Image Setup** WB(White Balance) and AE(Auto Exposure) can be set up independently for each preset. There are 2 modes, "General" mode & "Special" mode. The General mode means that WB or AE can be set up totally and simultaneously for all presets in "ZOOM CAMERA SETUP" menu. The Special mode means that WB or AE can be set up independently or separately for each preset in each preset setup menu. Each Special WB/AE value should activate correspondingly when camera arrives at each preset location.
During jog operation, General WB/AE value should be applied. All Special WB/AE value will not be changed although General WB/AE value change.
- **Semi Auto Focus** This mode exchanges focus mode automatically between Manual Focus mode and Auto Focus mode by operation. Manual Focus mode activates in preset operation and Auto Focus mode activates during jog operation. With Manual mode at presets, Focus data is memorized in each preset in advance and camera calls focus data in correspondence with presets as soon as camera arrives at a preset. It should shorten time to get focuses.
Focus mode changes to Auto Focus mode automatically when jog operation starts.

OSD Display of Main Screen

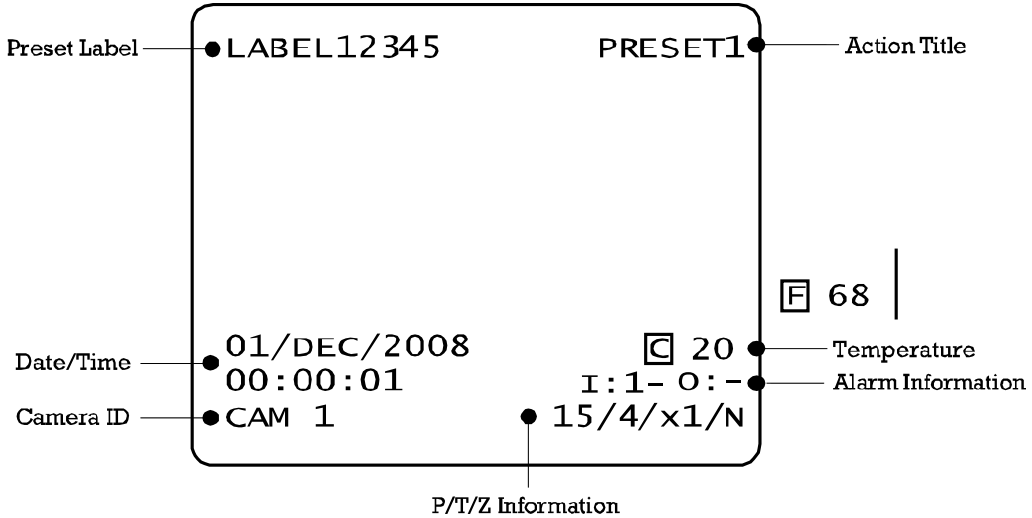

- P/T/Z Information Current Pan/Tilt angle in degree, zoom magnification and a compass direction.
- Camera ID Current Camera ID(Address).
- Action Title Followings are possible Action Titles and their meaning.

"SET PRESET xxx"	When Preset xxx is stored
"PRESET xxx"	When camera reach to Preset xxx
"PATTERN x"	When Pattern x is in action
"SCNx/PRESET xxx"	When Scan x is in action
"UNDEFINED"	When undefined function is called to run
- Preset Label The Label stored for specific Preset.
- Alarm Information This information shows current state of Alarm Input. The "I" means Input and "D" is output. If an Input is **ON** state it will show the number of input. If an Input is **OFF** state, '-' will be displayed. In the same way "D:1" means output 1 is ON "D:-" is OFF.

Ex) When Point 2 of inputs are **ON**, and Output 1 is On, OSD will show as below

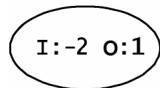

- Temperature Current Temperature: Boxed "C" and "F" means Celsius and Fahrenheit respectively
- Date/Time Displays Current Date and Time.

General Rules of Key Operation for Menu

- The menu items surrounded with () always has its sub menu.
- For all menu level, to go into sub menu, press **NEAR** key.
- To go to up-one-level menu, press **FAR** key.
- To move from items to item in the menu, use joystick in the **Up/Down** or **Left/Right**.
- To change a value of an item, use **Up/Down** of the joystick in the controller.
- Press **NEAR** key to save values and Press **FAR** key to cancel values.

Main Menu

```

ROOT MENU
-----
-><SYSTEM INFORMATION>
<DISPLAY SETUP>
<MOTION SETUP>
<FUNCTION SETUP>
<CAMERA SETUP>
<SYSTEM SETUP>
<SYSTEM INITIALIZE>

EXIT

```

- System Information Shows info and current configuration.
- Display Setup Enable/Disable of OSD display on Main Screen.
- Motion Setup Setup for motion related settings
- Function Setup Setup for various functions such as Preset, Scan, Pattern, Group and Schedule.
- Camera Setup Configure Camera related functions and data
- System Setup Configure for Basic system setup.
- System Initialize Initializes system configuration and sets all data to factory default configuration.

Display Setup

```

DISPLAY SETUP
-----
->CAMERA ID          ON
PTZ INFORMATION     AUTO
ACTION TITLE        AUTO
PRESET LABEL        AUTO
ALARM I/O           AUTO
DATE/TIME           ON
TEMPERATURE         CELSIUS
<SET NORTH DIRECTION>
<PRIVACY ZONE>
BACK
    
```

This menu defines Enable/Disable of OSD display on Main Screen. If an item is set to be AUTO, the item is displayed only when the value of it is changed.

- Camera ID [ON/OFF]
- PTZ Information [ON/OFF/AUTO]
- Action Title [ON/OFF/AUTO]
- Preset Label [ON/OFF/AUTO]
- Alarm Input [ON/OFF/AUTO]
- Date/Time [ON/OFF]
- Temperature [CELSIUS/FAHRENHEIT/OFF]

☐ Compass Direction Setup

```

SET NORTH DIRECTION
-----

MOVE TO TARGET POSITION
[NEAR:SAVE / FAR:CANCEL]
0/0/x1/N
    
```

Set North to assign compass direction as criteria. Move camera and press **NEAR** button to save.

Privacy Zone Mask Setup

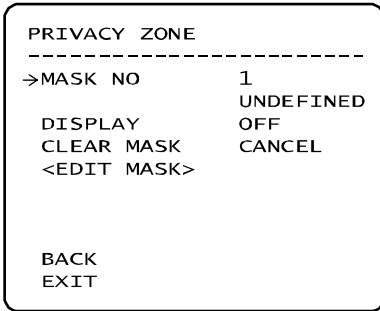

Select area in image to mask.

- Mask No [1~4]
Select Mask number. If the selected mask has already data, camera moves as it was set. Otherwise, "UNDEFINED" will be displayed under "Mask NO".
- Display [ON/OFF]
Sets if camera makes mask shows or not on images.
- Clear Mask [CANCEL/OK]
Deletes data in the selected mask NO.

□ Privacy Zone Area Setup

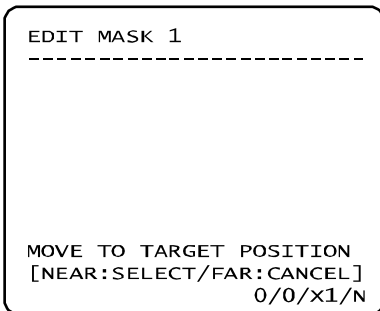

Move camera to area to mask. Then the menu to adjust mask size will be displayed.

□ Privacy Zone Size Adjustment

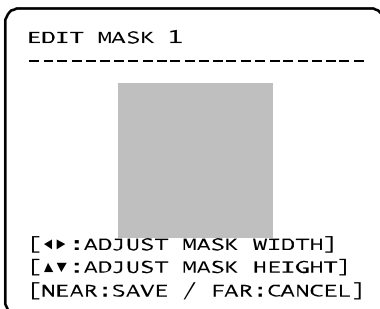

Adjust mask size. Use joystick or arrow buttons to adjust mask size.

- ◀ ▶ (Left/Right) Adjusts mask width.
- ▲ ▼ (Up/Down) Adjusts mask height.

Motion Setup

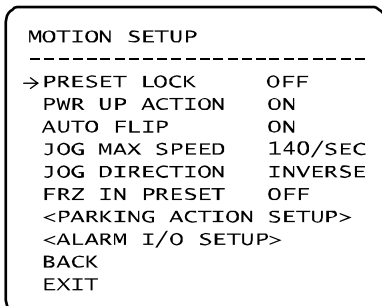

Setup the general functions of Pan/Tilt motions.

- Preset Lock [ON/OFF]

If Motion Lock is set to ON, it is impossible to set up and delete Preset, Scan, Pattern and Group. It is possible only to run those functions. To set up and delete those functions, enter into OSD menu.
- Power Up Action [ON/OFF]

Refer to "Other Functions" section.
- Auto Flip [ON/OFF]

Refer to "Other Functions" section.
- Jog Max Speed [1°/sec ~360°/sec]

Sets maximum jog speed. Jog speed is inversely proportional to zoom magnification. As zoom magnification goes up, pan/tilt speed goes down.
- Jog Direction [INVERSE/NORMAL]

If you set this to 'Inverse', the view in the screen is moving same direction with jog tilting. If 'Normal' is selected, the view in the screen is moving reversely.
- Freeze in Preset [ON/OFF]

At start point of preset movement, camera starts freezing the image of start point. Camera keeps displaying the image of start point during preset movement and does not display the images which camera gets during preset movement. As soon as camera stops at preset end point, camera starts displaying live images which it gets at preset end point.

This function availability should be different by models.

❑ Parking Action Setup

```

PARKING ACTION SETUP
-----
->PARK ENABLE    OFF
   WAIT TIME    00:10:00
   PARK ACTION   HOME

BACK
EXIT
    
```

If Park Enable is set to ON, camera runs assigned function automatically if there is no PTZ command during assigned "Wait Time".

- Park Enable [ON/OFF]
- Wait Time [1 minute ~ 4 hour]
The time is displayed with "hh:mm:ss" format and you can change this by 1 min unit.
- Park Action [HOME/PRESET/PATTERN/SCAN/GROUP]
Ex) If HOME is selected for Park Action, camera will move to home position when there is no PTZ command during assigned "Wait Time."

❑ Alarm Input Setup

```

ALARM INPUT SETUP
-----
->ALARM1 TYPE    N.OPEN
   ALARM2 TYPE    N.OPEN
   ALARM1 ACT     NOT USED
   ALARM2 ACT     NOT USED

BACK
EXIT
    
```

Match the Alarm sensor input to one of Preset positions. If an external sensor is activated, camera will move to corresponding preset position when this item is predefined.

- Alarm × Type [Normal OPEN/Normal CLOSE]
Sets sensor input type.
- Alarm × Action [NOT USED/PRESET 1~128]
Assign counteraction Preset position to each Alarm input.

Function Setup

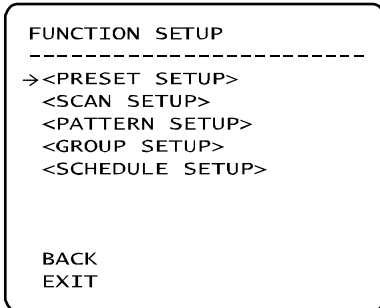

Configure 5 Special Functions with this menu

- **Preset Setup** 127 Presets from the number 1 to 128 can be assigned excluding preset 95 reserved for Menu.

- **Scan Setup** Up to 8 Scans are available, which makes camera to move slowly between two preset points.

- **Pattern Setup** Up to 4 patterns can be stored in the dome. In this function, path data created by manual move of Joystick are recorded and you can playback the identical path automatically whenever required.

- **Group Setup** Up to 8 Group can be defined. In a Group, max 20 entities are assigned from any combinations of Preset/Scan/Pattern. If you run the group, camera will execute each entry sequentially.

- **Schedule Setup** 7 rules of Schedule can be assigned by day and time. Appropriate actions (such as Home, Preset, Group, Pattern, Scan) can be defined for each rule. Also, it is possible to make rule by Weekday and weekend to simplify the rule making.

PRESET Setup

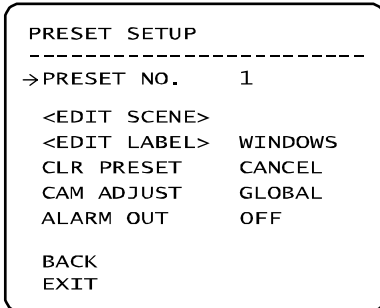

- Preset Number [1~128]
If a selected preset is already defined, camera moves to pre-defined position and preset characteristics such as Label and Relay Outputs show on monitor. If a selected preset is not defined, "UNDEFINED" shows on monitor.
- Edit Preset Scene Redefine current Preset scene position (i.e. PTZ).
- Edit Preset Label Edits Label to show on monitor when preset runs. MAX. 10 alphabets are allowed.
- Clear Preset [CANCEL/OK]
Delete current Preset data
- CAM Adjust [GENERAL/SPECIAL]
WB(White Balance) and AE(Auto Exposure) can be set up independently for each preset. There are 2 modes, "General" mode & "Special" mode. The General mode means that WB or AE can be set up totally and simultaneously for all presets in "ZOOM CAMERA SETUP" menu.
The Special mode means that WB or AE can be set up independently or separately for each preset in each preset setup menu. Each Special WB/AE value should activate correspondingly when camera arrives at each preset location. During jog operation, General WB/AE value should be applied.
All Special WB/AE value should not change although General WB/AE value changes. If "Special" is selected, Menu to set WB/AE shows on monitor.
- Alarm out Relay Output can be linked with Preset run.
Ex) If it is turned to ON, Output 1 relay will be ON whenever you call this Preset.

❑ Edit Preset Scene

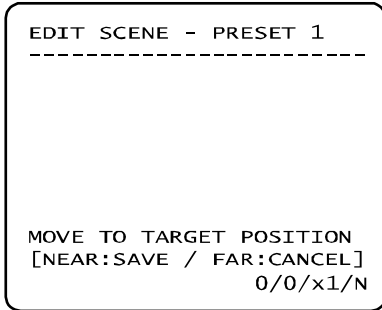

- ① Using Joystick, move camera to desired position.
- ② By pressing **NEAR** key, save current PTZ data.
- ③ Press **FAR** key to cancel.

❑ Edit Preset Label

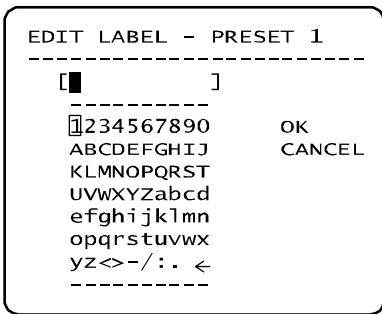

- ① Edits label to show on monitor when camera arrives at presets. In Edit Label menu, a reverse rectangular is cursor. As soon as finishing selecting alphabet, cursor moves to the next digit.

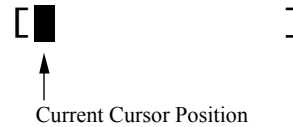

- ② Using **Left/Right/Up/Down** of joystick, move to an appropriate character from the Character set. To choose that character, press the **NEAR** key.

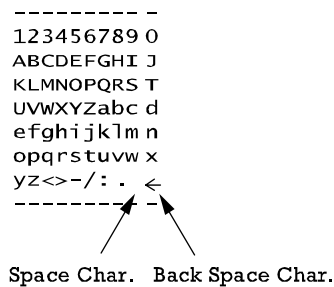

If you want to use blank, choose Space character (" "). If you want to delete a character before, use back space character ("←").

- ③ If you complete the Label editing, move cursor to "OK" and press **NEAR** key to save completed label. To abort current change, move cursor to "Cancel" and press **NEAR** key.

Scan Setup

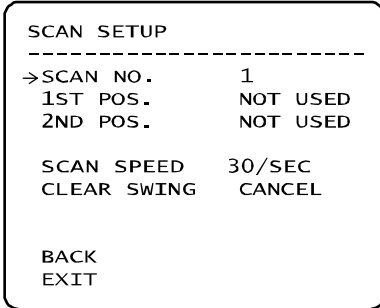

● Scan Number [1~8]
 Selects Scan number to edit. If a selected Scan has not defined, "NOT USED" is displayed in 1st Position and 2nd Position

● 1st Position [PRESET 1~128]
 2nd Position Set up the 2 position for Scan function. If a selected preset is not defined, "UNDEFINED" will be displayed as shown below.

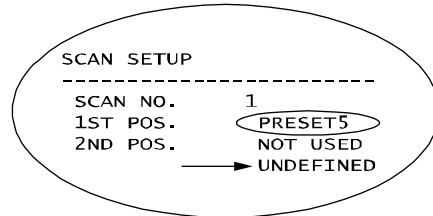

When scan function runs, camera moves from the preset assigned as the 1st point to the preset assigned as the 2nd point in CW(Clockwise) direction. Then camera moves from the preset assigned as the 2nd point to the preset assigned as the 1st point in CCW(Counterclockwise) direction. In case that the preset assigned as the 1st point is same as the preset assigned as the 2nd point, camera turns on its axis by 360° in CW direction and then it turns on its axis by 360° in CCW direction.

● Scan Speed [1°/sec ~180°/sec]
 Sets Scan speed from 1°/sec to 180°/sec.

● Clear Scan [CANCEL/OK]
 Deletes current Scan data.



Pattern Setup

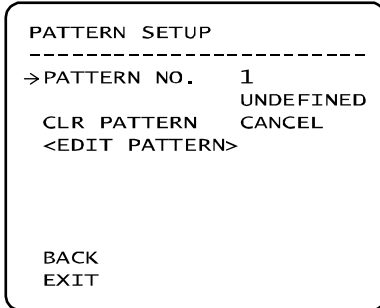

- Pattern Number [1~4]
Selects Pattern number to edit.
If a selected pattern number is not defined, "UNDEFINED" will be displayed under selected pattern number.
- Clear Pattern [CANCEL/OK]
Deletes data in current pattern
- Edit Pattern Starts editing pattern.

□ Edit Pattern

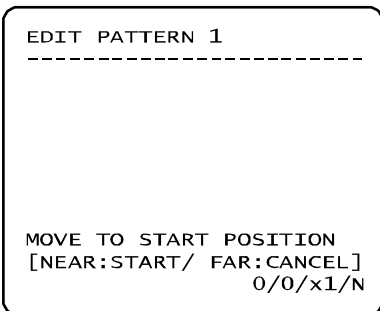

① By using Joystick, move to start position with appropriate zoom. To start pattern recording, press **NEAR** key. To exit this menu, press **FAR** key.

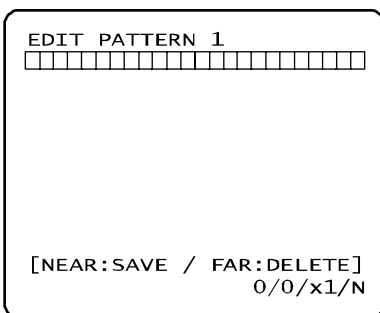

② Move camera with joystick of controller or run preset function to memorize the path (mostly curve path) in a selected pattern. The total memory size and the rest memory size is displayed in the form of bar. Maximum 1200 communication commands can be stored in a pattern.

③ To save data and exit, press **NEAR** key. To cancel recording and delete record data, press **FAR** key.

Group Setup

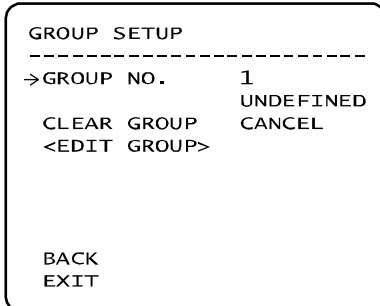

- Group Number [1~8]
Selects Group number to edit.
If a selected Group number is not defined, "UNDEFINED" will be displayed under selected Group number.

- Clear Group [CANCEL/OK]
Deletes data in current Group

- Edit Group Starts editing Group.

□ Edit Group

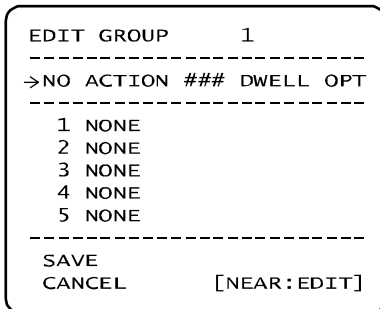

- ① Press **Near** key in "NO" list to start Group setup.

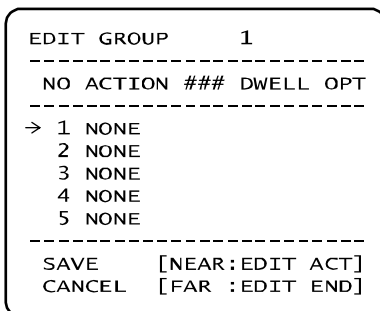

- ② Note that MAX. 20 Functions are allowed in a Group. Move cursor up/down and press **Near** key to set up.

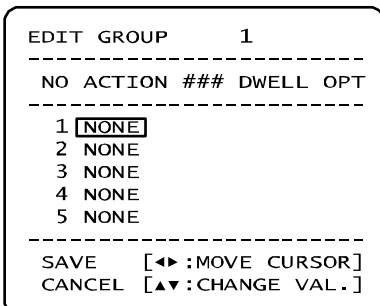

- ③ Set up Action, Dwell time and Option. Note that selected item is displayed in reverse. Move cursor **Left/Right** to select items and move cursor **Up/Down** to change each value.

- Action ### [NONE/PRESET/SCAN/PATTERN]

- DWELL [0 second ~ 4 minutes]

Sets Dwell Time between functions

- OPT Option. It should be preset speed when preset is set in Action. It should be the number of repeat when Pattern or Scan is selected in Action

```

EDIT GROUP      1
-----
NO ACTION ### DWELL OPT
-----
 1 PRESET  [1] 00:03 360
 2 NONE
 3 NONE
 4 NONE
 5 NONE
-----
SAVE  [◀▶:MOVE CURSOR]
CANCEL [▲▼:CHANGE VAL.]
    
```

- ④ Set up items such as Action, ###, Dwell and OPT.

```

EDIT GROUP      1
-----
NO ACTION ### DWELL OPT
-----
-> 1 PRESET  1 00:03 360
 2 NONE
 3 NONE
 4 NONE
 5 NONE
-----
SAVE  [NEAR:EDIT ACT]
CANCEL [FAR :EDIT END]
    
```

- ⑤ After finishing setting up an Action, press **Near** key to one-upper-level menu (Step ②). Move cursor **Up/Down** to select Action number and repeat Step ② ~ Step ④ to edit selected Group.

```

EDIT GROUP      1
-----
NO ACTION ### DWELL OPT
-----
 1 PRESET  1 00:03 360
 2 NONE
 3 NONE
 4 NONE
 5 NONE
-----
->SAVE
CANCEL
    
```

- ⑥ After finishing setting up all Actions, press **FAR** key to exit. Then cursor should be moved to "SAVE." Press **Near** key to save data.

Schedule Setup

```

SCHEDULE SETUP
-----
MASTER ENABLE      ON
  DAY TIME  ACT No
->1 UNDEFINED
  2 UNDEFINED
  3 UNDEFINED
  4 UNDEFINED
  5 UNDEFINED
  6 UNDEFINED
  7 UNDEFINED
  BACK
    
```

- Master Enable [ON/OFF]

Decide whether Schedule function is active or not.
- Clear Group [CANCEL/OK]

Delete all data in current Menu
- Edit Group

Start editing Group.

□ Edit Schedule

```

SCHEDULE SETUP
-----
MASTER ENABLE      ON
  DAY TIME  ACT No
->1 UNDEFINED
  2 UNDEFINED
  3 UNDEFINED
  4 UNDEFINED
  5 UNDEFINED
  6 UNDEFINED
  7 UNDEFINED
  BACK
    
```

④ After move the Cursor to the number by using **Up/Down keys**, press "Near"(Enter) Key to edit.

⑤ Each field can be selected by **Left/Right** keys and the values in the field are changed using **Up/Down** keys.

The meaning of each value:

DAY Days: MON > TUE > WED> THU > FRI > SAT > SUN

WKD: Weekday

ALL: All days(Everyday)

TIME 24hour Format

ACT PRS(Preset), SCN(Scan), PTN(Pattern),GRP(Group)

HOM(Home)

ON/OFF Decide to make this rule effective or not

If you finish a rule, press **Near** key to select another rule.

Repeat this procedure to fill up the schedule in mind.

```

SCHEDULE SETUP
-----
MASTER ENABLE      ON
  DAY TIME  ACT No
->1 MON 00:00 HOME OFF
  2 UNDEFINED
  3 UNDEFINED
  4 UNDEFINED
  5 UNDEFINED
  6 UNDEFINED
  7 UNDEFINED
  BACK
    
```

⑥ Example: see left setup.

- The second rule means camera will move to Preset 12 position at 7:35 on every Wednesday.

* Note: If there are rules conflicts to each other, the higher number is, the higher priority has.

* Note: If you assign undefined function, there will be no action.

* Hint: Using reserved Preset, you can make various schedules. For example, PRS179 are PRS178 are Day and Night mode respectively.

```

SCHEDULE SETUP
-----
MASTER ENABLE      ON
  DAY TIME  ACT No
->1 MON 01:20 HOM ON
  2 WEN 07:35 PRS 12 ON
  3 THU 11:40 SCN 3 ON
  4 SAT 15:17 PAT 1 ON
  5 WEK 23:00 HOM ON
  6 UNDEFINED
  7 UNDEFINED
  BACK
    
```



Camera Setup

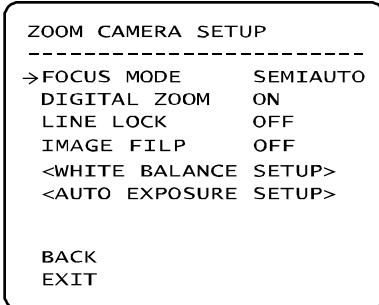

Setup the general functions of zoom camera module.

- Focus Mode [AUTO/MANUAL/SEMIAUTO]

Sets camera focus mode.

○ SEMIAUTO Mode

This mode exchanges focus mode automatically between Manual Focus mode and Auto Focus mode. Manual Focus mode activates in preset operation and Auto Focus mode activates when jog operation starts.

With Manual mode at presets, Focus data is memorized in each preset in advance and camera calls focus data in correspondence with presets as soon as camera arrives at a preset.

- Digital Zoom [ON/OFF]

Sets digital zoom function to ON/OFF. If this is set to OFF, optical zoom function runs but zoom function stops at the end of optical zoom magnification.

- Line Lock [ON/OFF]

If Line lock sync is ON, video signal is synchronized with AC power. Video can be fluctuated after setting is changed.

- Image Flip [ON/OFF]

To display Upside down image.

□ White Balance Setup

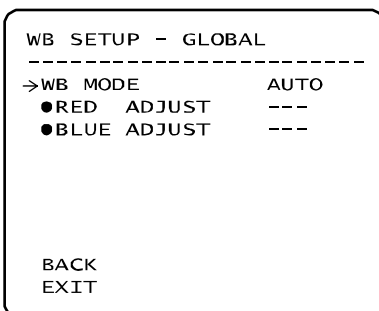

- WB Mode [AUTO/MANUAL]

In Manual mode, Red and Blue level can be set up manually

- Red Adjust [10~60]

- Blue Adjust [10~60]

☐ Auto Exposure Setup

AE SETUP - GLOBAL	

→BACKLIGHT	OFF
DAY/NIGHT	AUTO1
BRIGHTNESS	25
IRIS	AUTO
SHUTTER	ESC
AGC	NORMAL
SSNR	MIDDLE
SENS-UP	<AUTO>
BACK	
EXIT	

- Backlight [ON/OFF]
Sets Backlight Compensation
- Day/Night [AUTO1/AUTO2/DAY/NIGHT]
AUTO1 exchanges Day/Night mode faster than AUTO2.
- Brightness [0~100]
Adjusts brightness of images. Iris, Shutter Speed and Gain are adjusted automatically in correspondence with this value.
- IRIS [AUTO/MANUAL(0~100)]
If Iris is set to Auto, Iris should have highest priority in adjusting AE and Shutter Speed should be fixed.
If Iris is set to Manual, Iris should be fixed and Iris has lower priority in adjusting AE, in comparison with others.
- Shutter Speed [ESC/A. Flicker/Manual(×128~1/120000 sec)]
If Iris is set to Manual and Shutter Speed is set to ESC, Shutter Speed should have highest priority. If Shutter Speed is set to A. Flicker, to remove Flicker, Shutter Speed should be set to 1/100 sec. for NTSC and 1/120 for PAL.
- AGC [OFF/NORMAL/HIGH]
Enhances image brightness automatically in case that luminance level of image signal is too low.
- SSNR [OFF/LOW/MIDDLE/HIGH]
Enhances images by deducting noises when gain level of images is too high.
- SENS-UP [AUTO(2~128)/OFF]
Activates Slow Shutter function when luminance of image (signal) is too dark.
It is possible to set up the maximum number of frames piled up one on another by Slow Shutter function.

System Setup

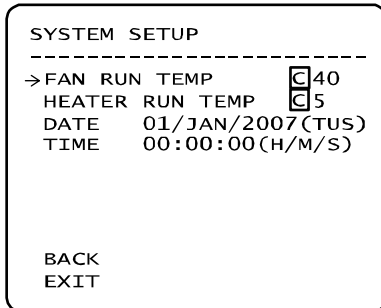

- **FAN RUN TEMP** Above this temperature, the blower fan will start automatically.
Range: 30 ~ 125°C (86 ~ 257°F)
- **HEATER RUN TEMP** Below this temperature, the Heater will be tuned on automatically.
Range: -55 ~ 20°C (-67 ~ 68°F)
- **DATE** Date is displayed in dd/mm/yy format. The day is automatically calculated when you set the day.
- **TIME** Time is displayed in HH:MM:SS format.
- **DATE/TIME Setup** After you press the **Near** key, each field can be selected by **Left/Right** keys and the values in the field are changed using **Up/Down** keys. To save the updated data, press the **Near** key again

System Initialize

```

SYSTEM INITIALIZE
-----
->CLEAR ALL DATA      NO
  ■ CLR DISPLAY SET    NO
  ■ CLR CAMERA SET     NO
  ■ CLR MOTION SET     NO
  ■ CLR FUNCTION SET   NO
  REBOOT CAMERA       NO
  REBOOT SYSTEM       NO

BACK
EXIT
    
```

- Clear All Data Deletes all configuration data such as display, camera, motion setup and so on.
- Clear Display Set Initializes Display Configuration
- Clear Camera Set Initializes Camera Configuration
- Clear Motion Set Initializes Motion Configuration
- Clear Function Se Deletes Preset Data, Scan Data, Pattern Data, Group Data and Schedule Data
- Reboot Camera Reboots Zoom Camera module
- Reboot System Reboots Speed Dome Camera

□ Initial Configuration Table

● Display Configuration		● Camera Configuration	
Camera ID	ON	Focus Mode	SemiAuto
PTZ Information	AUTO	Digital Zoom	ON
Action Title	AUTO	Line Lock	OFF
Preset Label	AUTO	Image Flip	OFF
Alarm I/O	AUTO	White Balance	AUTO
Date/Time	ON	Backlight	OFF
Temperature	CELSIUS	Day&Night	AUTO1
North Direction	Pan 0°	Brightness	25
Privacy Zone	Undefined	Iris	AUTO
		Shutter	ESC
		AGC	NORMAL
		SSNR	MIDDLE
		SENS-UP	AUTO (4 Frame)
● Motion Configuration		● Function Data	
Preset Lock	OFF	Preset 1~128	Undefined
Power Up Action	ON	Scan 1~8	Undefined
Auto Flip	ON	Pattern 1~4	Undefined
Jog Max Speed	140°/sec	Group 1~8	Undefined
Jog Direction	INVERSE	Schedule 1~7	Undefined
Freeze In Preset	OFF		
Park Action	OFF		
Alarm I/O Action	OFF		

Specifications

Model		10x	
Video Signal System		NTSC	PAL
Camera	CCD	1/4" Interline Transfer CCD	
	Max. Pixels	811(H)×508(V) 410K	795(H)×596(V) 470K
	Effective Pixels	768(H)×494(V) 380K	752(H)×582(V) 440K
	Horizontal Res.	500 TV Line(Color), 570 TV Line(B/W)	
	S/N Ratio	50 dB (AGC Off)	
	Zoom	×10 Optical Zoom, ×10 Digital Zoom	
	Focal length	F1.8, f=3.8~38mm	
	Min. illumination	0.7 Lux (Color) / 0.02 Lux (B/W), 50 IRE	
	Day & Night	Auto / Day / Night(ICR)	
	Focus	Auto / Manual / SemiAuto	
	Iris	Auto / Manual	
	Shutter Speed	x128 ~ 1/120000 sec	
	AGC	Normal / High / Off	
	White Balance	Auto / Manual(Red, Blue Gain Adjustable)	
	BLC	Low / Middle / High / Off	
	Flickerless	Selectable	
SSNR	Low / Middle / High / Off		
Pan/Tilt	Range	Pan : 360°(Endless) Tilt : 90° (Auto-Flip)	
	Pan/Tilt Speed	Preset : 360°/sec	
		Manual : 0.05 ~ 360°/sec (proportional to zoom)	
		Scan : 1~ 180°/sec	
	Preset	127 Preset (Label, Camera Image Setting)	
	Pattern	4 Pattern, 1200 commands(about 5 minute)/Pattern	
	Scan	8 Scan	
Group	8 Group (20 action entities per Group)		
Other Functions	Auto Flip, Auto Parking, Power Up Action etc.		
General	Communication	RS-485	
	Protocol	Pelco-D, Pelco-P selectable	
	Privacy Zone	4 Zone	
	Alarm Input	2 Input	
	Alarm Output	1 Relay Output	
	OSD	Menu / PTZ information etc	
	Rated Power	DC Type : DC 12V / 0.8A	
	Dimension	Dome : Ø100.5	
		Housing : Ø142 × 127(H) mm	
	Weight	about 850 g	
Operating Temp.	0°C ~ 40°C -30°C ~ 50°C (Fan & Heater Built-in type)		

* Specifications of this product can be subjected to change without notice.

■ Appearance

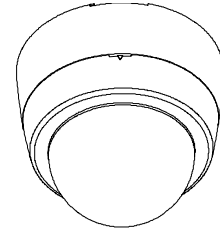

● Main Unit

Dimension

- Main Unit & Surface Mount Bracket

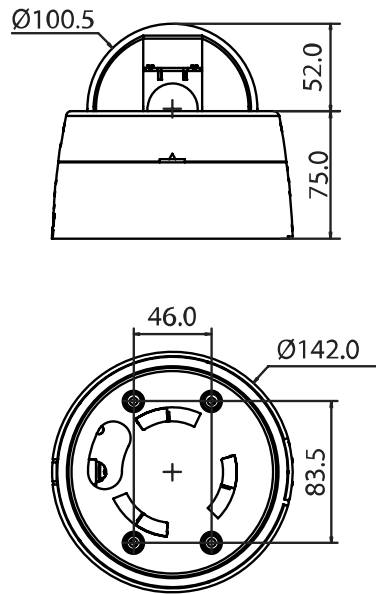

Unit (mm)