

INSTRUCTION MANUAL Ver 1.4

ANTIVANDAL OUTDOOR IP SPEED DOME CAMERA | MPEG4 with Motion Tracking

Firmware Ver. 1.2.1a





CAUTION
RISK OF ELECTRIC
SHOCK DO NOT OPEN



**CAUTION : TO REDUCE THE RISK OF ELECTRICAL SHOCK, DO NOT OPEN COVERS.
NO USER SERVICEABLE PARTS INSIDE.
REFER SERVICING TO QUALIFIED SERVICE PERSONAL.**



This lightning flash with arrowhead symbol is intended to alert the user to the presence of un-insulated "dangerous voltage" within the product's enclosure that may be of sufficient magnitude to constitute a risk of electric shock to persons.



This exclamation point symbol is intended to alert the user to the presence of important operating and maintenance (servicing) instructions in the literature accompanying the appliance.

**WARNING : TO PREVENT THE RISK OF FIRE OR ELECTRIC SHOCK HAZARD, DO NOT EXPOSE
THIS CAMERA TO RAIN OR MOISTURE.**



Important Safeguard

1. Read Instructions

Read all of the safety and operating instructions before using the product.

2. Retain Instructions

Save these instructions for future reference.

3. Attachments / Accessories

Do not use attachments or accessories unless recommended by the appliance manufacturer as they may cause hazards, damage product and void warranty.

4. Water and Moisture

Do not use this product near water or moisture.

5. Installation

Do not place or mount this product in or on an unstable or improperly supported location. Improperly installed product may fall, causing serious injury to a child or adult, and damage to the product. Use only with a mounting device recommended by the manufacturer, or sold with the product. To insure proper mounting, follow the manufacturer's instructions and use only mounting accessories recommended by manufacturer.

6. Power source

This product should be operated only from the type of power source indicated on the marking label.

Precautions

Operating

- Before using, make sure power supply and others are properly connected.
- While operating, if any abnormal condition or malfunction is observed, stop using the camera immediately and then contact your local dealer.

Handling

- Do not disassemble or tamper with parts inside the camera.
- Do not drop or subject the camera to shock and vibration as this can damage camera.
- Care must be taken when you clean the clear dome cover. Especially, scratch and dust will ruin your quality of camera.

Installation and Storage

- Do not install the camera in areas of extreme temperature, which exceed the allowable range.
- Avoid installing in humid or dusty places.
- Avoid installing in places where radiation is present.
- Avoid installing in places where there are strong magnetic fields and electric signals.
- Avoid installing in places where the camera would be subject to strong vibrations.
- Never expose the camera to rain and water.



① Introduction	
Features	6
About Network Function	8
Product & Accessories	9
Parts Name & Functions	10
② Installation	
Configure, fix and wire	12
DIP Switch Setup	13
Installation using Mount Bracket	15
Cabling	17
③ Operation	
Check points before operation	20
Preset and Pattern Function Pre-Check	20
Starting OSD Menu	21
Reserved Preset	21
Preset	22
Scan	22
Pattern	23
Group	24
Other Functions	25
OSD Display of Main Screen	26
④ How to use OSD Menu	
General Rules of Menu Operation	27
Main Menu	27
Display Setup	28
Privacy Zone Mask Setup	29
Dome Camera Setup	30
Preset Setup	36
Scan Setup	38
Pattern Setup	39
Group Setup	40
System Initialize	42
⑤ Network Setup	
DDNS Registration	43
Quick Start of Network Connection	44
Initial Setup via a Crossover Cable	46
Guide to Network Setup	49



Case A : Dynamic IP or PPPoE + Personal Router	50
Case B : Static(Fixed) IP + Personal Router	52
Case C : Static(Fixed) IP	54
Case D : Dynamic IP + DSL/Cable Modem	56
Case E : PPPoE + DSL Modem	57
Port Forwarding	58
Starting IP Speed Dome	59
⑥ Web Viewer	
Web Viewer Screen	60
How does Motion Tracking work?	64
Create, Save, Load Map	66
Preset	67
Group	68
Viewer Interface	69
⑦ Admin Tool	
Video Tool	70
Control Tool	72
Motion Detection Tool	73
Motion Tracking Tool	74
TCP/IP Tool	76
DDNS Tool	77
SMTP Tool	78
Date & Time Tool	79
Users Tool	80
Firmware Update Tool	81
Default Set Tool	82
Rebooting Tool	82
⑧ Appendix	
A : Current TCP/IP Setting	83
B : Changing your computer's IP address and subnet mask	84
C : Port Forwarding	85
⑨ FAQ	89
⑩ Specifications	93
Specifications	93
Dimension & Options	95



Features

❑ Network Video Interface

- High frame are using hardware MPEG4 compression.
- High frame rate with superior Video Quality
- High speed : 30 fps at 720 x 480, 25 fps at 720 x 576
- Web Browser based Viewer & i-Pro Multi Viewer supported.
- Remote control for Pan/Tilt & Sensor I/O.
- Bidirectional Audio support
- Support with DDNS Service (www.net4c.net) for Dynamic IP
- Hardware based Motion Detection function
- Hardware based Intelligent Motion Tracking Algorithm
- Auto Map Generation
- Virtual Joystick is inspired by real Joystick

❑ Camera Specifications

- CCD Sensor : 1/4" Interline Transfer CCD
- Zoom Magnification : × 18 Optical Zoom, × 120 Digital Zoom
- Zoom Magnification : × 36 Optical Zoom, × 120 Digital Zoom
- Day & Night Function
- Various Focus Mode : Auto-Focus / Manual Focus

❑ Powerful Pan/Tilt Functions

- Max. 360°/sec high speed Pan/Tilt Motion
- Using Vector Drive Technology, Pan/Tilt motions are accomplished in a shortest path. As a result, time to target view is reduced dramatically and the video on the monitor is very natural to watch.
- For jog operation using a controller, since ultra slow speed 0.05°/sec can be reached, it is very easy to locate camera to desired target view. Additionally it is easy to move camera to a desired position with zoom-proportional pan/tilt movement.

❑ PTZ(Pan/Tilt/Zoom) Control

- With RS-485 communication, max. 255 of cameras can be controlled at the same time.
- Pelco-D or Pelco-P protocol can be selected as a control protocol in the current version of firmware.



❑ Preset, Pattern, Scan, Group, Privacy Mask and More...

- Up to 127 sets of positional and zoom level information can be stored as presets. These can be called manually by the operator, automatically by an alarm input, or grouped to form a sequence of actions to run automatically. Each preset can also be programmed with the following:
 - Alarm action - relay outputs can be triggered when particular presets are called
 - Title - each preset can be titled with up to 10 characters so that zones can easily be identified
- Max. 8 set of Scan action can be stored. This enables to move camera repetitively between two preset positions with designated speed.
- Max. 4 of Patterns can be recorded and played back. This enables to move camera to follow any trajectory operated by joystick as closely as possible.
- Max. 8 set of Group action can be stored. This enables to move camera repetitively with combination of Preset or Pattern or Scan. A Group is composed of max. 20 entities of Preset/Pattern/Scans.
- Privacy Masks are assignable, not to intrude on other's privacy. (4 Privacy Zones)

❑ OSD(On Screen Display) Menu

- OSD menu is provided to display the status of camera and to configure the functions interactively.
- The information such as Camera ID, Pan/Tilt Angle, Alarm Input, Time and Date and Preset can be displayed on screen.

❑ Alarm I/O Functions

- This Dome has 8 alarm sensor Inputs and 4 Relay outputs.
- Any alarm input can be set to call a predefined preset, Scan function, pattern or group.
- Any preset can be configured to activate any or all of the alarm outputs.
- To reject external electric noise and shock perfectly, alarm sensor Input is decoupled with photo coupler.
- The signal range of sensor input is from DC 5.0 to 12.0 volts to adopt various applications.
- If an external sensor is activated, camera can be set to move to the corresponding Preset position.

❑ Reserved Presets for Special Purpose

- Most camera characteristics can be set up easily and directly with reserved preset, not entering into OSD menu. For more information, refer to "Reserved Preset" in this manual.

About Network Function

- This product is only compatible with current versions of the Microsoft Windows OS.
- This product operates with Microsoft's Internet Explorer only.
- You must have ActiveX controls enabled on your browser, found in the Options menu.
- Some pop-up blockers may block legitimate configuration screens, please disable these blockers when configuring the IP Speed Dome.
- Some hardware manufacturers include a cable/DSL modem, router/firewall, and Ethernet switch in one device.
- If you have no available ports on your router (with integrated switch) you can purchase a 10/100 Ethernet switch to "expand" your Local Area Network
- The crossover cable is not wired as a typical straight-through network cable. This cable (or any crossover) should be used for initial setup of the IP Speed Dome via a PC/laptop.
- Please temporarily disconnect any proxy servers associated with Internet Explorer while configuring the IP Speed Dome.

❑ Modification and Development

The Linux-based operating system and flash memory file system enable advanced users and application developers to customize the IP Speed Dome. An SDK developer kit is available for users to interface ActiveX controls and other applications.

Attempts to modify the IP Speed Dome will void all warranties and will not be supported by manufacturer or its seller. Further development tools and documentation for assistance may be accessible in future releases. We strongly recommend that inexperienced users DO NOT modify the firmware of IP Speed Dome.

The manufacturer or its seller will not be held accountable in a user's attempt to modify the IP Speed Dome that renders the unit inoperable or otherwise.

① This document is for Network firmware version 1.2.1a

Product & Accessories

☐ Product & Accessories

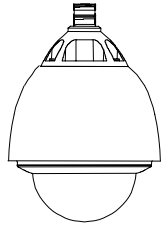

● Main Body

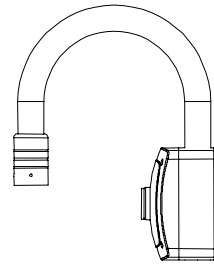

● Wall Mount Bracket

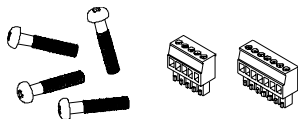

● Screws & Terminal Block

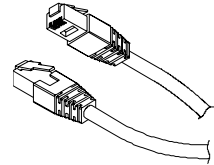

● Crossover Cable

☐ Options



● Ceiling Mount Bracket



● Corner Mount Bracket

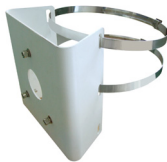

● Pole Mount Bracket

Parts Name & Functions

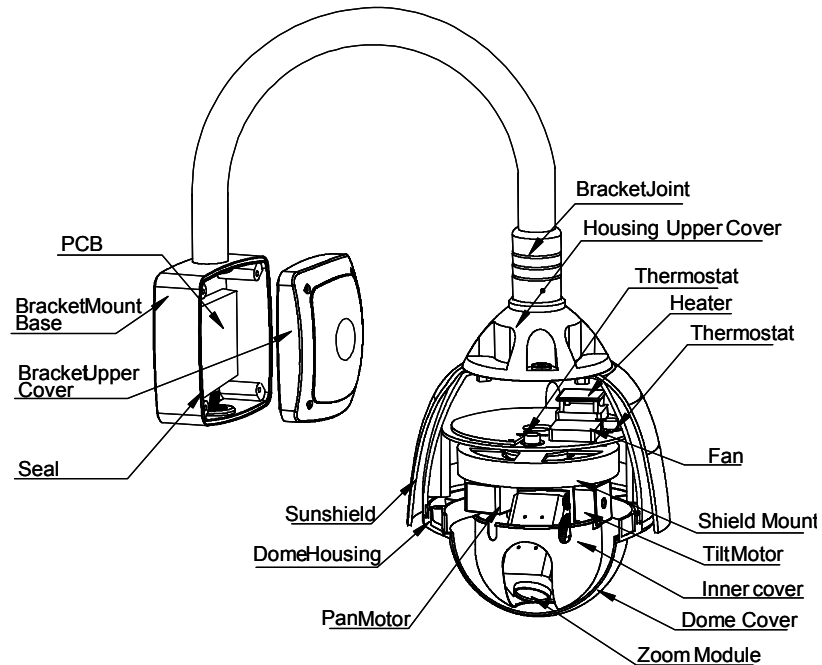

● Main Unit / Wall Mount Bracket

- Dome Cover
Do not detach protection vinyl from dome cover before finishing all installation process to protect dome cover from scratches or dust.
- Wall Mount Bracket
Wall bracket option. After making all the connections to the PCB, fit the junction box cover with the four screws.
- Cabling Terminal Block
During installation, Power, Video, Communication, Alarm Input cables are connected on to this cabling terminal block.
- DIP Switch
Adjusts camera ID and protocols.
- Ethernet Connector
This RJ-45 connector is for network connection and designed to operate on 10 or 100 Mbps.
- Reset Switch
Return all settings to their factory defaults. Care must be taken since you will lose all data made previously.
- ACTIVE LED
When in use, this Yellow indicator should always be flashing or flickering. During reboots or power cycling, it may take several seconds for the unit to initialize and illuminate the indicator.

- LINK LED

This green indicator should be flashing or glowing during normal operation. During a reboot or power cycling, it may take up to 50 seconds to initialize, negotiate your network speed, and begin operation at 10 or 100Mbps. If this light is not lit after 50 seconds of operation, check the network cable to ensure a proper connection. When a proper connection is met, the green indicator should immediately glow.

Configure, fix and wire

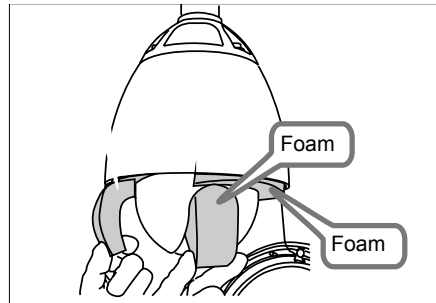
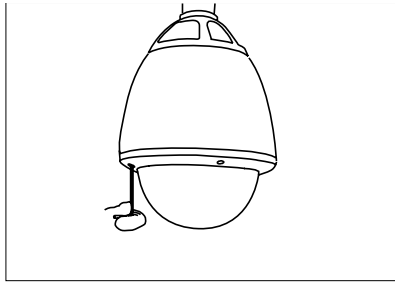

- ① Wearing the gloves and using the supplied tool, remove the outer dome cover.
- ② Remove the foam pieces from the camera module.

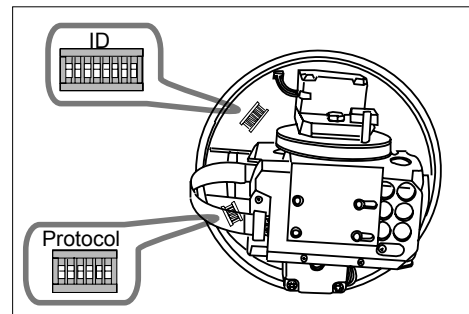
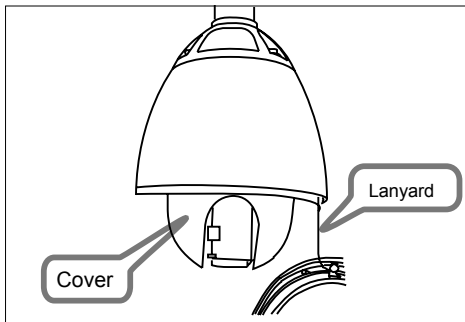

- ③ Carefully unclip the black inner dome
- ④ Locate the dip switches and set protocol and ID according to the next section.

**Note.

DIP Switch Setup

Before you installed camera or After you mount the camera, you should set the DIP switches properly to match your control equipment. Most important settings are camera ID, communication protocol and its speed. As Shown in the Picture bellow, there are two dip switch for protocol and ID

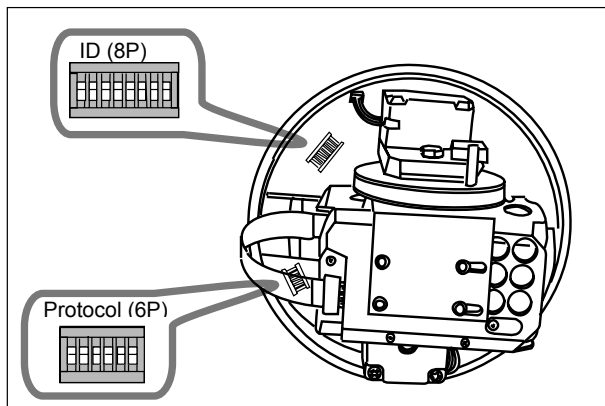

□ Camera ID Setup

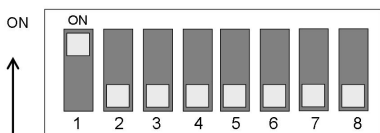

[Factory Default Setting]

- ID number of camera is set using binary number. The example is shown bellow.

Pin	1	2	3	4	5	6	7	8
ID Value	1	2	4	8	16	32	64	128
ex) ID=5	on	off	on	off	off	off	off	off
ex) ID=10	off	on	off	on	off	off	off	off

- The range of ID is 1~255. **Do not use 0 as camera ID.** Factory default of Camera ID is 1.
- If you want to control a certain camera, you must match the camera ID with Cam ID setting of DVR or Controller.

❑ Communication Protocol Setup

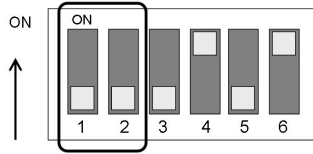

- Select the appropriate Protocol with DIP switch combination.

Switch State		Protocol
P0 (Pin 1)	P1 (Pin 2)	
OFF	OFF	PELCO-D, 2400 bps
ON	OFF	PELCO-D, 9600 bps
OFF	ON	PELCO-P, 4800 bps
ON	ON	PELCO-P, 9600 bps

- If you want to control using DVR or P/T controller, their protocol must be identical to camera. Otherwise, you can not control the camera.
- If you changed camera protocol by changing DIP S/W, the change will be effective after you reboot the camera.
- Factory default of protocol is “Pelco-D, 2400 bps”.

❑ Reserved for Supplier

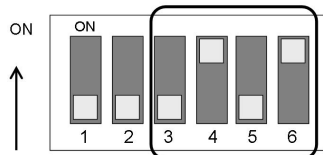

- Since Pin 3 ~ Pin 6 are reserved, DO NOT CHANGE THESE ITS ORIGINAL STATE. If you change one of these, proper operation can not be achieved.

Installation using Mount Bracket

- ① Fix the supplied mounting template, taking account of any pipework, cables, overhangs etc.that may obstruct the bracket once fitted.
- ② after making suitable checks fir buried pipes and cables, drill fixing holes suitable for the bolts supplied with the speed dome

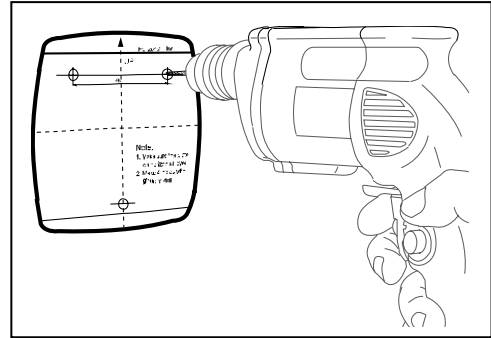
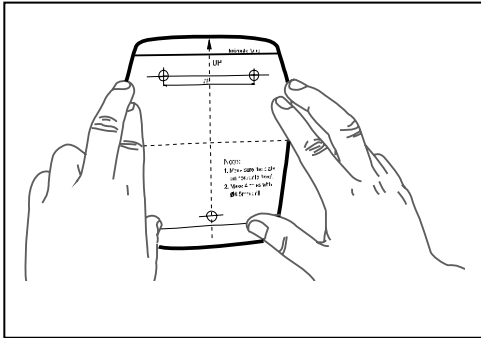

- ③ Remove the junction box cover. Using the supplied bolts and tool, firmly fix the bracket.
- ④ Feed the speed dome cable through the bracket.

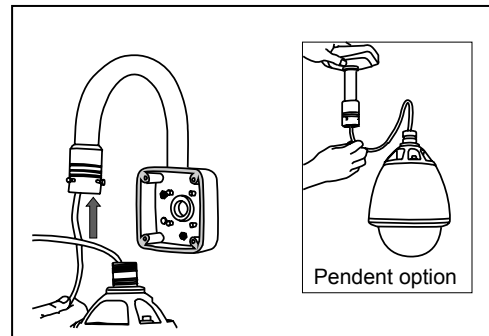
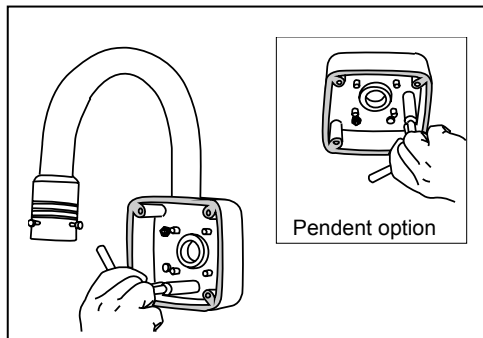

- ⑤ Bring the speed dome up to the bracket.
- ⑥ Tighten the three screws to fis the speed dome and ensure the lanyard safety chain is properly connected.

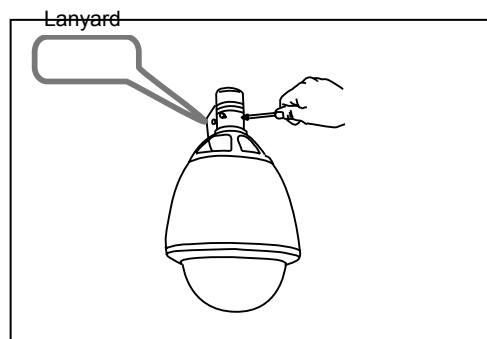
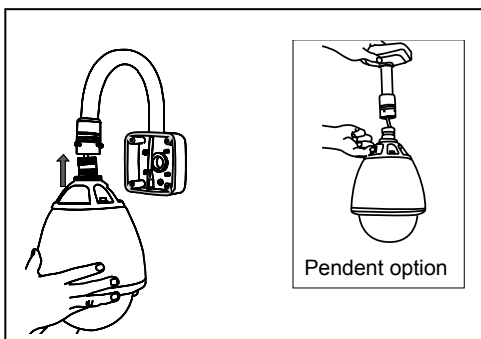

- ⑦ 1a-wall bracket option. After making all the connections to the PCB, fit the junction box cover with the four screws.

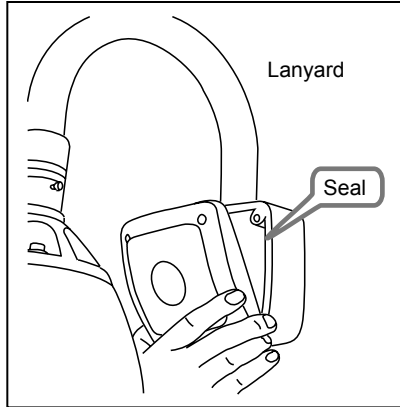

- ⑧ 1b-pendent option. After making all the connections to the PCB, raise the dome assembly to the junction box, connect the dome cable to the PCB and fix with the four screws.

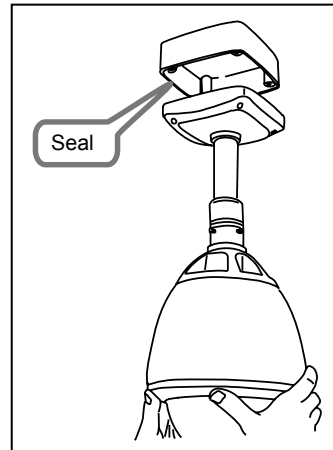

****Note:** when fixing the cover to the junction box, ensure that the seal is also fitted properly and that none of the cables are trapped

Cabling

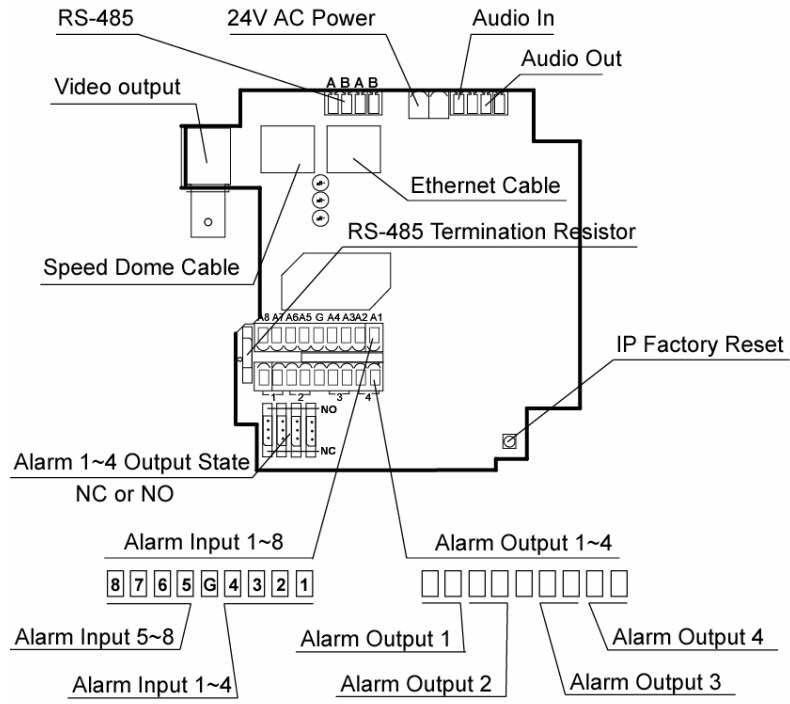

* NOTE: As shown in the drawing, you can change the type of Relay Out (NC or NO) by shifting the jumpers near by terminal blocks of Alarm Outputs.

Power Connection

- Please, check the voltage and current capacity of rated power carefully. Rated power is indicated in the back of main unit.

Rated Power	Input Voltage Range	Current Consumption
AC 24V	AC 17V ~ 29V	0.8 A

RS-485 Communication

- For PTZ control, connect this line to keyboard and DVR. To control multiple cameras at the same time, RS-485 communication lines of them is connected in parallel as shown below.

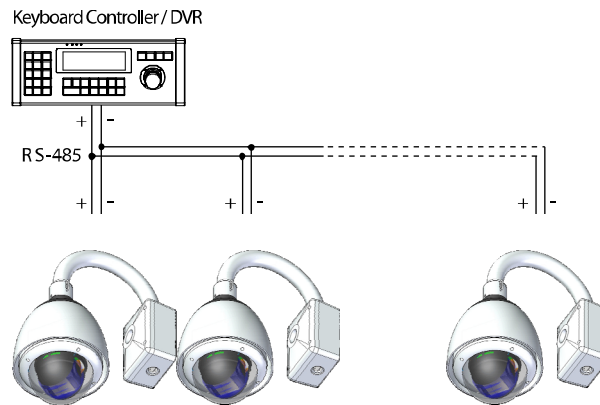

□ Video Connection

- Connect with BNC coaxial cable.

□ Alarm Input Connections

- Sensor Input

Alarm Input Circuit

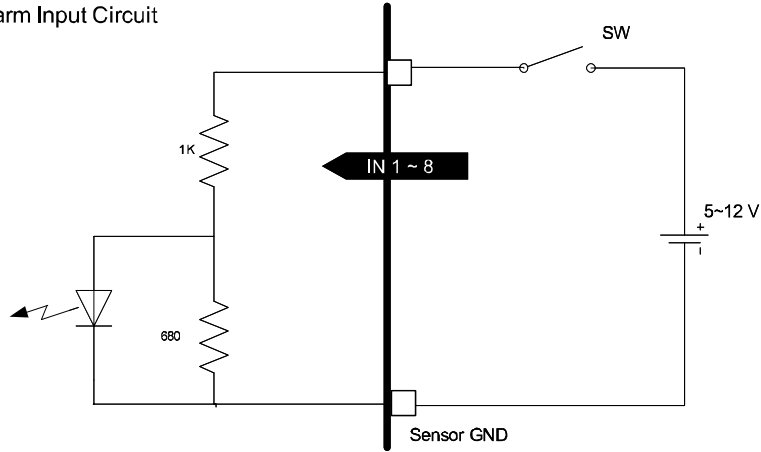

Before connecting sensors, check driving voltage and output signal type of the sensor. Since output signal types of the sensors are divided into Open Collector and Voltage Output type in general, the cabling must be done properly after considering these typed.

Signal	Description
IN #+	Connect (+) cable of electric power source for Sensors to this port as shown in the circuit above. Allowable voltage is 5 ~ 12 Volts DC.
GND	Common to all 8 Sensor input.

* NOTE: Type of sensor is fixed to NO type (Normally Open).

- Sensor Out

Alarm Output Circuit

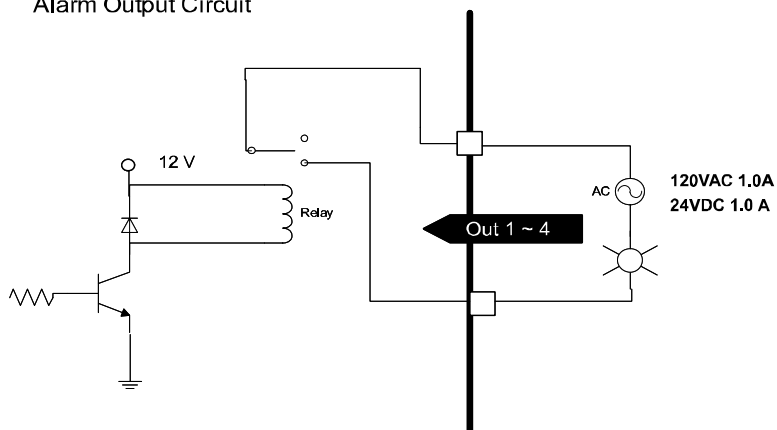

* NOTE: As shown in the drawing, you can change the type of Relay Out (NC or NO) by shifting the jumpers near by terminal blocks of Alarm Outputs.

Check points before operation

- Before power is applied, please check the cables carefully.
- The camera ID of the controller must be identical to that of the target camera. The camera ID can be checked by reading DIP switch of the camera.
- If your controller supports multi-protocols, the protocol must be changed to match to that of the camera.
- If you changed camera protocol by changing DIP switch, the change will be effective after you reboot the camera.
- Since the operation method can be different for each controller available, refer to the manual for your controller if camera can not be controlled properly. The operation of this manual is based on the standard Pelco® Controller.

Preset and Pattern Function Pre-Check

- Check how to operate preset and pattern function with controller or DVR in advance to operate camera function fully when using controller or DVR.
- Refer to the following table when using standard Pelco® protocol controller.

< Go Preset >	Input [Preset Number] and press [Preset] button shortly.
< Set Preset >	Input [Preset Number] and press [Preset] button for more than 2 seconds.
< Run Pattern >	Input [Pattern Number] and press [Pattern] button shortly.
< Set Pattern >	Input [Pattern Number] and press [Pattern] button for more than 2 seconds.

- If controller or DVR has no pattern button or function, use shortcut keys with preset numbers. For more information, refer to “Reserved Preset” in this manual.

Starting OSD Menu

- **Function** Using the OSD menu, Preset, Pattern, Scan, Group and Alarm Input function can be configured for each application.
- **Enter Menu** <Go Preset> [95]

Reserved Preset

- **Description** Some Preset numbers are reserved to special functions.
- **Function**
 - <Go Preset> [95] : Enters into OSD menu
 - <Go Preset> [131~134] : Runs Pattern Function 1 ~ 4
 - <Go Preset> [141~148] : Runs Scan Function 1 ~
 - <Go Preset> [151~158] : Runs Group Function 1 ~ 8
 - <Go Preset> [161~162] : Sets Relay Output 1 ~ 2 to OFF
 - <Set Preset> [161~162] : Sets Relay Output 1 ~ 2 to ON
 - <Go Preset> [170] : Sets Camera BLC Mode to OFF
 - <Go Preset> [171] : Sets Camera BLC Mode to ON
 - <Go Preset> [174] : Sets Camera Focus Mode to AUTO
 - <Go Preset> [175] : Sets Camera Focus Mode to Manual
 - <Go Preset> [176] : Sets Camera Focus Mode to SEMI-AUTO
 - <Go Preset> [177] : Sets Day & Night Mode to AUTO
 - <Go Preset> [178] : Sets Day & Night Mode to NIGHT
 - <Go Preset> [179] : Sets Day & Night Mode to DAY
 - <Go Preset> [190] : Sets OSD Display Mode to AUTO (Except Privacy Mask)
 - <Go Preset> [191] : Sets OSD Display Mode to OFF (Except Privacy Mask)
 - <Go Preset> [192] : Setting OSD Display Mode to ON (Except Privacy Mask)
 - <Go Preset> [193] : Sets all Privacy Mask Display to OFF
 - <Go Preset> [194] : Sets all Privacy Mask Display to ON



Preset

- **Function** Max. 127 positions can be stored as Preset position. The Preset number can be assigned from 1 to 128, but 95 is reserved for starting OSD menu.
Camera characteristics (i.e. White Balance, Auto Exposure) can be set up independently for each preset. Label should be blank and "Camera Adjust" should be set to "GLOBAL" as default. All characteristics can be set up in OSD menu.
- **Set Preset** <Set Preset> [1~128]
- **Run Preset** <Go Preset> [1~128]
- **Delete Preset** To delete Preset, use OSD menu.

Scan

- **Function** By using Scan function, you can make camera to move between 2 Preset positions repeatedly. When Scan function runs, camera moves from the preset assigned as the 1st point to the preset assigned as the 2nd point in CW(Clockwise) direction. Then camera moves from the preset assigned as the 2nd point to the preset assigned as the 1st point in CCW(Counterclockwise) direction.

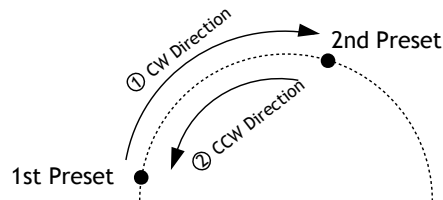

In case that the preset assigned as the 1st point is same as the preset assigned as the 2nd point, camera turns on its axis by 360° in CW(Clockwise) direction and then it turns on its axis by 360° in CCW(Counterclockwise) direction.

Speed can be set up from 1°/sec to 180°/sec.

- **Set Scan** To set Scan, use OSD menu.
- **Run Scan** Method 1) <Run Pattern> [Scan NO.+10] ex) Run Scan 3 : <Run Pattern> [13]
Method 2) <Go Preset> [Scan NO.+140] ex) Run Scan 3 : <Go Preset> [143]
- **Delete Scan** To delete Scan, use OSD menu.



Pattern

- **Function** Pattern Function is that a camera memorizes the path (mostly curve path) by joystick of controller for assigned time and revives the path exactly as it memorized.
4 Patterns are available and Maximum 1200 communication commands can be stored in a pattern.

- **Set Pattern** Pattern can be created by one of following two methods.

Method 1) <Set Pattern> [Pattern NO.]

- Pattern editing screen is displayed as bellow.

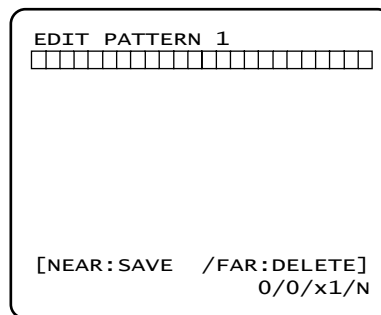

- Movement by Joystick and preset movement can be memorized in a pattern.
- The rest memory size is displayed in progress bar.
- To save the recording, press **NEAR** key and to cancel, press **FAR** key.

Method 2) OSD Using OSD Menu: See the section “How to use OSD Menu”.

- **Run Pattern** Method 1) <Run Pattern> [Pattern NO.] ex) Run Pattern 2 : <Run Pattern> [2]
Method 2) <Go Preset> [Pattern NO.+130] ex) Run Pattern 2: <Go Preset> [132]

- **Delete Pattern** Use OSD menu to delete a Pattern.

Group

- **Function** The group function allows running sequence of Presets, Pattern and/or Scans. Max 8 group can be stored. Each group can have max 20 action entities which can be preset, pattern or Scan. Preset speed can be set up and the repeat number of Pattern & Scan can be set up in Group setup. Dwell time between actions can be set up also.

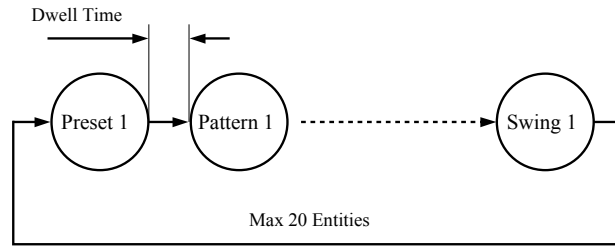

- **Set Group** Use OSD Menu to create a Group.
- **Run Group** Method 1) <Run Pattern> [Group NO.+20] ex) Run Group 7 : <Run Pattern> [27]
 Method 2) <Go Preset> [Group NO.++150] ex) Run Group 7 : <Go Preset> [157]
- **Delete Group** Use OSD Menu to delete.



Other Functions

- **Power Up Action** This function enables to resume the last action executed before power down. Most of actions such as Preset, Pattern, Scan and Group are available for this function but Jog actions are not available to resume.
- **Auto Flip** In case that tilt angle arrives at the top of tilt orbit (90°), zoom module camera keep moving to opposite tilt direction (180°) to keep tracing targets. As soon as zoom module camera passes through the top of tilt direction (90°), images should be reversed automatically and  appears in screen. If this function is set to OFF, tilt movement range is 0 ~ 95°.
- **Parking Action** This function enables to locate the camera to specific position automatically if operator doesn't operate the controller for a while. The Park Time can be defined as an interval from 1 minute to 4 hours.
- **Alarm Input** 4 Alarm Inputs are used. If an external sensor is activated, camera can be set to move to corresponding preset position. It is noted that the latest alarm input is effective if multiple sensors are activated.
- **Privacy Zone Mask** To protect privacy, MAX. 4 Privacy Masks can be created on the arbitrary position to hide objects such as windows, shops or private house. With Spherical Coordinates system, powerful Privacy Zone Mask function is possible.
- **GLOBAL/LOCAL Image Setup** WB(White Balance) and AE(Auto Exposure) can be set up independently for each preset. There are 2 modes, "Global" mode & "Local" mode. The Global mode means that WB or AE can be set up totally and simultaneously for all presets in "ZOOM CAMERA SETUP" menu. The Local mode means that WB or AE can be set up independently or separately for each preset in each preset setup menu. Each Local WB/AE value should activate correspondingly when camera arrives at each preset location.

During jog operation, Global WB/AE value should be applied. All Local WB/AE value do not change although Global WB/AE value changes.

OSD Display of Main Screen

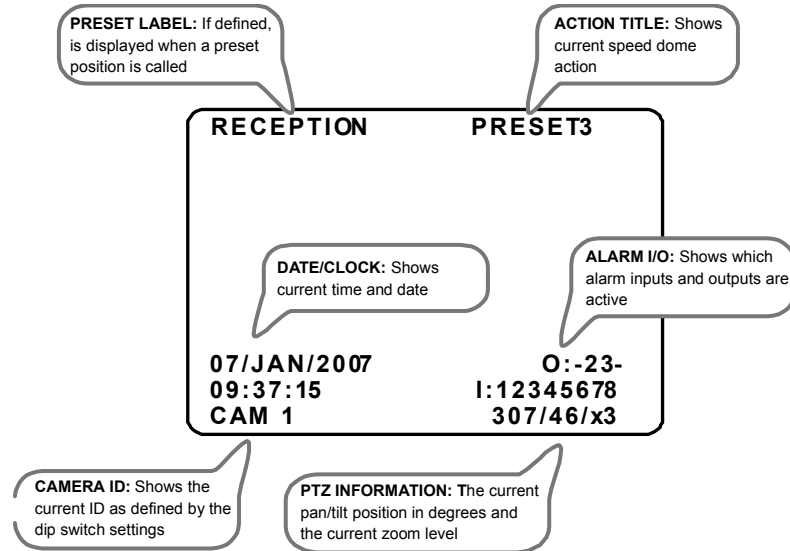

- P/T/Z Information Current Pan/Tilt angle in degree, zoom magnification and a compass direction.
- Camera ID Current Camera ID(Address).
- Action Title Followings are possible Action Titles and their meaning.

"SET PRESET xxx"	When Preset xxx is stored
"PRESET xxx"	When camera reach to Preset xxx
"PATTERN x"	When Pattern x is in action
"SWGx/PRESET xxx"	When Scan x is in action
"UNDEFINED"	When undefined function is called to run
- Preset Label The Label stored for specific Preset.
- Alarm Input This information shows current state of Alarm Input. If an Input point is **ON** state it will show a number corresponding to each point. If an Input point is **OFF** state, '-' will be displayed.
Ex) Point 2 & 3 of inputs are **ON**, OSD will show as below

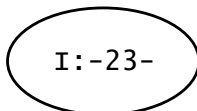

- Date and Clock Shows current real time and clock.

General Rules of Key Operation for Menu

- The menu items surrounded with () always has its sub menu.
- For all menu level, to go into sub menu, press **NEAR** key.
- To go to up-one-level menu, press **FAR** key.
- To move from items to item in the menu, use joystick in the **Up/Down** or **Left/Right**.
- To change a value of an item, use **Up/Down** of the joystick in the controller.
- Press **NEAR** key to save values and Press **FAR** key to cancel values.

Main Menu

SPEED DOME CAMERA

→<SYSTEM INFORMATION>
<DISPLAY SETUP>
<DOME CAMERA SETUP>

<PASSWORD SETUP>
<SYSTEM INITIALIZE>

EXIT

- System Information Displays system information and configuration.
- Display Setup Enable/Disable of OSD display on Main Screen.
- Dome Camera Setup Configure various functions of this camera.
- Password Setup Allows a password to be set to protect the speed dome set up.
- System Initialize Initializes system configuration and sets all data to factory default configuration.

Display Setup

□ Display Setup

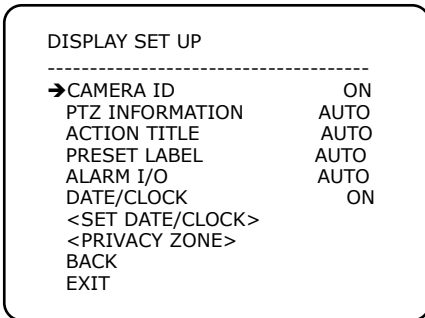

This menu defines Enable/Disable of OSD display on Main Screen. If an item is set to be AUTO, the item is displayed only when the value of it is changed.

- Camera ID [ON/OFF] shows camera ID according to the DIP switch settings, eg CAM1
- PTZ Information [ON/OFF/AUTO] shows the current pan/tilt position and degrees and the current zoom level
- Action Title [ON/OFF/AUTO] shows current speed dome action, eg PRESET3.
- Preset Label [ON/OFF/AUTO] shows preset title (if defined) when a preset is called.
- Alarm I/O [ON/OFF/AUTO] shows real time status of the alarm inputs and outputs.
- <Set Date/Clock> Sub menu to change the date and time
- <Privacy Zone> Sub menu to setup the speed dome privacy zone.

**Highlight the item to modify and key: NEAR

Use the joystick to change the setting and key: NEAR to save or FAR to cancel.

□ Set date/clock

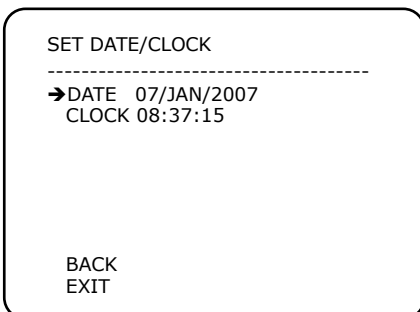

From the display setup menu, use the joystick to highlight SET DATE/CLOCK and key: NEAR

Highlight the item to modify and key : NEAR

Move the joystick up and down to change an individual value and left and right to move to the previous next value.

Key: NEAR to save or FAR to cancel.

Privacy Zone Mask Setup

From the display setup menu, use the joystick to highlight PRIVACY ZONE and key : NEAR

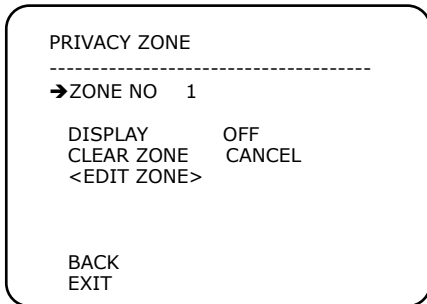

Select area in image to mask.

- Mask No [1~8]
Select Mask number. If the selected mask has already data, camera moves as it was set. Otherwise, "UNDEFINED" will be displayed under "Mask NO".
- Display [ON/OFF]
Sets if camera makes mask shows or not on images.
- Clear Mask [CANCEL/OK]
Deletes data in the selected mask NO.

□ Privacy Zone Area Setup

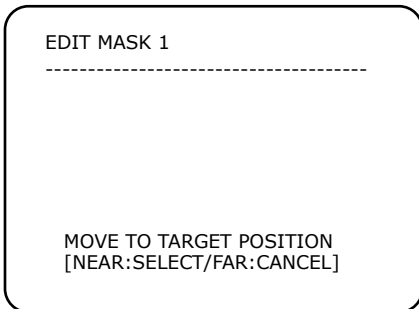

Move camera to area to mask. Then the menu to adjust mask size will be displayed

□ Privacy Zone Size Adjustment

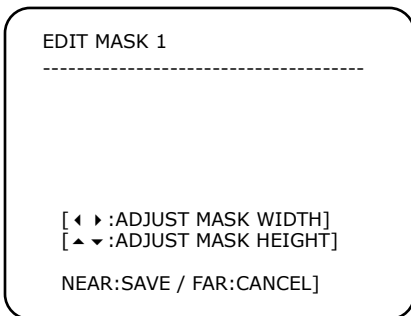

Adjust mask size. Use joystick or arrow buttons to adjust mask size.

- ◀ ▶ (Left/Right) Adjusts mask width.
- ▲ ▼ (Up/Down) Adjusts mask height.



Dome Camera Setup

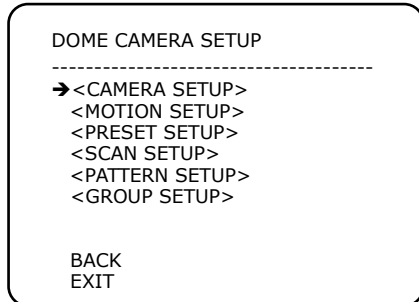

From the main menu, use the joystick to highlight DOME CAMERA SET UP and key: NEAR

- Camera setup setup of specific camera module features.
- Motion setup setup of pan/tilt/zoom operation if the speed dome, park action configuration ,and configuration of the alarm inputs.
- Preset setup Full management and programming of individual presets.
- Swing setup Full management and programming of swing functions.
- Pattern setup Full management and programming of patterns.
- Group setup Full management and programming of group functions.

**Highlight the item to modify and key: NEAR

**Remember : A menu item surrounded by brackets shows it has a sub menu.

❑ Camera Setup

ZOOM CAMERA SETUP

```

-----
-> FOCUS MODE      AUTO
   DIGITAL ZOOM   ON
   FLICKERLESS    OFF
   COLOUR         ON
   <WHITE BALNCE SETUP>
   <AUTO EXPOSURE SETUP>

   BACK
   EXIT
    
```

From the dome camera setup menu use the joystick to highlight CAMERA SETUP and key : NEAR

● Focus Mode [AUTO/MANUAL/SEMIAUTO]

Sets camera focus mode.

○ SEMIAUTO Mode

This mode exchanges focus mode automatically between Manual Focus mode and Auto Focus mode. Manual Focus mode activates in preset operation and Auto Focus mode activates when jog operation starts.

With Manual mode at presets, Focus data is memorized in each preset in advance and camera calls focus data in correspondence with presets as soon as camera arrives at a preset.

● Digital Zoom [ON/OFF]

Sets digital zoom function to ON/OFF. If this is set to OFF, optical zoom function runs but zoom function stops at the end of optical zoom magnification.

● FLICKERLESS [ON/OFF]

Should be set to ON when used in certain lighting conditions (EG Fluorescent lighting) to prevent picture flicker.

● COLOUR [ON/OFF]

Switches the modules between colour and b/w mode

● <WHITE BALANCE>

Sub menu to change the white balance settings

● <AUTO EXPOSURE>

Sub menu to change the auto exposure settings

❑ White Balance Setup

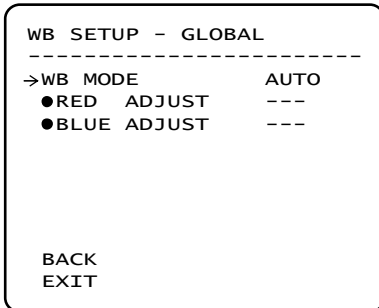

From the dome camera setup menu, use the joystick to highlight CAMERA SETUP and key : NEAR

- WB Mode [AUTO/MANUAL]

In Manual mode, Red and Blue level can be set up manually

AUTO—the speed dome determines the optimum white balance settings for a given scene.

MANUAL—the operator can adjust white balance settings manually

- Red Adjust [10~60]

in manual mode, the red colour content can be adjusted

- Blue Adjust [10~60]

in manual mode, the blue colour content can be adjusted

Highlight the item to modify and key : NEAR

Use the joystick to change the setting and key : NEAR to save or

FAR to cancel.

☐ Auto Exposure Setup

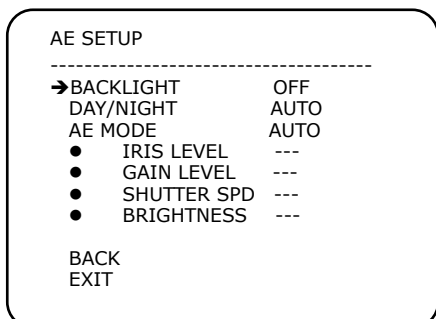

- Backlight [ON/OFF]
Sets Backlight Compensation
- Day/Night [AUTO/DAY/NIGHT]
The operator can choose to the camera in to DAY(colour) or NIGHT (B/W with IR cut filter mode).In AUTO mode, the camera switches between DAY and NIGHT depending on the surrounding light level
- AE mode
In AUTO mode, the speed dome determines optimum camera exposure settings for a givens scene.In the modes other than AUTO,the operator can adjust specific exposure characteristics to suit a particular scene
- IRIS [AUTO/MANUAL(0~100)]
If Iris is set to Auto, Iris should have highest priority in adjusting AE and Shutter Speed should be fixed.
If Iris is set to Manual, Iris should be fixed and Iris has lower priority in adjusting AE, in comparison with others.
- GAIN Level [OFF/NORMAL/HIGH]
Enhances image brightness automatically in case that luminance level of image signal is too low.
- Shutter Speed [ESC/A.Flicker/Manual(×128~1/120000 sec)]
If Iris is set to Manual and Shutter Speed is set to ESC, Shutter Speed should have highest priority. If Shutter Speed is set to A.Flicker, to remove Flicker, Shutter Speed should be set to 1/100 sec. for NTSC and 1/120 for PAL.
- Brightness [0~100]
Adjusts brightness of images. Iris, Shutter Speed and Gain are adjusted automatically in correspondence with this value.

Highlight the item to modify and key : NEAR

Use the joystick to change the setting and key :NEAR to save or

FAR to cancel.

❑ Motion Setup

```

MOTION SETUP
-----
-> PRESET LOCK      OFF
    PWR UP ACTION  ON
    AUTO FLIP      ON
    JOG MAX SPEED  120/SEC
    JOG DIRECTION  INVERSE
    <PARKING ACTION SETUP>
    <ALARM INPUT SETUP>

    BACK
    EXIT
    
```

Setup the general functions of Pan/Tilt motions.

- Preset Lock [ON/OFF]
If Preset Lock is set to ON, it is impossible to set up and delete Preset, Swing, Pattern and Group. It is possible only to run those functions. To set up and delete those functions, enter into OSD menu.
- Power Up Action [ON/OFF]
Refer to "Other Functions" section.
- Auto Flip [ON/OFF]
Refer to "Other Functions" section.
- Jog Max Speed [1°/sec ~360°/sec]
Sets maximum jog speed. Jog speed is inversely proportional to zoom magnification. As zoom magnification goes up, pan/tilt speed goes down.
- Jog Direction [INVERSE/NORMAL]
If you set this to 'Inverse', the view in the screen is moving same direction with jog tilting. If 'Normal' is selected, the view in the screen is moving reversely.

❑ Parking Action Setup

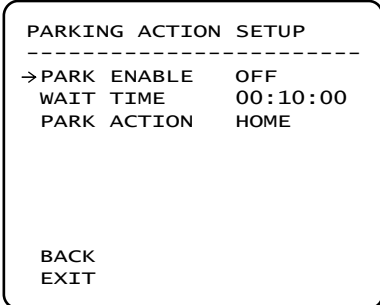

If Park Enable is set to ON, camera runs assigned function automatically if there is no PTZ command during assigned "Wait Time".

- Park Enable [ON/OFF]
- Wait Time [1 minute ~ 4 hour]
 The time is displayed with "hh:mm:ss" format and you can change this by 1 min unit.
- Park Action [HOME/PRESET/PATTERN/SWING/GROUP]
 ○ HOME
 Camera moves to home position if there is no PTZ command during assigned "Wait Time".

❑ Alarm Input Setup

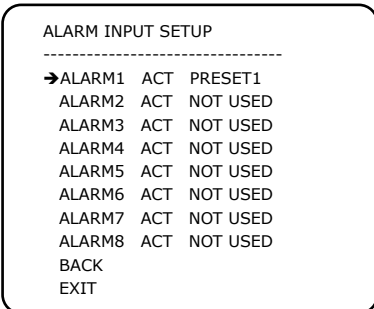

Match the Alarm sensor input to one of Preset positions. If an external sensor is activated, camera will move to corresponding preset position when this item is predefined.

- Alarm × Action [NOT USED/PRESET 1~128]
 Assign counteraction Preset position to each Alarm input.

Preset Setup

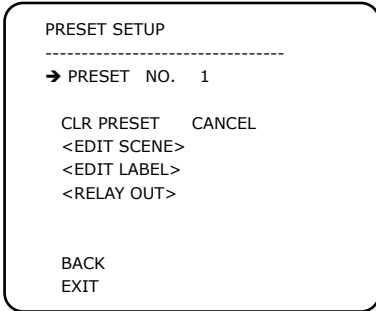

- **Preset Number** [1~128]
If a selected preset is already defined, camera moves to pre-defined position and preset characteristics such as Label and Relay Outputs show on monitor. If a selected preset is not defined, “UNDEFINED” shows on monitor.
- **Clear Preset** [CANCEL/OK]
Delete current Preset data
- **Edit Preset Scene** Redefine current Preset scene position (i.e. PTZ).
- **Edit Preset Label** Edits Label to show on monitor when preset runs. MAX. 10 alphabets are allowed.
- **Relay Out** There are 4 relay output in the Junction box.
In this Sub menu, you can make each relay output turn on whenever a designated preset is called. For example, it may be used when you want to turn on a light if Preset number 1 is executed. If the preset is in the Group, you will have a clearer image during night time.

❑ Edit Preset Scene

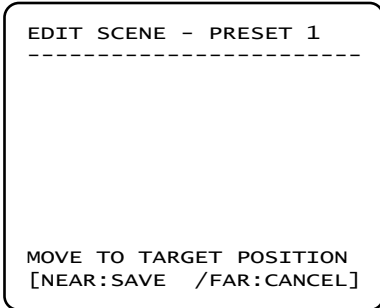

- ① Using Joystick, move camera to desired position.
- ② By pressing **NEAR** key, save current PTZ data.
- ③ Press **FAR** key to cancel.

❑ Edit Preset Label

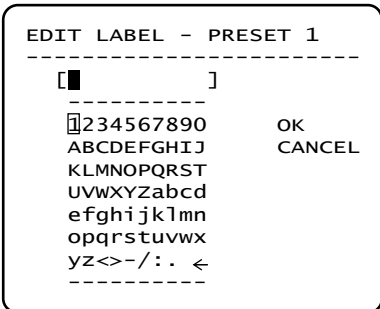

- ① Edits label to show on monitor when camera arrives at presets. In Edit Label menu, a reverse rectangular is cursor. As soon as finishing selecting alphabet, cursor moves to the next digit.

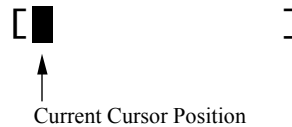

- ② Using **Left/Right/Up/Down** of joystick, move to an appropriate character from the Character set. To choose that character, press the **NEAR** key.

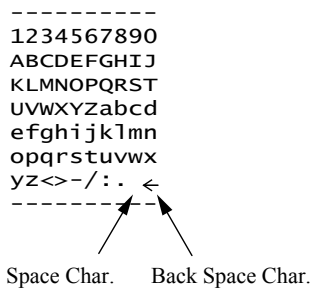

If you want to use blank, choose Space character (" "). If you want to delete a character before, use back space character ("←").

- ③ If you complete the Label editing, move cursor to "OK" and press **NEAR** key to save completed label. To abort current change, move cursor to "Cancel" and press **NEAR** key.

Scan Setup

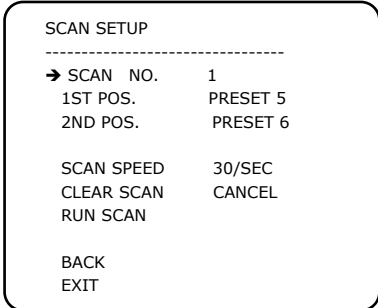

- SCAN Number [1~8]
Selects Scan number to edit. If a selected Scan has not defined, "NOT USED" is displayed in 1st Position and 2nd Position
- 1st Position [PRESET 1~128]
2nd Position Set up the 2 position for Scan function. If a selected preset is not defined, "UNDEFINED" will be displayed as shown below.

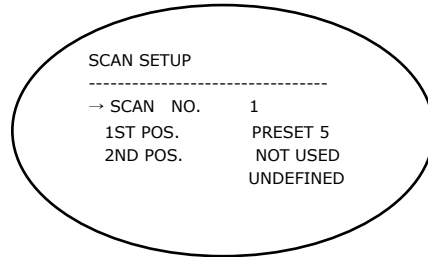

When Scan function runs, camera moves from the preset assigned as the 1st point to the preset assigned as the 2nd point in CW(Clockwise) direction. Then camera moves from the preset assigned as the 2nd point to the preset assigned as the 1st point in CCW(Counterclockwise) direction. In case that the preset assigned as the 1st point is same as the preset assigned as the 2nd point, camera turns on its axis by 360° in CW direction and then it turns on its axis by 360° in CCW direction.

- Scan Speed [1°/sec ~180°/sec]
Sets Scan speed from 1°/sec to 180°/sec.
- Clear Scan [CANCEL/OK]
Deletes current Scan data.



Pattern Setup

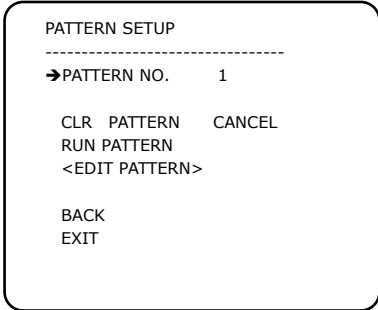

- Pattern Number [1~4]
Selects Pattern number to edit.
If a selected pattern number is not defined, "UNDEFINED" will be displayed under selected pattern number.
- Clear Pattern [CANCEL/OK]
Deletes data in current pattern
- Edit Pattern Starts editing pattern.

□ Edit Pattern

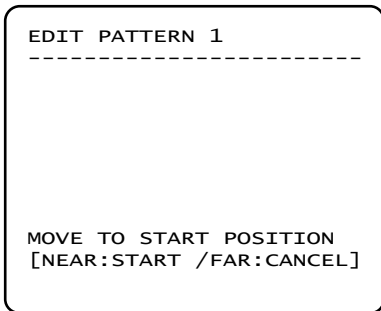

① By using Joystick, move to start position with appropriate zoom. To start pattern recording, press **NEAR** key. To exit this menu, press **FAR** key.

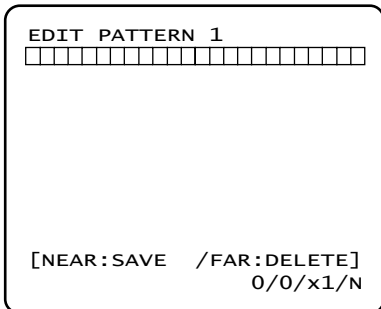

② Move camera with joystick of controller or run preset function to memorize the path (mostly curve path) in a selected pattern. The total memory size and the rest memory size is displayed in the form of bar. Maximum 1200 communication commands can be stored in a pattern.

③ To save data and exit, press **NEAR** key. To cancel recording and delete record data, press **FAR** key.

Group Setup

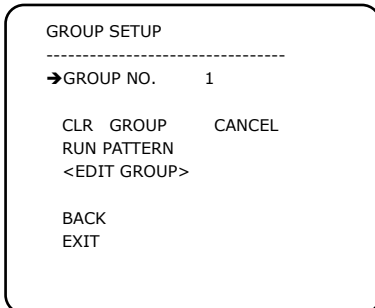

- Group Number [1~8]
Selects Group number to edit.
If a selected Group number is not defined, "UNDEFINED" will be displayed under selected Group number.
- Clear Group [CANCEL/OK]
Deletes data in current Group
- Edit Group Starts editing Group.

□ Edit Group

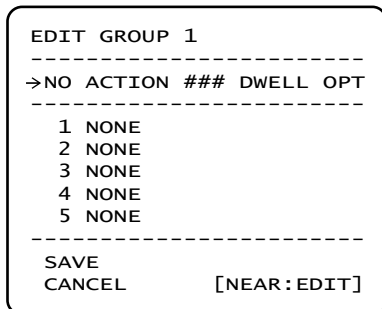

① Press **Near** key in "NO" list to start Group setup.

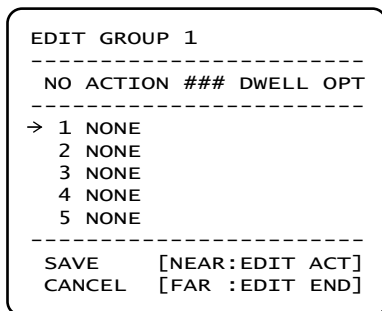

② Note that MAX. 20 Functions are allowed in a Group. Move cursor up/down and press **Near** key to set up.

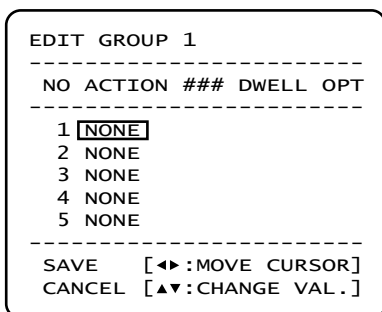

③ Set up Action, Dwell time and Option. Note that selected item is displayed in reverse. Move cursor **Left/Right** to select items and move cursor **Up/Down** to change each value.

- Action ### [NONE/PRESET/SCAN/PATTERN]
- DWELL [0 second ~ 4 minutes]
Sets Dwell Time between functions
- OPT Option. It should be preset speed when preset is set in Action. It should be the number of repeat when Pattern or Scan is selected in Action

```

EDIT GROUP 1
-----
NO ACTION ### DWELL OPT
-----
1 PRESET  [1] 00:03 360
2 NONE
3 NONE
4 NONE
5 NONE
-----
SAVE  [◀▶:MOVE CURSOR]
CANCEL [▲▼:CHANGE VAL.]
    
```

- ④ Set up items such as Action, ###, Dwell and OPT.

```

EDIT GROUP 1
-----
NO ACTION ### DWELL OPT
-----
-> 1 PRESET  1 00:03 360
2 NONE
3 NONE
4 NONE
5 NONE
-----
SAVE      [NEAR:EDIT ACT]
CANCEL   [FAR :EDIT END]
    
```

- ⑤ After finishing setting up a Action, press **Near** key to one-upper-level menu(Step ②). Move cursor **Up/Down** to select Action number and repeat Step ② ~ Step ④ to edit selected Group.

```

EDIT GROUP 1
-----
NO ACTION ### DWELL OPT
-----
1 PRESET  1 00:03 360
2 NONE
3 NONE
4 NONE
5 NONE
-----
->SAVE
CANCEL
    
```

- ⑥ After finishing setting up all Actions, press **FAR** key to exit. Then cursor should be moved to "SAVE". Press **Near** key to save data.

System Initialize

```

SYSTEM INITIALIZE
-----
->CLEAR ALL DATA      NO
●CLR DISPLAY SET      NO
●CLR CAMERA SET       NO
●CLR MOTION SET       NO
●CLR EDIT DATA       NO
REBOOT CAMERA         NO
REBOOT SYSTEM         NO

BACK
EXIT
    
```

- Clear All Data Deletes all configuration data such as display, camera, motion setup and so on.
- Clear Display Set Initializes Display Configuration
- Clear Camera Set Initializes Camera Configuration
- Clear Motion Set Initializes Motion Configuration
- Clear Edit Data Deletes Preset Data, Swing Data, Pattern Data and Group Data
- Reboot Camera Reboots Zoom Camera module
- Reboot System Reboots Speed Dome Camera

Initial Configuration Table

● Display Configuration		● Camera Configuration	
Camera ID	ON	Focus Mode	SemiAuto
PTZ Information	AUTO	Digital Zoom	ON
Action Title	AUTO	Line Lock	OFF
Preset Label	AUTO	White Balance	AUTO
Alarm Input	AUTO	Backlight	OFF
North Direction	Pan 0°	Day&Night	AUTO1
Privacy Zone	Undefined	Brightness	25
		Iris	AUTO
		Shutter	ESC
		AGC	NORMAL
		SSNR	MIDDLE
		SENS-UP	AUTO (4 Frame)
● Motion Configuration		● User Edit Data	
Preset Lock	OFF	Preset 1~128	Undefined
Power Up Action	ON	Scan 1~8	Undefined
Auto Flip	ON	Pattern 1~4	Undefined
Jog Max Speed	120°/sec	Group 1~8	Undefined
Jog Direction	INVERSE		
Freeze In Preset	OFF		
Park Action	OFF		
Alarm Action	OFF		

 **DDNS Registration**

If you have DYNAMIC IP service from your Internet Service Provider (ISP), you can't tell what current IP address of IP Speed Dome is. To solve this problem, you have to register to our DDNS service.

At first, we recommend, you have to check if you are using dynamic addressing. If so, please, register your IP Speed Dome Camera on our DDNS website before you configure, setup, or install the IP Speed Dome.

Even though your IP is not dynamic, you will get a benefit if you register to DDNS. In this case, you just remember "alex.net4c.net/gate1" instead of complicated series of number like <http://201.23.4.76:8078>.

For more detail information, please contact our Support Center.

※ To register IP Camera to DDNS, you should know the Serial No of your IVI. The Serial No can be found in "IP Status" menu of Admin Tool.

※ To use a public DDNS called DtDNS, you can find detail information on how to use this service. (Please, visit its web site : <http://www.dtdns.com>)

Quick Start of Network Connection

Please follow the steps below to complete the initial setup of the Network Function.

- ① Please do not power on the IP Speed Dome until instructed.
 - ① Temporarily disable any proxy servers configured in Internet Explorer.
 - ① If connecting the IP Speed Dome directly to a modem, power down and reset the modem. Leave the modem powered down until configurations are finalized with the IP Speed Dome and the IP Speed Dome has been correctly connected to the modem.
- ① You will need to access a PC/laptop and should configure that PC in order to communicate with the IP Speed Dome. Record the current TCP/IP properties of that PC (IP address, subnet mask, gateway, DNS, etc)
- ① If your PC obtains its IP address automatically, then there is no need to record any information.
- ② Change the IP address of that host PC to 192.168.1.11 and subnet mask to 255.255.255.0 (leave all other entries blank)
- ③ Connect the IP Speed Dome to your PC's Ethernet port via the supplied crossover cable (it does not matter what end is used for the PC)
- ④ Power on the IP Speed Dome using the supplied power adapter.
- ⑤ After 50 seconds of power, verify a flashing ACTIVE indicator, and a flashing or solid LINK indicator. After the corresponding indicator lights are properly displayed, open Internet Explorer.
- ⑥ Type - <http://192.168.1.80> (the default IP of the IP Speed Dome) into your address bar.
- ⑦ Default ID/Password to access IP Speed Dome are both the word: admin
- ⑧ Familiarize yourself with the Viewer Interface Screen.
- ⑨ Locate the TCP/IP configuration under Administration Tools. Supply the same ID and Password to enter Administration Tools (admin:admin)
- ⑩ Under "Network Type" select STATIC. You will only select Dynamic or PPPoE if you are connecting the IP Speed Dome directly to your cable/DSL/Broadband modem and your Internet Service Provider is supplying you a dynamic or PPPoE address.
- ① If you have a network with other devices (such as PC/laptop, etc.) or a router, you will NEVER select Dynamic or PPPoE.

- ⑪ Configure the IP Speed Dome's TCP/IP settings as you would any other PC on your network, providing a proper IP address, subnet mask, default gateway, and DNS server.

① If this is standalone unit with a direct connection to a cable/DSL/Broadband modem then input the addresses you have received from your ISP. If you received no IP address from your ISP, please select Dynamic or PPPoE and choose the proper settings.

- ⑫ The IP Speed Dome utilizes five TCP ports - a Web Server Port for utilizing Internet Explorer, a Video Server Port, a Control Server Port, Audio ports. A Web Server Port is for utilizing Internet Explorer, a Video Server port is to support the streaming video, and a Control Server Port is to transmit to control command. Also Audio Port are to transmit and to receive Audio data. If this IP Speed Dome will be directly attached to a cable/DSL/Broadband modem or has been assigned a static IP from your ISP, then leave the default port settings. If you are installing the IP Speed Dome on a network, you must define a Web Server Port other than 80. The other ports, a Video Server Port, a Control server Port, Audio Ports can remain unchanged.
- ⑬ If the IP Speed Dome is connected to a network which utilizes a router, you must have Port Forwarding configured on your personal router to forward all ports to the IP address you have assigned the IP Speed Dome.
- ⑭ After configuring Port Forwarding on your router (if necessary), you may then access your IP Speed Dome on your local network by opening Internet Explorer and specifying the IP address and Web Server Port that you have assigned to the IP Speed Dome.

① Examples: <http://192.168.0.200:8888> or <http://24.106.88.123>

① If you left your Web Server Port set to 80, then you don't need to specify the port in the Address Bar when accessing your IP Speed Dome.

- ⑮ Access your IP Speed Dome via the Internet :

If you used a static IP address assigned by your ISP

- i) Open Internet Explorer.
- ii) Type the IP of the IP Speed Dome.
- iii) If you use a router, type the routers' static IP and the web port number of the IP Speed Dome.

If you have a dynamic address provided by your ISP

- i) Open Internet Explorer and visit the DDNS website.
- ii) Register the IP Speed Dome.
- iii) Reboot the IP Speed Dome.
- iv) Give the DDNS server 2 minutes to locate your IP Speed Dome's IP information.
- v) Click the refresh button in the Internet Explore.
- vi) After your camera is connected, select your camera.

Initial Setup via a Crossover Cable

This section provides a guide on how to connect the IP Speed Dome to your PC/laptop for initial setup.

Please follow the instructions in the order they appear, without skipping steps. Do not supply power to the IP Speed Dome, until instructed.

In order to access the IP Speed Dome’s firmware you will need to connect the Video Server directly to a PC or laptop computer via the supplied crossover cable.

- ① Before you begin, you must determine the current network/INTERNET (TCP/IP) settings on the PC or laptop you plan to setup the IP Speed Dome. Jot down your entries below for quick reference.

❗ For information on how to determine your current settings, see Appendix A

Current TCP/IP Settings	
IP Address	
Subnet Mask	
Default Gateway	
Primary DNS Server	
Secondary DNS Server (Option)	

- ② In order for the IP Speed Dome to communicate with your PC, you have to change your PC’s IP address and subnet mask

❗ We recommend that you change your IP address to 192.168.1.11 and change the subnet mask to 255.255.255.0
 Leave all other entries (Default Gateway, DNS Servers, etc.) blank.

❗ For information on how to change your IP address and subnet mask, see Appendix B

- ③ After you have made the changes to your IP address and subnet mask, you may then attach the IP Speed Dome to your PC via the supplied crossover cable. Plug-in either end of the crossover cable into the PC’s network card and the other end into your IP Speed Dome.
- ④ After connecting the PC and IP Speed Dome using the crossover cable, power on the IP Speed Dome by plugging in the power supply shipped with the IP Speed Dome.
- ⑤ No longer than 1 minute after powering on the IP Speed Dome, verify that the ACTIVE indicator light is flashing, and the LINK indicator light is flickering or solid. If they are not, please read the FAQ.

⑥ Now you will be able to access the viewer software within the IP Speed Dome.

① Open Internet Explorer and type the IP address of 192.168.1.80 (default IP of the IP Speed Dome from the factory) into the Address Bar of the web browser (as seen below). Press Enter.



① If a message appears after pressing “Enter” similar to the image depicted below, choose “Try Again”. This message will vary depending on the operating system.

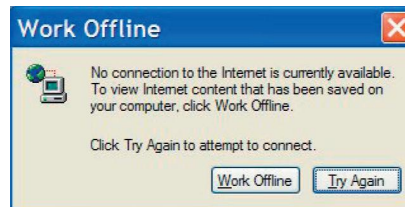

⑦ Now you will be able to see the login screen for the IP Speed Dome

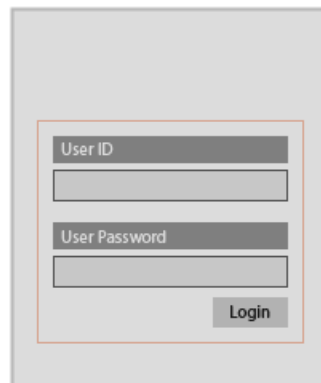

① The 3 authorities are available : Administrator, Operator and Viewer. The authority setup is available in Admin. Tools.

- Viewer Only monitoring is allowed.
- Operator Monitoring, PTZ Control and Digital In/Out Control are allowed.
- Administrator All functions are allowed.

-
- ⑧ The default ID and Password are both the word “admin” (without the “”)
 - ⑨ If at any time you are prompted to download ActiveX controls, you must click ‘Yes’, all content is safe.
 - ⑩ You will have to click “Yes” twice to two individual prompts. This allows your video to be displayed in Internet Explorer.

Guide to Network Setup

Please configure the IP Speed Dome at the location of its installation. You must determine your network scenario in order to configure the IP Speed Dome with the proper TCP/IP settings. This tutorial will guide you through the process. Before actually configuring the IP Speed Dome, determine what settings you will apply. Record those settings that you will use to configure your IP Speed Dome for reference.

When configuring your IP Speed Dome, treat the IP Speed Dome as another PC on your network. You will assign it several addresses and other TCP/IP properties to match your current network.

This step-by-step tutorial will teach what IP addresses and network configurations you should assign your IP Speed Dome based upon your network scenario.

- ① Before you begin, you will need to locate any information and settings that you have received from your Internet Service Provider (ISP). You may need to refer to these IP addresses at a later time during the configuration.
- ❶ If you were not given any IP addresses or the ISP was responsible for the setup and installation of your Internet connection on your PC or network, then please go to step ②
 - ❷ If you are not using a router on your network, your “Current TCP/IP Settings” (from the previous section) and “Assigned IP Addresses from My ISP” will be exactly the same

Assigned IP Address	
IP Address	
Subnet Mask	
Default Gateway	
Primary DNS Server	
Secondary DNS Server (Option)	

Static

Dynamic

PPPoE

- ② You must determine whether the IP address that you were assigned from the ISP is STATIC, DYNAMIC, or using PPPoE. At this moment, you are only concerned about the ISP. Did they provide you with a STATIC, DYNAMIC, or PPPoE address? If you are unsure, please contact your ISP.
- ③ Configure your IP Speed Dome’s TCP/IP settings for network connectivity by selecting Administration Tools from the main interface and selecting TCP/IP located on the left of the Administration Tools screen.
- ④ If prompted for an ID and Password, use “admin” for both entries.

The default web port number is 80. If your ISP blocks port 80 you must use a value between 1025-30000. Please consult your ISP and determine if they block TCP port 80.

- ⑤ Depicted below are several basic network scenarios. Determine which scenario describes your network. If your network does not match one of the scenarios below and are unsure how to setup your IP Speed Dome, please contact your network administrator, then call our Support Center.



Dash line box signifies areas of your network that you can't control. Only the ISP has access to these devices.

Case A : Dynamic IP or PPPoE + Personal Router [Most SOHO]

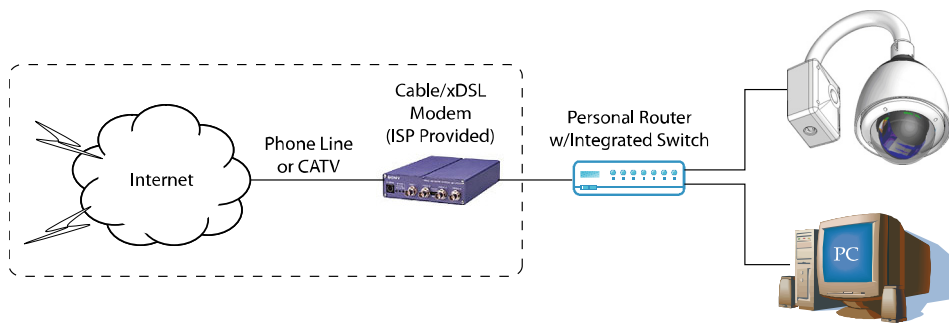

Configure your IP Speed Dome's TCP/IP properties as follows :

- Network Type
 - STATIC (even though you have Dynamic IP from your ISP, use STATIC on the IP Speed Dome)

- Internet Address
 - A private IP address such as 192.168.0.200 [Example]

① You need to assign the IP Speed Dome an IP address, just as you would assign a PC.

① The IP address you assign must be unique to your network as well as match your network. For information how to choose a unique IP and match your network please read the FAQ.

① The IP address you assign the IP Speed Dome must be a private IP. For information on how to chose a private IP please read the FAQ

- Subnet Mask
 - 255.255.255.0 [Example]

① You must use the same subnet mask as the one you noted under “Current TCP/IP Settings”

- Default Gateway
- 192.168.0.1 [Example]
- ① This IP address must be the IP address of your router (private or LAN side)
- ① Use the same Default Gateway you noted under “Current TCP/IP Settings”
- Primary DNS Server
- Use the 1st DNS Server from “Assigned IP Address from My ISP”
- ① If you did not receive any IP addresses from your ISP, please contact them and acquire the IP address of their DNS server.
- DDNS Server
- Use the DDNS server
- ① This is the same site you will register with later to accommodate dynamic IP from your ISP.
- Web Server Port
- 8888
- ① Do NOT use the default port 80, you must change this number.
- ① You may select any number between 1025 ~ 30000.
- Control Server Port
- 7777
- ① You may select any number between 1025 ~ 30000.
- Video Server Port
- 7778
- ① You may select any number between 1025 ~ 30000.
- Audio Transmit Server Port
- 7779
- ① You may select any number between 1025 ~ 30000.
- Audio Receive Server Port
- 7780
- ① You may select any number between 1025 ~ 30000.

Case B : Static(Fixed) IP + Personal Router [Efficient]

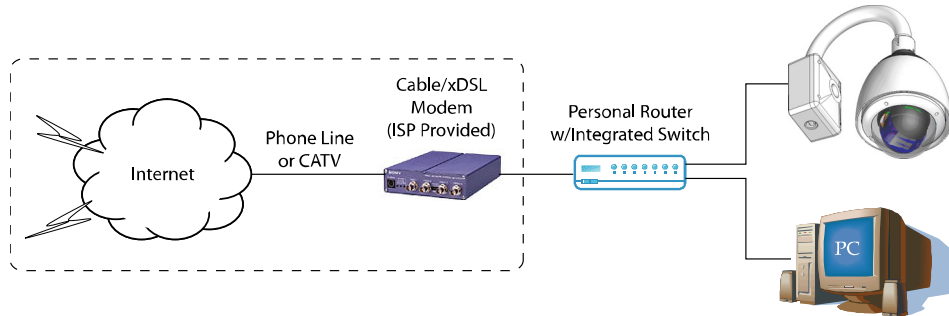

Configure your IP Speed Dome's TCP/IP properties as follows :

Network Type

• STATIC

Internet Address

• A private IP address such as 192.168.0.200 [Example]

- ① You need to assign the IP Speed Dome an IP address, just as you would assign a PC.
- ① The IP address you assign must be unique to your network as well as match your network. For information how to choose a unique IP and match your network please read the FAQ.
- ① The IP address you assign the IP Speed Dome must be a private IP. For information on how to chose a private IP please read the FAQ

Subnet Mask

• 255.255.255.0 [Example]

- ① You must use the same subnet mask as the one you noted under “Current TCP/IP Settings”

Default Gateway

• 192.168.0.1 [Example]

- ① This IP address must be the IP address of your router (private or LAN side)
- ① Use the same Default Gateway you noted under “Current TCP/IP Settings”

Primary DNS Server

• Use the 1st DNS Server from “Assigned IP Address from My ISP”

- ① If you did not receive any IP addresses from your ISP, please contact them and acquire the IP address of their DNS server.

DDNS Server

• Use the DDNS server

- ① This is the same site you will register with later to accommodate dynamic IP from your ISP.

Web Server Port • 8888

① Do NOT use the default port 80, you must change this number.

① You may select any number between 1025 ~ 30000.

Control Server Port • 7777

① You may select any number between 1025 ~ 30000.

Video Server Port • 7778

① You may select any number between 1025 ~ 30000.

Audio Transmit Server Port • 7779

① You may select any number between 1025 ~ 30000.

Audio Receive Server Port • 7780

① You may select any number between 1025 ~ 30000.

Case C : Static(Fixed) IP [Dedicated line directly to the IP Speed Dome]

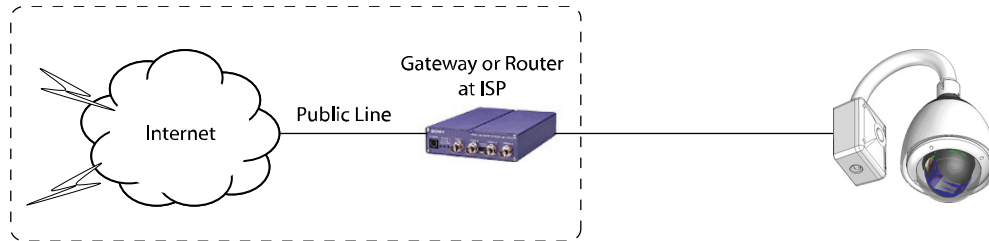

Configure your IP Speed Dome's TCP/IP properties as follows :

- Network Type

 - STATIC
- Internet Address

 - A static IP address received from your ISP, such as 24.107.88.125 [Example]

① You need to assign the IP Speed Dome an IP address, just as you would assign a PC.
- Subnet Mask

 - Subnet mask assigned from your ISP, such as 255.255.255.240 [Example]
- Default Gateway

 - 24.107.88.113 [Example]

① Use the assigned default gateway from your ISP
- Primary DNS Server

 - Use the 1st DNS Server from “Assigned IP Addresses from My ISP”

① If you did not receive any IP addresses from your ISP, please contact them and acquire the IP address of their DNS server.
- DDNS Server

 - Use the DDNS sever

① This is the same site you will register with later to utilize our DDNS service.
- Web Server Port

 - 80 [default]

① You may select any number between 1025 ~ 30000.
- Control Server Port

 - 7777

① You may select any number between 1025 ~ 30000.

Video Server Port • 7778

① You may select any number between 1025 ~ 30000.

Audio Transmit Server Port • 7779

① You may select any number between 1025 ~ 30000.

Audio Receive Server Port • 7780

① You may select any number between 1025 ~ 30000.

Case D : Dynamic IP + DSL/Cable Modem [Connected directly to the IP Speed Dome]

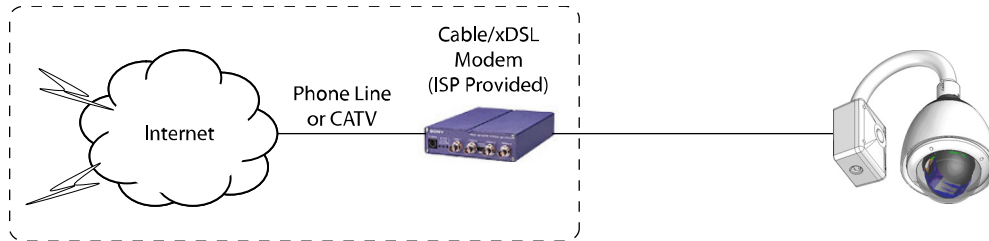

Configure your IP Speed Dome's TCP/IP properties as follows :

Network Type • DYNAMIC

DDNS Server • Use the DDNS server

① This is the same site you will register with later to accommodate dynamic IP from your ISP.

Web Server Port • 80 [default]

① You may select any number between 1025 ~ 30000.

Control Server Port • 7777

① You may select any number between 1025 ~ 30000.

Video Server Port • 7778

① You may select any number between 1025 ~ 30000.

Audio Transmit Server Port • 7779

① You may select any number between 1025 ~ 30000.

Audio Receive Server Port • 7780

① You may select any number between 1025 ~ 30000.

① When connecting the IP Speed Dome directly to a modem, power down and reset the modem. Leave the modem powered down until configurations are finalized with the IP Speed Dome and the IP Speed Dome has been correctly connected to the modem. Then power on the modem, followed by the IP Speed Dome.

Case E : PPPoE + DSL Modem [Connected directly to the IP Speed Dome]

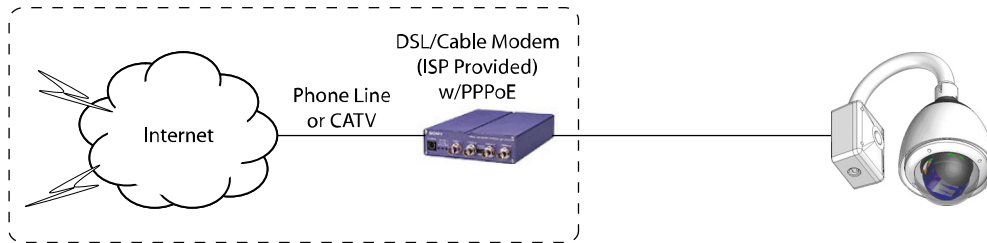

Configure your IP Speed Dome's TCP/IP properties as follows :

- Network Type • PPPoE
- User ID • Use the User ID or Username you received from your ISP for this direct connection
- User Password • Use the Password you received from your ISP for this direct connection
- DDNS Server • Use the DDNS server

i This is the same site you will register with later to utilize our DDNS service

- Web Server Port • 80 [default]

i You may select any number between 1025 ~ 30000.

- Control Server Port • 7777

i You may select any number between 1025 ~ 30000.

- Video Server Port • 7778

i You may select any number between 1025 ~ 30000.

- Audio Transmit Server Port • 7779

i You may select any number between 1025 ~ 30000.

- Audio Receive Server Port • 7780

i You may select any number between 1025 ~ 30000.



Port Forwarding

After entering the correct TCP/IP settings you will be ready for “Port Forwarding” (Cases A, B).

- Please record the TCP/IP settings of your IP Speed Dome for future reference. You may need this information to access your IP Speed Dome and to configure “Port Forwarding”.

IP Speed Dome TCP/IP Settings	
IP Address	
Subnet Mask	
Default Gateway	
Primary DNS Server	
DDNS Server	
Web Server Port	
Control Server Port	
Video Server Port	
Audio Transmit Server Port	
Audio Receive Server Port	

- After clicking “Apply” the system will prompt for a reboot. Please allow the system 50 seconds to reboot and accept the changes. After 50 seconds, close the configuration screen. The view will display “Trying to Reconnect”. If the ACTIVE light on the IP Speed Dome has gone off and is now back on again flashing, then the IP Speed Dome has rebooted. After the system reboots completely, remove the power supply from the unit and close Internet Explorer.**
- Return your PC/Laptop TCP/IP properties to their original settings.
- Before installing the IP Speed Dome, you must use “Port Forwarding” on your personal router (Cases A, B). You will need to forward 5 ports:
 - Web Server Port you assigned to the IP Speed Dome.
 - Control Server Port you assigned to the IP Speed Dome.
 - Video Server Port you assigned to the IP Speed Dome.
 - Audio Transmit Server Port you assigned to the IP Speed Dome.
 - Audio Receive Server Port you assigned to the IP Speed Dome.

Both of these ports will be forwarded to the IP address you assigned to the IP Speed Dome. In the example above, you would forward:

- 8888 → 192.168.0.200
- 7777 → 192.168.0.200
- 7778 → 192.168.0.200
- 7779 → 192.168.0.200
- 7780 → 192.168.0.200

① For information on how to use “Port Forwarding” please read Appendix C

Starting IP Speed Dome

After correctly forwarding the Web Server Port , Video Server Port, Control Server Port and two Audio Ports through your router (if applicable), you may then install the IP Speed Dome in a proper location.

- ① Locate the serial number located on the label attached to the bottom of the IP Speed Dome, you will need this for DDNS registration.
- ② Connect the IP Speed Dome to your router or cable/DSL modem (per your network scenario) via a Cat5/5e UTP Ethernet network cable.
- ③ Supply power to the IP Speed Dome.
- ④ After 50 seconds, verify the IP Speed Dome indicators:

• ACTIVE	Flashing
• LINK	Flickering/Solid
- ⑤ After configuring Port Forwarding on your router (if necessary), you may then access your IP Speed Dome on your local network by opening Internet Explorer and specifying the IP address and Web Server Port that you have assigned to the IP Speed Dome.

① Examples: <http://192.168.0.200:8888> or <http://24.106.88.123>

① if you left your Web Server Port set to 80, then you don't need to specify the port in the Address Bar when accessing the IP Speed Dome.

- ⑥ Access your IP Speed Dome via the Internet:
 - If you use Case B or C
 - i) Open Internet Explorer.
 - ii) Type the IP of the IP Speed Dome.
 - If you use Case A, D, E
 - i) Open Internet Explorer.
 - ii) Visit the DDNS website.
 - iii) Register the IP Speed Dome.
 - iv) Give the DDNS server 10 minutes (MAX) to locate your IP Speed Dome's IP information. You may reboot the server to send an immediate request to our DDNS server.
 - v) After your camera is connected, select your camera.

Web Viewer Screen

In this section, the main GUI of the IP Speed Dome will be explained.

General Tab

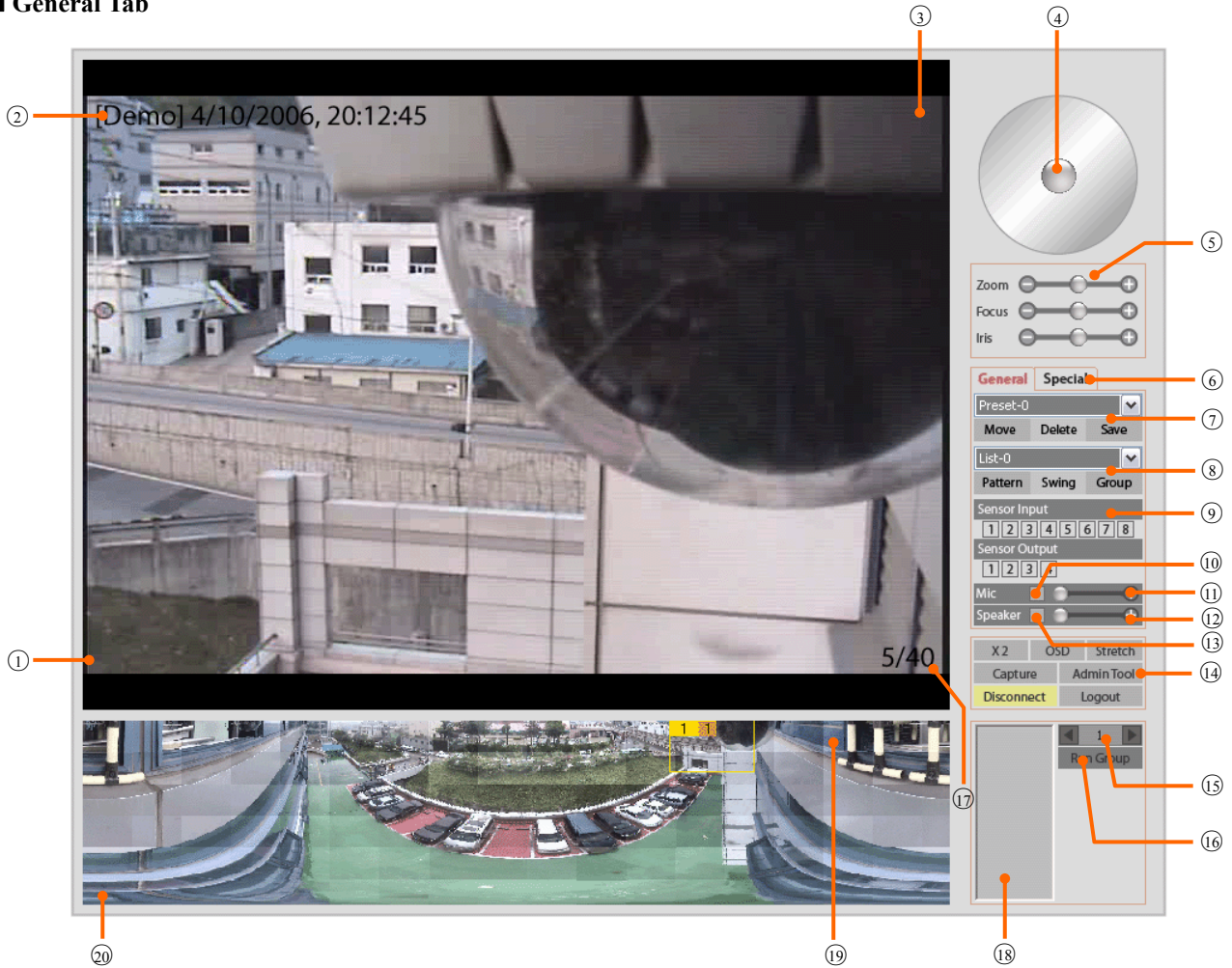

- ① Live video Display
- ② OSD - Camera Name / Date / Time
- ③ OSD – In this location, level of user logged will be displayed. For example, ‘G’ means guest level of user.
 - G = Guest User : Video monitoring only
- ④ Virtual Joystick Handle for Pan/Tilt control. If you press and drag the handle in the center of circle, the camera will be moved in accordance with your mouse movement. If you release the mouse button, camera will be stopped and the handle will be relocated to the center of the circle. It is noted that the speed will be proportional to the displacement of handle from the center.

- ⑤ Zoom, Focus, and Iris controls for the camera connected to IP Speed Dome. If you drag the each handle, Zoom, Focus, and Iris are adjusted individually according to your mouse motion.
- ⑥ Tap to switch General or Special function controls. The picture above shows controls when general controls are selected. If you select special tab, you will have more controls such as Map Create, Motion Detection, and Motion Tracking.
- ⑦ Controls for Presets memorized in the PTZ camera. It is noted that some PTZ devices may not support all of these functions and the Preset and Group functions created in the Map(⑬,⑭) are supported by IP Speed Dome.
- ⑧ Controls for Pattern, Scan and Group functions memorized in the PTZ camera. It is noted that some PTZ devices may not support all of these functions and the Preset and Group functions created in the Map is supported by IP Speed Dome.
- ⑨ Sensor Alarm Input status and Sensor Alarm Output control.
- ⑩ This button allows transmitting Audio stream from your MIC to IP Speed Dome.
- ⑪ Volume control for MIC in your computer.
- ⑫ Volume control for speaker out of your computer.
- ⑬ This button allows receiving Audio stream from IP Speed Dome.
- ⑭ Controls in this area has many functions such as;
 - X2 : 2 times Digital Zoom.
 - OSD : It means “On Screen Display”. Click this button to display the captions.
 - Stretch : Stretch will fit the video size to the viewer window regardless of resolution.
 - Capture : Click this button to save video as an image.
 - Admin Tool : Click this button to enter Administration Tools.
 - Connect/Disconnect : Click this button to disconnect or connect from the server.
 - Logout : Click this button to logout.
- ⑮ show the Current Group number. The maximum number of group is 20.
- ⑯ Click to run current group (shown in ⑮).
- ⑰ Display current number of users connected as:
[Current number of users connected / maximum number of users connected].
- ⑱ Show the list of presets selected in the group in ⑮.
- ⑲ Show the information of the preset stored before. The number in the yellow box is the preset number and the number in the orange box means Dwell time. It is noted that the box size means view size of corresponding preset. Accordingly, the smaller box size, the bigger zoom magnification.
- ⑳ This Screen is called map. This map data is normally stored in IP Speed Dome to share it with all clients. By pressing appropriate button, you may download it from IP Speed Dome or create to update it.

As explained before, there are three kinds of user authority level i.e. guest, operator and administrator and. It is noted that since the OSD display and Digital Zoom functions do not affect other users view but only affect the current view, these functions can be changed to all user levels. However, since all other functions affect to settings of the video server and accordingly video of all users connected, the user with administrator level can change those functions.

Special Tab

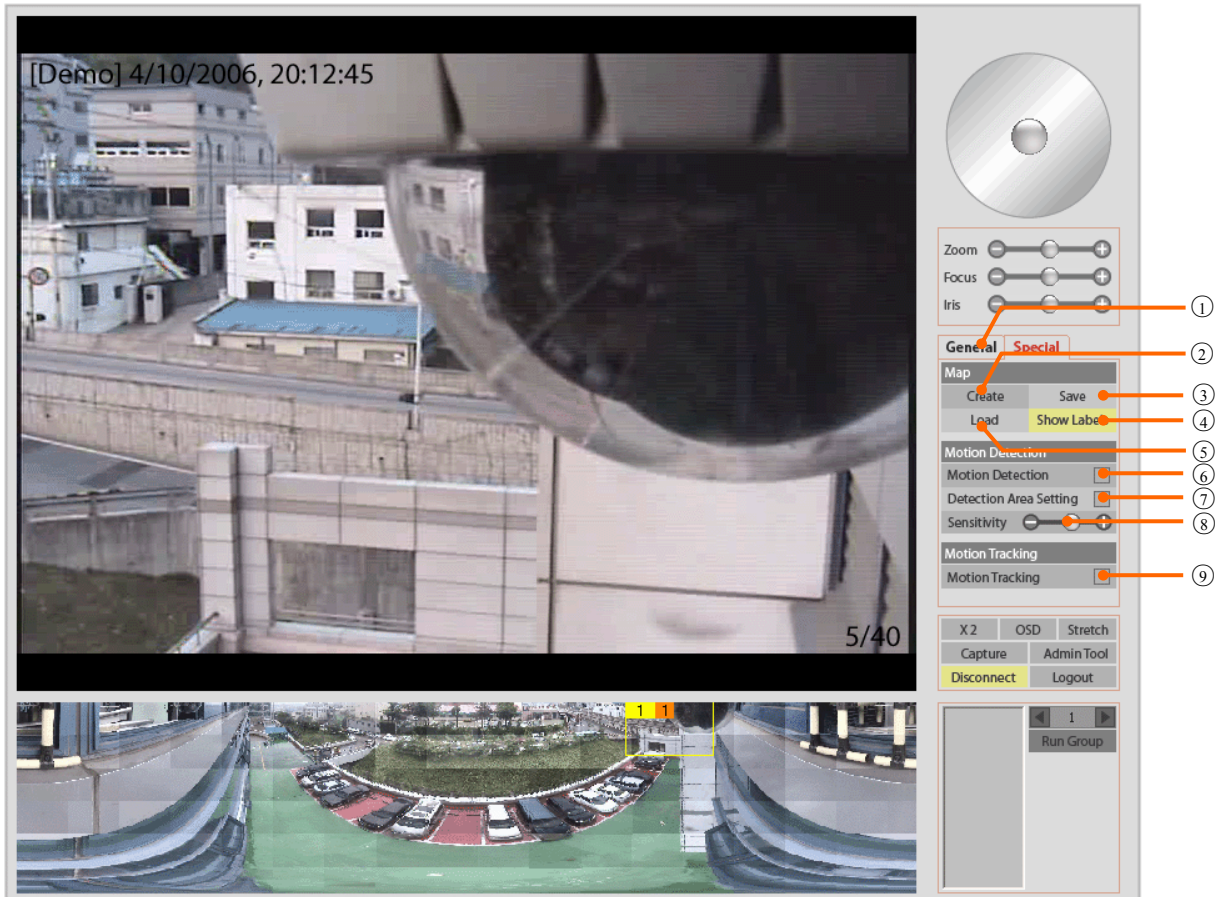

- ① Tab to switch General controls.
- ② Click it to create new map automatically. Before creating new map, please, make sure Camera model in the “Motion Tracking” menu and PTZ Protocol in “Control” menu in the Admin Tool is correctly selected.
- ③ Click it to store map, presets and group data to the IP Speed Dome.
- ④ Click it to show or hide the preset box and label on the map.
- ⑤ Click it to download the map from IP Speed Dome.
- ⑥ This button activates or stops motion detection. “Detection Area setting” bellow must be done in advance.

- ⑦ This button activates or stops motion detection target area setup mode.

[How to setup]

- (a) By clicking or dragging of mouse in the main view, you can create or erase the masks on the main view.
(b) Motion detection is effective in the “**Unmasked Area**”.
(c) Stop and save setting by clicking [Detection Area Setting] button.

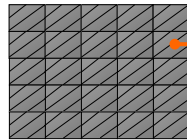

Masked Area
No detection

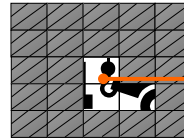

Unmasked Area
Effective detection

- ⑧ This defines the sensitivity of motion detection. Move small circular handle toward the + direction to increase the sensitivity.
⑨ Click it to turn Motion Tracking function on or off.

How does Motion Tracking work?

The “Motion Tracking (MT)” means intelligent moving object following using PTZ camera to get the best incoming information to figure out **behavior of moving target** in the **region of interest**.

Home Position: This is the location where camera waits for moving target object. If object is detected, MT starts from this point. To track object repeatedly, camera will return to Home when target is lost or out of range. A position where MT start button is pressed is set to be the Home position. It is recommended that the Gate or the main Entrance is a good candidate for Home position.

Region of interest: This region is defined by pan and tilt angle in Motion tracking menu in Admin tool. As show in the drawing, it confine the maximum range of MT activities. If MT reaches the limit, camera will return immediately. Otherwise, camera will follow other meaningless objects outside.

MT Procedures:

- (1) Wait at home till a moving target is detected.
The diction condition is defined by user in Motion Tracking menu.
- (2) Track a target by moving pan and tilt.
 - (2-1) Zoom out if target is too big. (Set the size in Motion Tracking Menu.)
 - (2-2) Zoom In if target is too small. (Set the size in Motion Tracking Menu.)
- (3) Zoom 1x if the target is lost. If no more movement are detected, return to home for next target.
- (4) Return to Home position if pan or tilt is out of range.

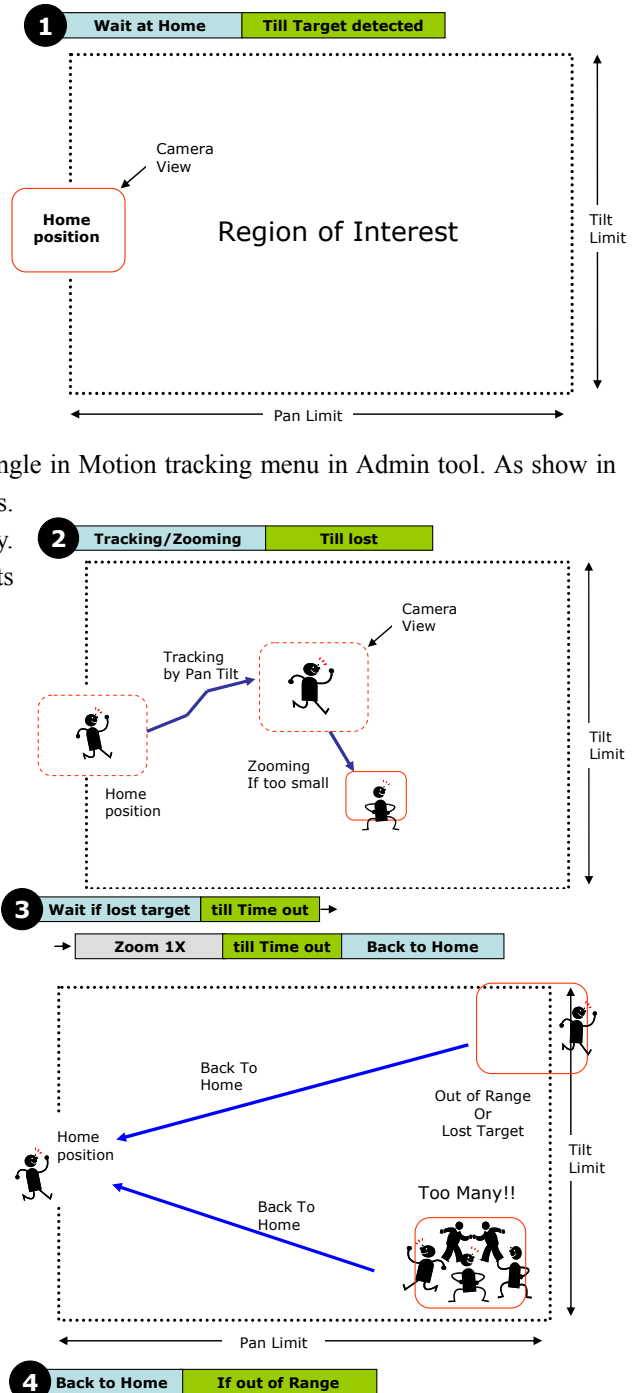

Priority Rule: Basically, if there are two moving objects crossing, MT will follow bigger sized object.



Rejection of Oscillating Objects: If there is an object oscillating limited distance like swaying tree, flag, MT will consider the distance and count number of oscillation. If the number exceeds the setting value in Motion tracking menu, it will return to home.

MT state diagram: The following state diagram will summarize most of actions explained above.

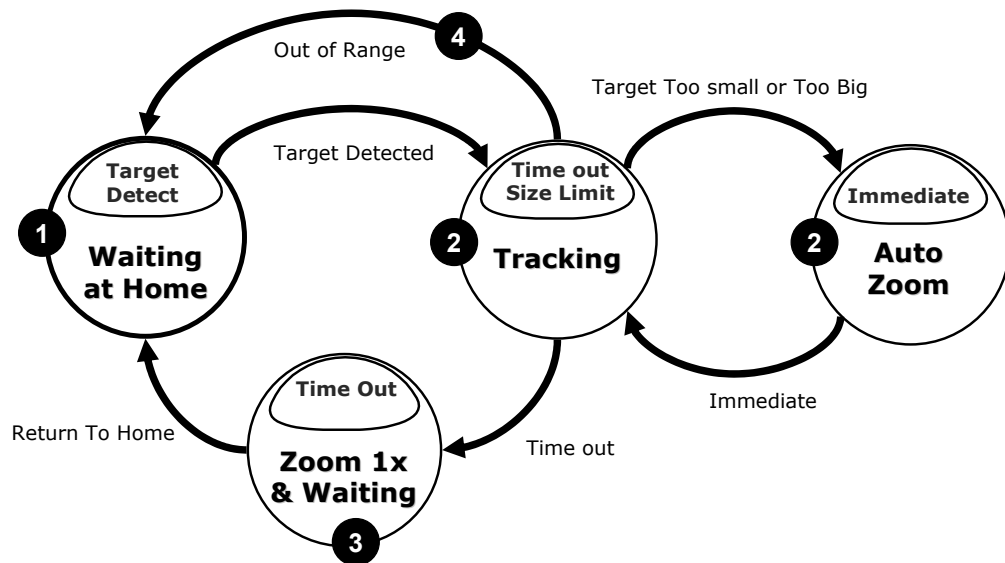

Create, Save, Load Map

Firstly, make sure Camera Model in “Motion Tracking” menu and PTZ Protocol in “Control” menu of Administration Tools before creating Map. Also, most map related function except “Load” can be operated only by the user who has Administrator authority.

Map	
Create	Save
Load	Show Labels

❑ Create Map

- (1) To make the most interested region be located in the center of Map, you have to move the camera to the target scene before new map is created.
- (2) Then, click the [Create] button to make IVS create new map automatically. Please wait for around 5 minutes till the color of Create button returns to grey. If you control something else when map is created, that will disturb creating work. As a result, you will have inaccurate and ugly map.

❑ Save Map

If you click [Save] button, the current Map, Preset and Group data will be uploaded to the IP Speed Dome. By this, you can use stored map data in the future and share it with other Clients.

❑ Load Map

If you click [Load] button, the Map, Preset and Group data stored previously will be downloaded from the IP Speed Dome.

If there is no map data stored in the IP Speed Dome, you will see only black map in the screen.

❑ Show Labels

Show or hide the preset box and label on the map.



Preset

If you draw a box on the map as shown in the picture bellow, the PTZ camera will move and change the zoom ratio to obtain the optimal video matched with the box you just draw.

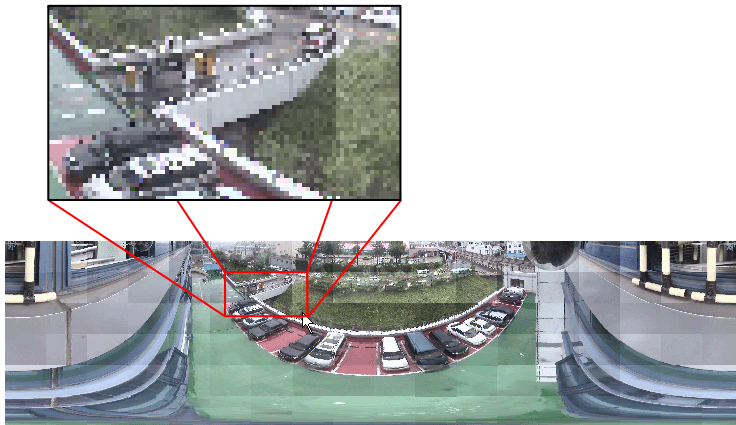

As shown bellow, if you click the right button of a mouse, you will see the menu item [Save Preset]. If you choose this, you will see a dialog box to specify Preset Number and Dwell Time. Dwell time means how long the camera will stay at corresponding Preset position while performing Group function. Dwell time can be a value 0 to 60 seconds.

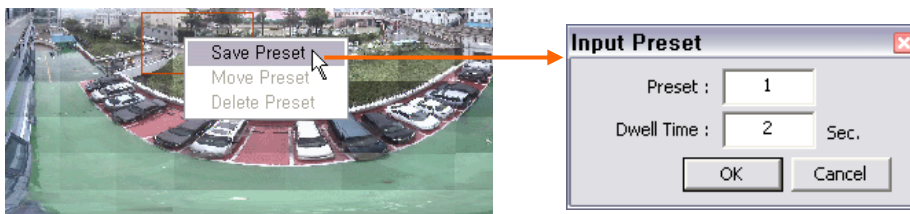

If you define a preset, size of view, location, number and dwell time of Preset is denoted on the map as shown in the pictures bellow. Moreover, the detail information of each Preset i.e. Pan / Tilt angle and zoom ratio will be displayed if the mouse approaches to yellow box.



If you click the preset number on yellow box or [Move Preset] menu shown with right click. Camera will move to corresponding preset view.

Group

If you drag a preset number in the yellow box on the map and drop it into the group list box as shown in the picture below, corresponding Preset number will be added and registered like "P000" as a member of Group. Maximum 20 presets can be member of one Group. Maximum 20 groups can be register in an IP Speed Dome.

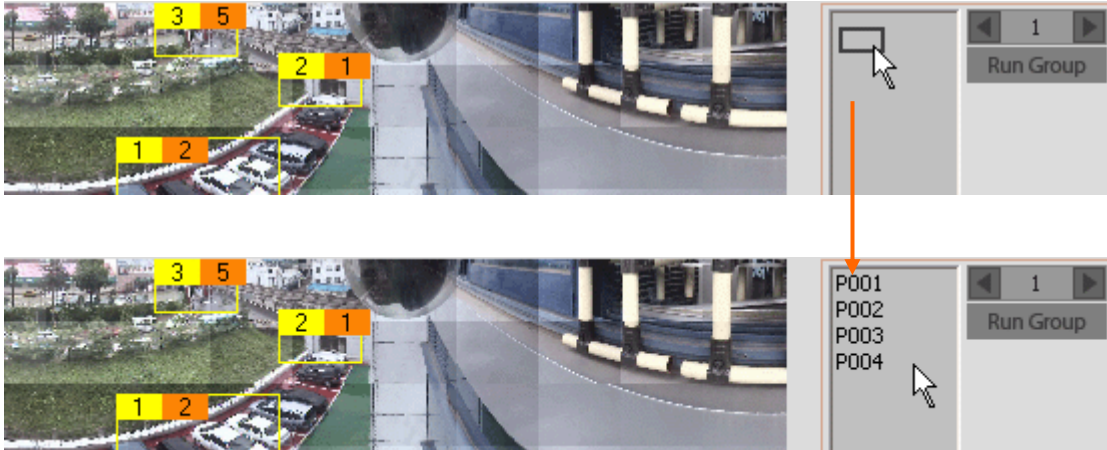

If you Click [Run Group], camera will move from a preset to other preset listed below repeatedly. If it arrive the last one, it will start from the beginning. It is noted that the interval will be determined by dwell time in the orange box and real moving time. To stop group operation, click [Run Group] button again.

To delete a group, select [Clear] menu showing if you click the right button on the Group list.



Viewer Interface

Click N Go

By clicking a target in main view, PTZ camera will move to locate the center of view to the target.

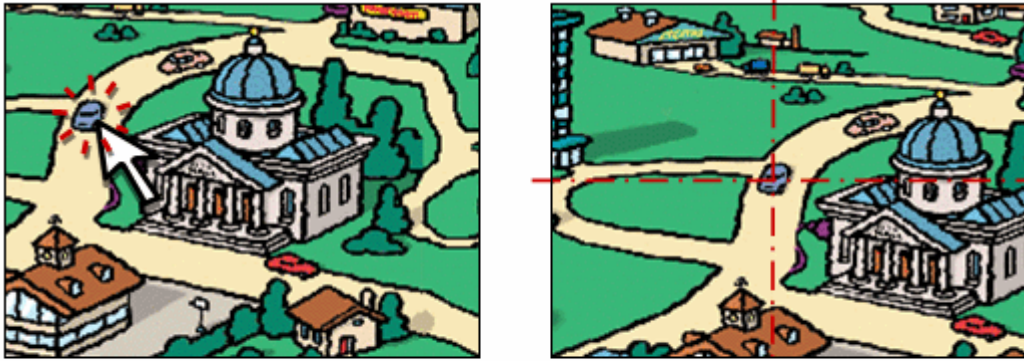

Box N Go

By drawing a box on the target in main view, PTZ camera will move the camera view to the center of the box and change zoom ratio to match the view size with that of the box surrounding the target.



This section is provided to familiarize the user with the administration tools. Intuitive options are not explained in detail.

All the changes on Administration Tools take effect immediately. These settings will be global, affecting the view of all users currently logged on. However, OSD items selections are effective only after you refresh the viewer windows or restart the internet Explorer.

All settings are always saved in the video server even when you close the viewer program or you turn off the Power of the video server. If you lost your password, you must press the reset button to return all setting to its factory defaults.

Video Tool

The screenshot shows the 'Video Tool' configuration interface. It is divided into four main sections:

- Camera:** Includes a text field for 'Camera Name' (set to 'CAM') and a group of checkboxes for 'OSD' settings: 'Camera Name' (checked), 'Date & Time' (checked), 'Function' (checked), 'Online Users' (checked), and 'Frame Rate' (unchecked). A note below states: '* These OSD settings are effective after the viewer window is refreshed or reloaded.'
- Appearance:** Includes a dropdown for 'Resolution' (set to 'D1 [720 X 480(576)]'), a dropdown for 'Frame Rate' (set to '30' FPS), and radio buttons for 'Camera Flip' (Normal selected, Flip unselected) and 'P/T Direction' (Normal selected, Reverse unselected).
- Encoding Parameters:** Includes radio buttons for 'Video Compression' (Motion JPEG unselected, MPEG-4 selected).
- Quality & BandWidth:** Includes radio buttons for 'Advanced Setting' (Simplified Setting selected, Advanced Setting unselected) and 'Encoding Video Mode' (Quality Basis selected, BandWidth Basis unselected). It also has dropdowns for 'Quality' (set to 'AAAA') and 'Bit Rate' (set to '30 Kbps').

- Camera Name** For easy identify the cameras, you can freely assign a name to the device or camera connected to the IP Speed Dome. This will change the camera name on OSD. (Maximum 7 characters available)
- OSD** Select OSD items displayed on the screen. This will effect only after refresh site or restart your internet explorer.
- Resolution** Select the resolution (or video size) of the viewer screen.

- Frame Rate Maximum frame rate of video to limit the traffic occupied.
- Camera Flip Flip the video orientation. (i.e. Turn the video upside down.)
- P/T Direction Define the direction of Pan/Tilt motion.
- Video Compression Choose the video compression method form Motion JPEG and MPEG-4 formats.
- Simplified Setting and Advanced Setting In fact, these two has same concepts. However, the **Simplified Setting** is described in terms of simple and easy expressions to help nonprofessional users.
If you are professional and want to set delicately, choose **Advanced Setting**.
- Encoding Video Mode In **Quality Basis mode**, you can select video encoding and streaming in the viewpoint of video quality rather than bandwidth occupied. In this case, Bandwidth can be traded off to meet your video quality requirement under some network environments. (This mode is same as VBR mode in Advanced setting)
In **Bandwidth Basis mode**, you can select video encoding and streaming in the viewpoint of Bandwidth rather than video quality displayed. In this case, quality can be traded off to meet your bandwidth requirement under some network environments. (This mode is same as CBR mode in Advanced setting)
- Quality This setting is available only Quality Basis mode. The quality level can be selected from 5 grades “A”, “AA”, “AAA”, “AAAA”, “AAAAA”. It is noted that if you select Advanced Setting mode, you can define more grades (1 ~ 31).
- Bit Rate This setting is available only Bandwidth Basis mode. The bandwidth can be select one of 10 values between 30Kbps to 5100Kbps. It is noted that you can select from more than 170 steps in Advanced Setting.

Control Tool

Serial Port Protocol

Com1 Devices : [PTZ Control]

Com2 Devices : [Auxiliary Device]

Com1 Port Setup

PTZ Camera ID : [0 ~ 255]

Baud Rate : Data Bit :

Stop Bit : Parity :

Use Advanced Communication Setting

Camera Pan Direction

Direction : CCW CW

- Com1 For PTZ devices only. Select the PTZ control protocol.
- Com2 For Digital I/O module only. Select the module type.
- PTZ Camera ID For PTZ Device Address Setup. 0 ~ 255 are available.
- Baudrate, Data Bit
Stop Bit, Parity Bit This setup is only for the non-standard protocols. Sometimes, PTZ protocol of some manufacturers requires communication settings different from those of the standard. To meet these special settings, click the check box of “**Use Advanced Communication Setting**” bellow.
- Use Advanced
Communication
Setting Used to adjust Baud Rate, Data Bit, Stop Bit, Parity Bit of the selected protocol. Do not use if the select protocol is standard.
- Camera Pan
Direction When the direction of camera pan is increasing clockwise, choose “CW”.
Other wise, choose “CCW”.

Motion Detection Tool

Detection Action

Alert Sound

Out 1 Out 2 Out 3 Out 4

- Detection Action** Set up the reaction of IP Speed Dome when motion detected.
- Alert Sound : Audio Out through the Audio out jack of IP Speed Dome.
- Out 1 ~ 4 : Select output relay numbers in the Sensor Alarm I/O module connected with IP Speed Dome.

Motion Tracking Tool

Camera & Display	
Camera Model	SONY 36x (Digital 12x)
Tracking Sensitivity & Range	
Tracking Sensitivity	4 [0 ~ 7, Default : 3]
Tracking Range	<input checked="" type="checkbox"/> ALL PAN 0 ~ 359 TILT 0 ~ 89
No Motion Timeout (% with respect to Screen size)	
No Motion Wait (>)	30 Sec. [0 ~ 255, Default : 15] Then 1X Zoom Out
1X Zoom Wait (>)	15 Sec. [0 ~ 255, Default : 30] Then return to Home
Escape from Oscillating Environment	
Oscillation Magnitude (<)	25 % [0 ~ 100, Default : 25] And,
Oscillation Count (>)	50 [0 ~ 100, Default : 50] Then return to Home
Object	
Object Size (<)	50 % [0 ~ 100, Default : 50] Then start to track
Object Size (<)	25 % [0 ~ 100, Default : 25] Then Zoom In
Object Size (>)	50 % [0 ~ 100, Default : 50] Then Zoom Out

- Camera Select model of Zoom Camera Module.
- Tracking Sensitivity Select the sensitivity 0~7 for target's movement during Motion Tracking. The bigger number, the more sensitive.
- Tracking Range Define the coverage of "Motion Tracking operation". If you want to apply motion tracking for all area, check the box before ALL. Otherwise, uncheck the box and specify the range of both Pan and tilt angles in degree. If the center of camera is out of effective range, the camera will return to its home position. This Range setting is very useful to exclude unwanted objects which is located some known area. For example, if your operating area has continuous moving objects such as liver, side walk or Free way which is not important for your application, you can assign effective area of motion tracking by setting both ranges of pan and tilt angle to exclude those area.
- No Motion Wait The time out of waiting during motion tacking state. If the moving object is occluded or out of view, camera will wait for a while. Otherwise, camera will be trapped forever. So, this value means timeout of waiting time. After this amount of wait time, camera will automatically zoom out to 1x to search the object lost.

- ❑ 1x Zoom Wait The time out of waiting after 1x zoom state. If camera loses a target object, it will automatically zoom out to 1x to search the object lost. If there is no moving object for a while, the camera will return to Home Position where “Motion Tracking” starts.
- ❑ Escape from Oscillating Environment If there are oscillating object which is swaying left / right or up/down with limited amplitude (like swaying tree), camera will be trapped to this object forever since camera can not tell whether it is real moving object or not. To escape from this kind of trap, we can assign escape conditions using two parameters i.e. Oscillation magnitude and count. If this condition is reached, the camera will return to Home to find out new moving object. **Oscillation magnitude** means percentage size of oscillation magnitude with respect to camera view size (this size is depending on zoom ratio). **Oscillation count** represents number of oscillation. To help understanding, let's assume oscillation magnitude is 10% and count is 50. If there is a leave swaying by wind continuously and its amplitude of oscillation is roughly under 10% with respect to view size of the camera, IP Speed Dome will count the number of oscillation till it reaches 50. Then, IP Speed Dome will ignore this object motion and make camera return to Home.
- ❑ Object Size There are 3 kinds of object size to be defined. To set up this easily, you must understand three characteristic of Motion tracking feature.
1. If size of moving object is too big, IP Speed Dome will ignore this object since it is likely to be noise, rain or Camera motion itself. In other words, IP Speed Dome will track the object smaller than size in the first box.
 2. If size of moving object is small, IP Speed Dome will send a command to increase the size by zooming in a little bit to see detail. In other words, IP Speed Dome will make camera zoom in if the object is smaller than size in the second box.
 3. If size of moving object is big, IP Speed Dome will send a command to reduce the size by zooming out a little bit not to lose the target. In other words, IP Speed Dome will make camera zoom out if the object is bigger than size in the third box.

TCP/IP Tool

Network Type

Static
 Dynamic
 PPPoE

IP Setup

IP Address :
 Subnet Mask :
 Default Gateway :
 Preferred DNS Server :
 Web Server Port : [Default : 80 Available Range : 1025 ~ 30000]
 Control Server Port : [Default : 7777 Available Range : 1025 ~ 30000]
 Video Server Port : [Default : 7778 Available Range : 1025 ~ 30000]
 Audio Transmit Server Port : [Default : 7779 Available Range : 1025 ~ 30000]
 Audio Receive Server Port : [Default : 7780 Available Range : 1025 ~ 30000]

- | | |
|---|--|
| <input type="checkbox"/> Network Type | Select a Static or Dynamic address scheme that is used by the Internet Service Provider (not the addressing scheme used by a personal router). |
| <input type="checkbox"/> Internet Address | Input a value to assign an IP address to the IP Speed Dome. |
| <input type="checkbox"/> Subnet Mask | Input a value to assign a subnet mask to the IP Speed Dome. |
| <input type="checkbox"/> Default Gateway | Input the IP address of the default gateway. |
| <input type="checkbox"/> Primary DNS Server | Input the IP address of an ISP's DNS server. |
| <input type="checkbox"/> Web Server Port | Assign a TCP port number to assign a Web Interface port number to the IP Speed Dome. This port is used for transmitting ActiveX program to web browser based viewer. |
| <input type="checkbox"/> Video Server Port | Assign a TCP port number to assign a Video Server port number to the IP Speed Dome. |
| <input type="checkbox"/> Control Server Port | Assign a port number for control server. This port is used for camera control. |
| <input type="checkbox"/> Audio Transmit Server Port | Assign Audio data send server port number. |
| <input type="checkbox"/> Audio Receive Server Port | Assign Audio data receive server port number. |
| <input type="checkbox"/> DDNS Server | Assign DDNS server address. |

DDNS Tool

DDNS Setup

Use DDNS

Primary DDNS Address :

Secondary DDNS Provider :

Host Name :

User Name :

User Password :

- | | |
|--|---|
| <input type="checkbox"/> Use DDNS | If you check this box, DDNS updating is enabled. (primary and secondary) |
| <input type="checkbox"/> Primary DDNS Address | Assign DDNS address. (default. www.net4c.net) |
| <input type="checkbox"/> Secondary DDNS Provider | Select DDNS Provider. Currently, DtDNS is available. |
| <input type="checkbox"/> Host Name | Type the host name registered in DDNS service (i.e. Host name in DtDNS) |
| <input type="checkbox"/> User Name | Type user name used for DDNS service (i.e. User Name(ID) registered in DtDNS) |
| <input type="checkbox"/> User Password | Type the password used for DDNS service (i.e. Password registered in DtDNS) |

SMTP Tool

This function is used to email the specified email recipient and notify that individual of the IP address / web port number used to access the IP Speed Dome. This email function is only activates on power-on reset time of IP Speed Dome.

E.Mail Server

SMTP Server :

User Name :

User Password :

Setting : Send E-Mail box SMTP Requires authentication

E.Mail Address

From :

To :

- SMTP Server Enter an SMTP server to send email.
- User Name Input user name used for SMTP authentication to access the mail server.
- User Password Input the password used for SMTP authentication to access the mail server.
- Send E-Mail box If this check box is set to on, email function is enabled.
- SMTP requires auth. Check this box if the mail server requires SMTP authentication.
- From Input the email address of sender. The email address should be admitted to the SMPT sever.
- To Input the email address of receiver.

Date & Time Tool

Current camera date & time

Date : 11/01/2007
Time : 14:41:52

New camera date & time

Synchronize with my computer time
Date : 11/01/2007
Time : 14:42:03

Set up manually
Date : [mm/dd/yyyy]
Time : [hh:mm:ss]

Synchronize with time server
Time Zone :
Time Server :

- Current Date/Time** It shows the current Date/Time setting of IP Speed Dome.
- New Date/Time** Select the method of Date/Time setting. Date/Time can be set by local computer or time server or manual.

Users Tool

System Manger

ID	Password	Verify	Auto Login
master	*****	*****	<input type="checkbox"/>

General Users

NO	ID	Authority	Auto Login
1	guest	Viewer	
2	admin	Operator	U

ID	Password	Verify	Authority	Auto Login
				<input type="checkbox"/>

Add Edit Delete Clear

- System Manager** Specify an ID and Password for the System Administrator of the IP Speed Dome. The System Administrator will have all rights and privileges to manage the system.

① After changing Administrator's ID and Password, IP Speed Dome should be booted to apply new ID and Password.
- General Manager** Give access privileges up to 40 separate user accounts.

① Only 40 users may be logged on simultaneously, regardless of what user identities are logged on.
- To add a user** Input an ID and Password, verify Password, select Authority, click ADD.
- To edit a user** Select the user from the list of users, make necessary changes, click EDIT.
- To delete a user** Select the user from the list of users, click DELETE.
- Operator Authority** This privilege gives the user rights to operate the PTZ controls.
- Viewer Authority** This privilege gives the user rights to operate only the icons associated with digital 2× zoom, stretch, OSD, and video capture. These options only affect that current user. The changes made there will have no effect on the other users logged on.
- Auto Login** Only one user/administrator may have Auto Login enabled. When the video server is accessed, it will bypass the login screen and logon automatically.

Firmware Update Tool

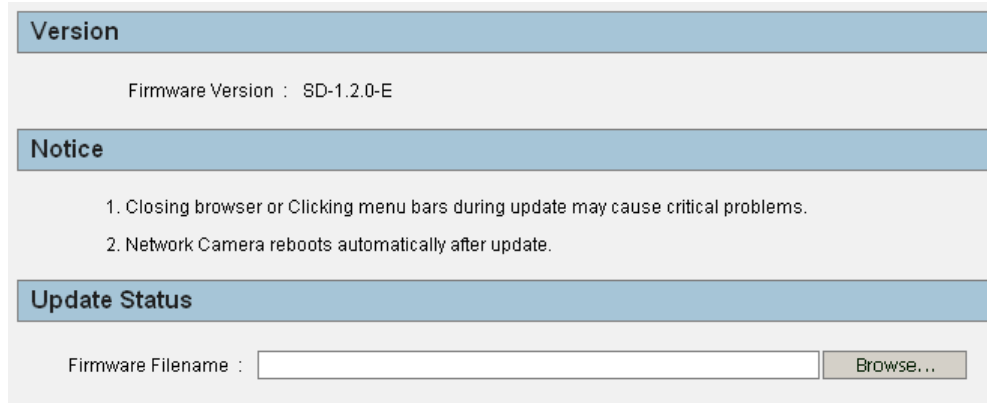

Version

Firmware Version : SD-1.2.0-E

Notice

1. Closing browser or Clicking menu bars during update may cause critical problems.
2. Network Camera reboots automatically after update.

Update Status

Firmware Filename :

- ❑ Version Shows the current firmware version.
- ❑ How to upgrade Click [Browse...] button and select the latest version of the firmware. Its file name should be *****.bin**.
Click [Update Start] button. It will start upgrading its firmware. IP Speed Dome will re-boot automatically as soon as it finish the upgrade process.

- ① **After upgrade, its system configuration should be set to factory default.**
- ① **Connect IP Speed Dome to a computer directly with a crossover Ethernet cable. Do not use internet to upgrade. There may be unexpected disconnection on internet during upgrade and it may cause fatal system damage.**
- ① **Do not close browser or click menu during update. It may cause fatal system damage.**

Default Set Tool

Reset its system configuration to the factory defaults.

Note) After initializing, all information should be deleted. Please re-consider before initializing.

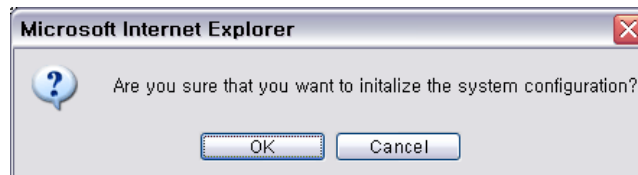

Rebooting Tool

Re-boots IP Speed Dome.

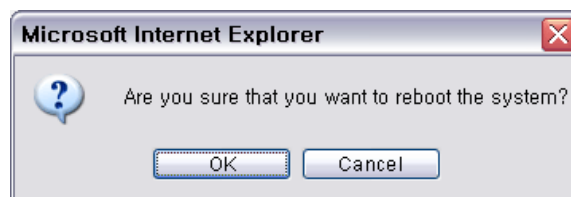

A : Current TCP/IP Settings

❑ For Windows 98 / ME Users

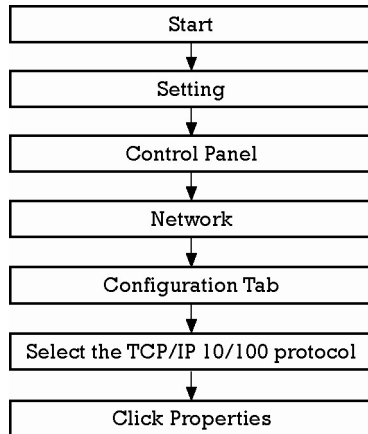

- Note the settings under the IP Address, DNS Configuration, and Gateway tabs

① If your IP settings are obtained automatically, you could use the MS-DOS prompt (or Command Prompt) to determine your IP address. For information on how to do this, please read the FAQ.

❑ For Windows 2000 or Windows XP

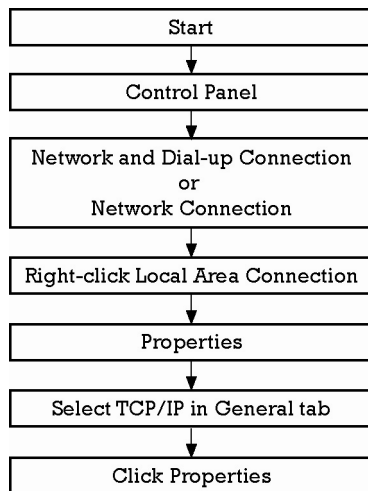

- Under the “General” tab of the TCP/IP Properties you will see your IP address information.

① If your IP settings are obtained automatically, you could use the MS-DOS prompt (or Command Prompt) to determine your IP address. For information on how to do this, please read the FAQ.

B : Changing your computer's IP address and subnet mask

- ❑ For Windows 98 / ME Users

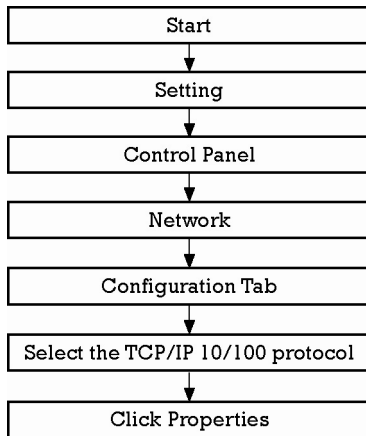

- Select 'Use the following IP address' and change the IP address and Subnet Mask.

- ❑ For Windows 2000 or Windows XP

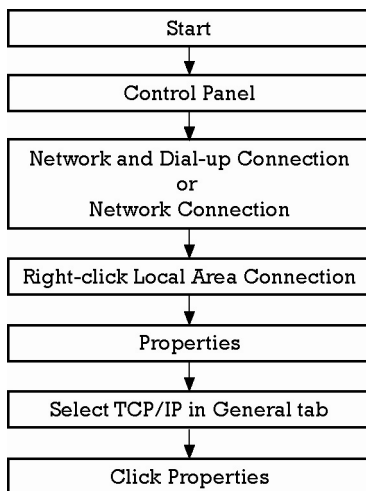

- Select 'Use the following IP address'

C : Port Forwarding

After assigning the IP Speed Dome a web server port and video server port you must use Port Forwarding (for cases A, B)

Please consult your router's user guide on how to correctly configure Port Forwarding.

For your convenience, we have provided two example configurations.

❑ For D-Link DI-604 broadband routers:

- ① Open a web browser and type http://192.168.0.1 into your Address bar. (the default IP address to access the router)
- ② You will have to supply your User Name and Password to log onto the router. Default from factory. (User Name: admin Password: [leave blank])
- ③ Select the advance tab and click "Virtual Server" menu.

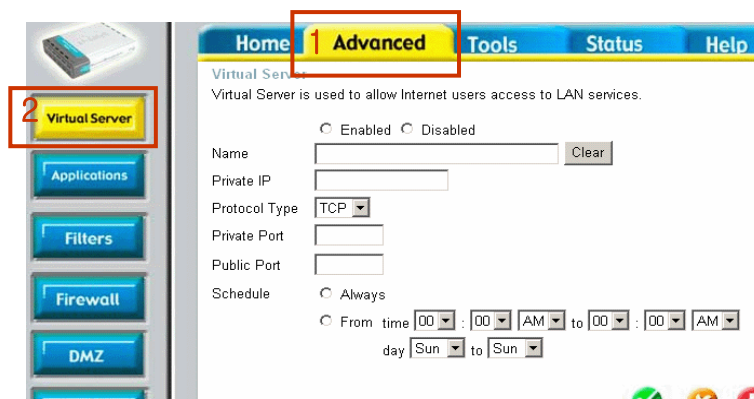

- ④ Click "Apply" button after inputting proper values. The example is as below

Enabled Disabled

Name

Private IP

Protocol Type

Private Port

Public Port

Schedule Always











From time : AM to : AM

day to

- Enabled / Disabled Select “Enabled”.
- Name Input IP Speed Dome name.
- Private IP Input IP Speed Dome address.
- Protocol Type Select “TCP”
- Private Port / Public Port Input IP Speed Dome Web Server Port.
- Schedule Select “Always”

- ⑤ If 'Setting Saved' shows, click [Continue] button.
- ⑥ With the same method as above, add Video Server Port and 2 Audio Ports.
- ⑦ The Web Server Port, Video Server Port and 2 Audio Ports shows in "Virtual Server List" as below.

Virtual Servers List

Name	Private IP	Protocol	Schedule	
<input checked="" type="checkbox"/> NVS_2	192.168.0.80	TCP 8080/8080	always	 
<input checked="" type="checkbox"/> NVS_2	192.168.0.80	TCP 7777/7777	always	 
<input checked="" type="checkbox"/> NVS_2	192.168.0.80	TCP 7778/7778	always	 
<input checked="" type="checkbox"/> NVS_2	192.168.0.80	TCP 7779/7779	always	 
<input checked="" type="checkbox"/> NVS_2	192.168.0.80	TCP 7780/7780	always	 

❑ **For Linksys BEFSR41 Cable/DSL routers:**

- ① Open a web browser and type http://192.168.1.1 into your Address bar (the default IP address to access the router)
- ② You will have to supply your User Name and Password to log onto the router. Default from factory (User Name:[leave blank] Password: admin)
- ③ Select Applications & Gaming from the menu bar.

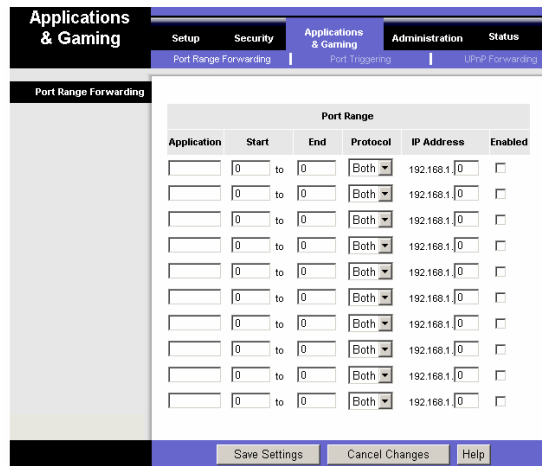

- ④ Input port numbers in "Port Range" as below and click [Save Setting] button. Both of Web Server Port and Video Server Port should be added. The example is as below.

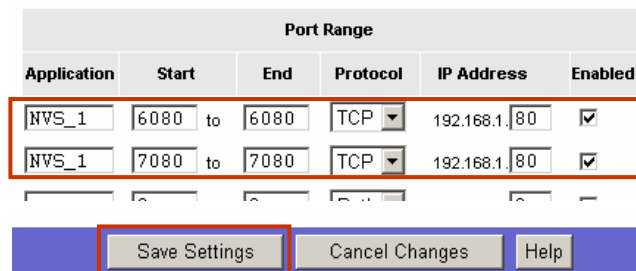

- Application Input IP Speed Dome name.
- Start / End Input IP Speed Dome Web Server Port and Video Server Port.
Start should be same as End.
Both of Web Server Port and Video Server Port should be added.
- Protocol Select "TCP" in Protocol option.
- IP Address Input IP Speed Dome IP Address.
- Enabled Check the square.

❑ For Netgear RP614 routers

- ① Input <http://192.168.0.1> in address bar of web browser. <http://192.168.0.1> is the default IP address.
- ② If it asks ID and password, input [admin](#) as ID and [password](#) as password.
- ③ Click "Port Forwarding" in "Advanced".
- ④ Click "Add Custom Service" button in Port Forwarding page.

Port Forwarding

Service Name: SERVICES Server IP Address: 192 . 168 . 0 . Add

#	Enable	Service Name	Start Port	End Port	Server IP Address
	<input type="checkbox"/>				

Add Custom Service Edit Service Delete Service

Apply Cancel

- ⑤ Input proper values in "Ports - Custom Services" page as below.

Ports - Custom Services

Enable

Service Name:

Starting Port: (1~65535)

Ending Port: (1~65535)

Server IP Address: 192 . 168 . 0 .

Add Cancel

- Enable Check it.
- Service Name Input IP Speed Dome name.
- Starting/Ending Port Input IP Speed Dome Web Server port. Starting Port should be same as Ending Port.
- Server IP Address Input IP Speed Dome IP Address.

- ⑥ Click "Add" button.
- ⑦ With the same method as above, add Video Server Port.
- ⑧ Click "Apply" button to finish Port Forwarding.

❑ I can't connect!!

In the case of a connection failure.

Modem Reboot > Modem Reboot Finished > Router Reboot > Router Reboot Finished > IP Speed Dome Reboot > IP Speed Dome Reboot Finish > Verify DDNS and IP Speed Dome connection, if applicable.

❑ How do I choose a unique IP address that matches my network?

For your home or small office, ensure that all devices on your network are running. PING an IP address that you plan to assign to the IP Speed Dome. If you receive a "Request timed out", then you may use that IP address. To ensure the IP address that you will assign the IP Speed Dome matches your network, review your "Current TCP/IP Settings" that you had recorded earlier. See some examples below:

- If your "IP Address" entry in "Current TCP/IP Settings" was 192.168.0.y, and your "Subnet Mask" was 255.255.255.0 then use 192.168.0.x for your IP Speed Dome's IP Address ("x" meaning any number between 2-254 that you wish, as long as it passes the "PING" test).
- If your "IP Address" entry is not a 192.168.z.y address with a "Subnet Mask" of 255.255.255.0 then please contact our Support Center.
- If your "IP Address" entry is not a 192.168.z.y address, please contact our Support Center.

❑ How do I open an MS-DOS or Command Prompt?

- Windows 98 / ME Users : Start → Programs → Accessories → MS-DOS prompt
- Windows 2000 / XP Users: Start → (All) Programs → Accessories → Command Prompt

❑ How do I "PING" an IP address?

- ① Open an MS-DOS (or Command) prompt
- ② At the prompt type - "ping xxx.xxx.xxx.xxx" (without the quotes and replace the "x"s with an IP address)
- ③ Press Enter

❑ How do I enable or check ActiveX on my browser

Open Internet Explorer → Tools on the menu bar → Internet Options → Security Tab → Custom Level → Scroll down and verify that you are prompted or have enabled ActiveX controls and plug-ins to be downloaded and executed. → click OK → restart browser

❑ How do I find out my IP address information if my settings were automatically detected?

- Windows 98 / ME Users
 - ① Open an MS-DOS Prompt
 - ② At the prompt type: “winipcfg” (without the quotation marks)
 - ③ Use the drop down list to select your 10/100 Ethernet Adapter (not a PPP adapter)
 - ④ Now you will see your IP Address, Subnet Mask, and Default Gateway information
 - ⑤ For DNS information contact your Internet Service Provider
- Windows 2000 / XP Users
 - ① Open a Command Prompt
 - ② At the prompt type - “ipconfig /all” (without the quotes)
 - ③ Near the end of the information supplied, should be your current IP address, subnet mask, default gateway and DNS servers

❑ How do I choose a private IP address:

Assign your IP Speed Dome a private IP address that matches your current network. Below lists the ranges for private addresses:

- Private Class A address space : 192.168.0.0 - 192.168.255.255
- Private Class B address space : 172.16.0.0 - 172.31.255.255
- Private Class C address space : 10.0.0.0 - 10.255.255.255

❑ My POWER light is not on?

Power is not being supplied to the unit. Please use the power supply shipped with the unit and verify that a power source is active from the attached power outlet used to connect the adapter. You can test this by plugging in any other electrical device and verify its operation. After using the power supply shipped with the product, checking the power source, and reinserting the power connector into the IP Speed Dome, please call our Support Center. The power supply may be defective.

❑ My ACTIVE light is not flashing?

Verify the power supply to the unit. Power off the unit and back on again, wait 1 minute, if the ACTIVE light still does not begin to flash, you will have to set the unit to its factory default (THIS WILL DELETE ANY CONFIGURATION AND SET THE UNIT TO THE FACTORY DEFAULTS). Power on the unit and insert the end of a paper clip into the small recessed opening on the back of the unit. Use the clip to press the button located within that opening.

❑ **My LINK light is not flashing or solid?**

Verify the cable connection. 99% of the time the cable's connection to the unit is causing this problem. Try using a different network cable or crossover cable (for PC connection only). Try reinserting the cable, if this still doesn't solve the problem call our Support Center.

❑ **I want to prevent users from viewing my camera.**

- ① Go into Administration Tools of the IP Speed Dome.
- ② Click on Users
- ③ Delete the user or all users by deleting the ID and password associated with that user.

❑ **Can I record the video?**

Yes you can record, but you will need to purchase a separate software program to allow PC-based recording. This software is available by contacting your distributor or our Customer Service Center. The software named "I-PRO" will connect up to 16 separate 1-channel video servers for remote viewing, remote controlling, and remote recording without the loss of quality or size (up to 640×480 resolution).

❑ **I can access the video server on my LAN, but not from the Internet.**

Verify that your router (if applicable) has port forwarding properly configured. If accessing from our DDNS service, verify correct serial number. Firewall issues may prevent user access.

❑ **How do I reset the unit to factory defaults?**

On the underside of the unit you will find a recessed opening located near the top-left side of the label. Power ON the unit and use a paper clip to push the reset button within that opening. You should then see the ACTIVE light turn off and after a few seconds the ACTIVE light will begin to flash, signifying a successful reboot. If the ACTIVE light does not turn off after depressing the reset button, please try holding the button in for a few seconds and releasing. **YOU WILL LOSE ALL DATA THAT HAD BEEN ENTERED PREVIOUSLY AND THE IP SPEED DOME WILL BE SET TO ITS FACTORY RESETS.**

❑ **Can I use the IP Speed Dome on my dial-up Internet connection?**

No, we recommend a high-speed broadband connection of at least 128Kb/sec.

❑ **I'm accessing my video server remotely over the Internet and the video stream is choppy, is this normal?**

Yes. The frames per second received remotely are determined by your bandwidth capabilities both at your site where the IP Speed Dome is installed and your remote location. The lower of the two sites will determine how fast your video stream is received. It is recommended to have at least a 256Kb/sec upstream connection from the site where the IP Speed Dome is installed. Lower speeds will operate properly, but provide poor remote performance. The Faster the Internet connection at both ends, the faster the video stream.

❑ **Can I view multiple cameras at once?**

Currently the IP Speed Dome supports 1 channel of video input. Typically, one camera per IP Speed Dome.

You can view multiple cameras only if the IP Speed Dome is connected to another device supporting multiple cameras (DVR, multiplexer, etc.) or if you purchase the I-PRO II software which will connect up to 16 separate IP Speed Dome, each connected to their own camera or device.



Specifications

Camera	Sensor	1/4" interline EX-View ccd
	Max.Pixels	N:811(H)x508(V)410K, P795(H)x596(V)470K
	Effective Pixels	N:768(H)x494(V)380K, P752(H)x582(V)440K
	Horizontal Res.	520~540TVL
	S/N Ratio	More than 50db
	Zoom	18x Optical Zoom, 12x Digital Zoom 36x Optical Zoom, 12x Digital Zoom
	Focal Length	18times :F1.4(w)3.0(T) f=4.1~73.80mm 36times: F1.4(w)3.0(T) f=3.4~122.4mm
	Min. illumination	0.01Lux(ICR on)
	Day & Night	Auto
	Focus	Auto/Manual
	Iris	Auto/Manual
	White Balance	Auto/ATW/Indoor/Outdoor
Backlight	On/Off	
Pan/Tilt	Range	Pan 360 ° (Endless) /Tilt 90 °
	Pan/Tilt Speed	Max.Preset Speed: 360 °/sec.
		Manual: 0.05 °~ 180 ° /sec(proportional to zoom)
		Max.Preset Speed: 380 ° /sec.
		Swing: 20 ° ~ 60 ° /sec.
	Preset	127 Preset (with editable labels)
	Pattern	4 Pattern(1 min/Pattern)
Swing	8 Swing	
Group	8 Group(20 action entities per Group)	
General	Communication	RS-485 (Max.255 unit)
	Protocol	Pelco-D, Pelco-P selection
	Alarm I/O	8 input/4 output
	Fan/Heater	Built in
	Rated Power	AC24V /1.5A
	Dimension	Dome: 152mm, Housing: 214x260(H)mm
	Net Weight	Approx 2.5 Kg
	Operating Temp.	-30 °C ~ 50°C

Network	CPU	32Bit RISC Processor
	OS	Embedded Linux
	Flash Memory	8MB
	Network	10/100 Base-T Ethernet (RJ-45)
	Compression	Selectable MJPEG and MPEG-4 ASP Level 5
	Frame Rate	30 @ 720×480 : 25 @ 720×576
	Audio	Bidirectional/ ADPCM
	Video Streaming	CBR, VBR, Adjustable Bit Rate
	Number of Users	Max. 40 Simultaneously

[Web Viewer]



Dimension & Options

Options

- Ceiling Mount bracket
- pole mount bracket
- corner mount bracket

** wall mount included

