

ADVANCED MPEG4 DVR

Digital Video Recorder

4 Channel, 8 channel and 16 channel Models

VER 1.1



The most stable and reliable stand-alone Digital Video Recorder

INSTALLATION & SAFEGUARDS

All the safety and operating instructions should be read before operation.

Environment Condition for Installation

1. To prevent electric shock or other hazard, do not expose this unit to rain, moisture, or dust.
2. Place this unit in a well-ventilated place and do not place heat-generating objects on this unit.
3. This unit should not be located in an area where it is likely to be subjected to mechanical shocks.

Before You Start



1. Ensure the power switch is in the OFF position prior to installation.
2. Opening or removing the cover may expose you to dangerous voltage or other hazards.
3. Operate this unit within the range of room temperature and humidity.
4. Supply power through the type of power source indicated on the manufacturer's label and with the power supply included in this unit.
5. Keep this unit out of direct sunlight and heat .
6. Make sure conductive material does not go into the fan hole.

Notice



1. Before initial configuration or operation, first set TIME/DATE, and then set this unit to the FACTORY DEFAULT setting, and lastly HDD clear. Follow these steps in order. Otherwise it may cause non-recording on the HDD or non saving setting value. Or it may record, but you will not be able to search recorded data.
2. This unit is compatible with large sized HDD.
3. When setting RECORDING SETUP after installation, set not only RECORD CONFIGURATION, but also SCHEDULE SETUP. Setting Schedule setup is necessary as this unit records according to Record type & Schedule setup. Default setting value for Schedule setup is Continuous mode.
4. Stop recording before powering off this unit by entering setup menu. Powering off while recording may cause critical malfunctions such as Recording Error, Playback Error, or System Error.

FCC Information



This equipment has been tested and found to comply with the limits for a Class A digital device, pursuant to part 15 of the FCC Rules.

These limits are designed to provide reasonable protection against harmful interference when the equipment is operated in a commercial environment.

This equipment generates, uses, and can radiate radio frequency energy and, if not installed and used in accordance with the instruction manual, may cause harmful interference to radio communications.

Operation of this equipment in a residential area is likely to cause harmful interference in which case the user will be required to correct the interference at his own expense.

Changes or modifications not expressly approved by the party responsible for compliance could void the user's authority to operated the equipment under FCC rules.

Table of Contents

CHAP. 1	Features and Package Contents	-----	5
1-1.	Features	-----	5
1-2.	Package Contents & Description	-----	6
CHAP. 2	Function of Buttons	-----	7
2-1.	Front Panel	-----	7
2-2.	Rear Panel	-----	9
2-3.	Connector Pin	-----	11
CHAP. 3	Installation	-----	13
3-1.	Configuration	-----	13
3-2.	Detailed Configuration	-----	14
CHAP. 4	Display Configuration	-----	19
4-1.	Current Status	-----	20
4-2.	Display Status	-----	20
4-3.	Popup Menu	-----	21
4-4.	Toolbar	-----	25
CHAP. 5	DVR Setup	-----	26
5-1.	Operation	-----	26
5-2.	Display	-----	30
5-3.	Record	-----	37
5-4.	Event	-----	44
5-5.	Network	-----	50
5-6.	System	-----	54
CHAP. 6	Search	-----	62
6-1.	Calendar Search	-----	62
6-2.	Event Search	-----	64
6-3.	Bookmark Search	-----	66

CHAP. 7	DVR Operation	-----	67
7-1.	Live Monitoring	-----	67
7-2.	Event Monitoring	-----	71
7-3.	Mouse Operation	-----	72
7-4.	Record	-----	73
7-5.	Audio	-----	73
7-6.	Search	-----	73
7-7.	Playback	-----	76
7-8.	Network Setup	-----	78
CHAP. 8	Integrated Remote Station	-----	89
8-1.	IRS Setup	-----	89
8-2.	IRS Operation	-----	91
8-3.	Remote Viewer	-----	94
8-4.	Search	-----	95
8-5.	Backup	-----	98
8-6.	Player	-----	101
Appendix A	Frequently Asked Questions	-----	104
Appendix B	Factory Default Value	-----	105
Appendix C	Specification & Dimension	-----	112
Appendix D	Remote Control	-----	114

CHAPTER 1. Features and Package Contents

1-1. Features

Live Display

PIP (Picture in picture), Freeze, Zoom, Sequence, PTZ function

1/4/6/8/9/13/16 Split display

Record

Image quality setup in 4 steps

Schedule recording / Holiday setup

Event record by alarm and motion detection

Panic recording

Video Loss detection

BOOKMARK function

4ch Audio record

Pre-Event recording

Network

Monitoring, Setup, Search & Backup

DDNS support

E-mail notification

Playback

Easy search and playback by Date/Time, Event, Bookmark

Various playback speed (forward/reverse)

Data Backup

Data import/export via USB

Backup via USB or CD/DVD-RW

Network backup

Others

Simple and easy menu control with popup menu via mouse control

Multi-Language (English, French, German, Spanish, Italian)

Password lock

NTSC/PAL auto detection

Remote control

SPOT monitor

Video loss detection

1-2. Package contents & Description

1. DVR Main Unit

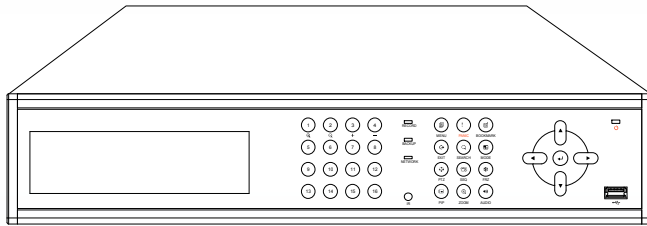

2. Remote Control

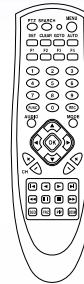

3. Power Cable

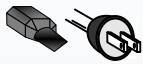

4. Power Adapter

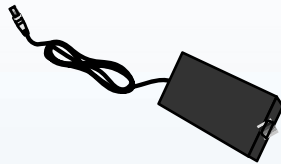

5. User's Manual

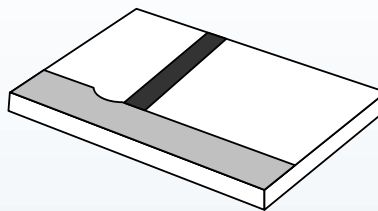

6. Software CD



7. Rubber Pad

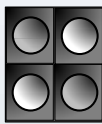

8. HDD Absorber

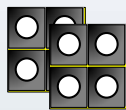

9. Batteries



10. Rack Mount Bracket / HDD Bolts

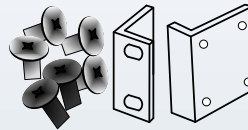

11. Mouse



Contents	Description
1. DVR Main Unit	Stand-Alone Digital Video Recorder
2. Remote Control	Remote Control
3. Power Cable	AC power supply to adapter
4. Power Adapter	DC power supply
5. User's Manual	User's Manual
6. Software CD	IRS (Integrated Remote Station) Software
7. Rubber Pad	Prevent DVR from slipping by attaching on the bottom of the unit
8. HDD Absorber	Absorbing the mechanical shock of HDD against the case bottom
9. Batteries	Batteries for Remote Control
10. Rack Mount Bracket / Bolts	Rack Mount Bracket / 6 Bolts for fixing Rack Mount Bracket to DVR / 4 Bolts for fixing DVR with Rack Mount Bracket to 19" Rack / 8 Bolts for fixing HDD into DVR
11. Mouse	DVR function control

CHAPTER 2. FUNCTION BUTTONS

2-1. Front Panel

[4 Channel Front]

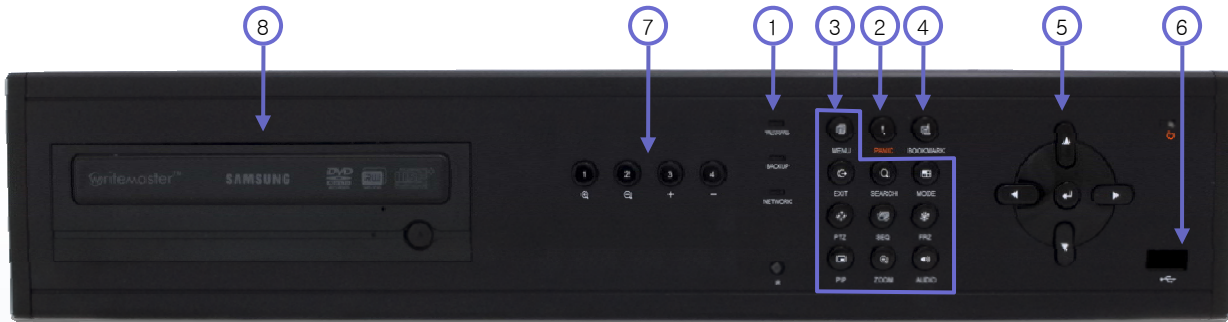

[8 Channel Front]

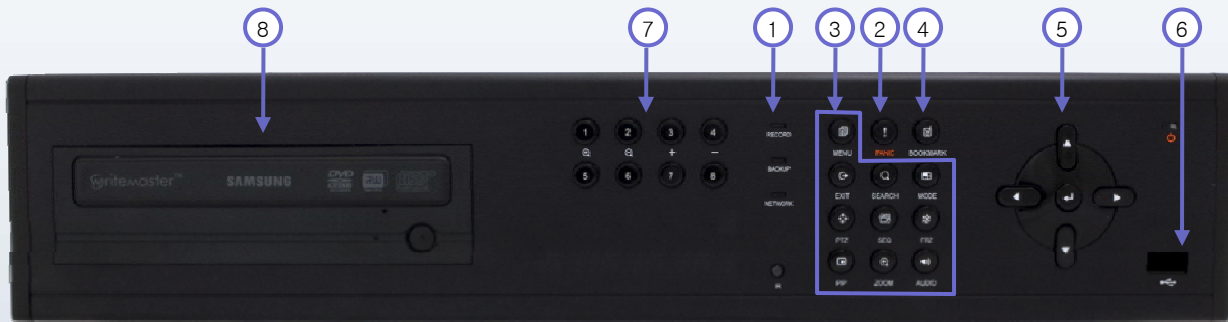

[16 Channel Front]



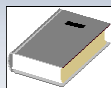

<Note>

This manual covers the 4 channel, 8 channel and 16 channel digital video recorders. For simplicity, the illustrations and descriptions in this manual refer to the 16 channel model.

NO	Name	Function	
1	LED	Indicating operation status	
2	PANIC	Emergency recording	
3	Function Key	EXIT	Stop for panic recording & playback, return to schedule recording, cancel to select function key
		MENU	Enter SYSTEM MENU or for powering off the unit
		MODE	Switch screen division from full screen to 16 split screen (in 1, 4, 9 sequence)
		SEARCH	Search recorded data on HDD
		AUDIO	Select audio channel.
		PTZ	Switch LIVE mode to PTZ control mode
		SEQ	Auto camera image sequence in full screen mode
		FRZ	Freeze live image
		PIP	Picture In Picture mode
		ZOOM	Zoom image
4	BOOKMARK	Bookmark	
5	Direction Key	Navigate in the menu (while playback)	
		FRZ	PAUSE
		LEFT	Reverse playback
		RIGHT	Playback
		UP	Increase playback speed
		DOWN	Decrease playback speed
6	USB Port	For recorded data backup and firmware upgrade	
7	Camera Selection / PTZ Control	1~16 Button : Select camera channel in full screen mode	
		1, +	ZOOM IN
		2, -	ZOOM OUT
		3, +	Focus Far
		4, -	Focus Near
8	CD/DVD-RW	For recorded data backup	

2-2. Rear Panel

[4 Channel Rear]

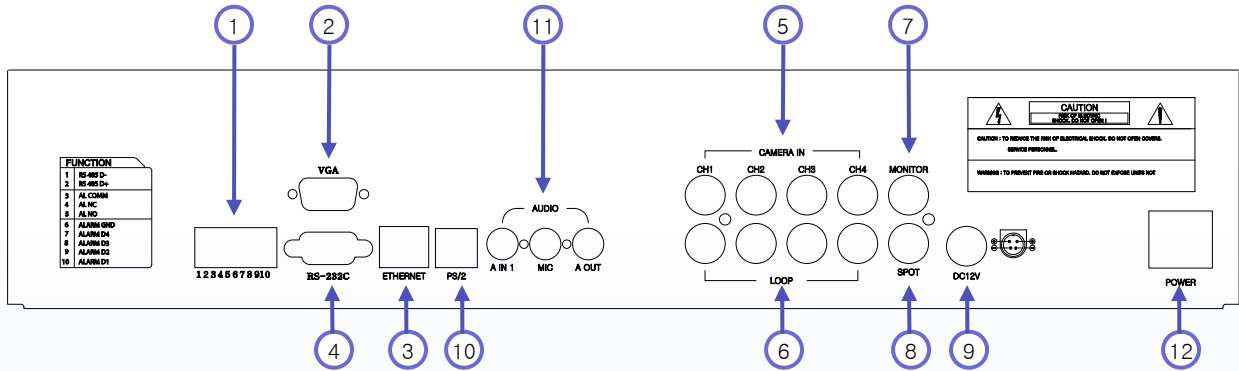

[8 Channel Rear]

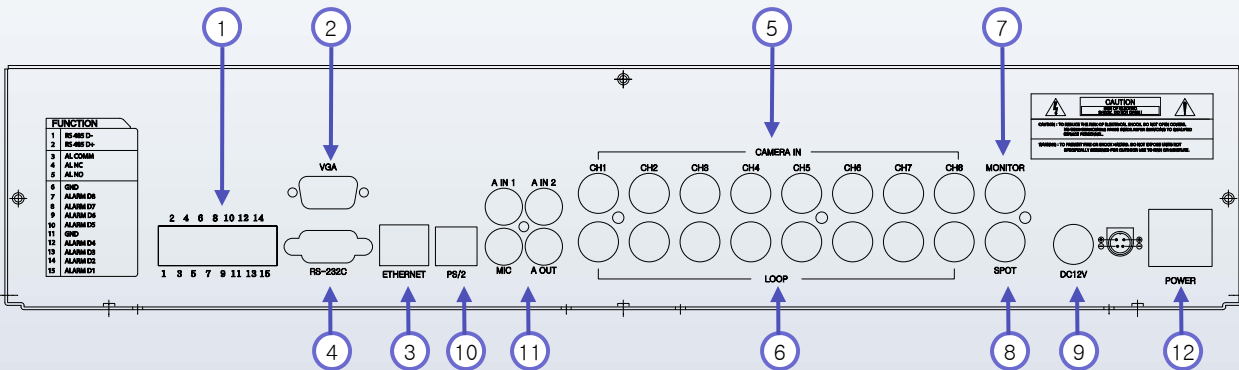

[16 Channel Rear]

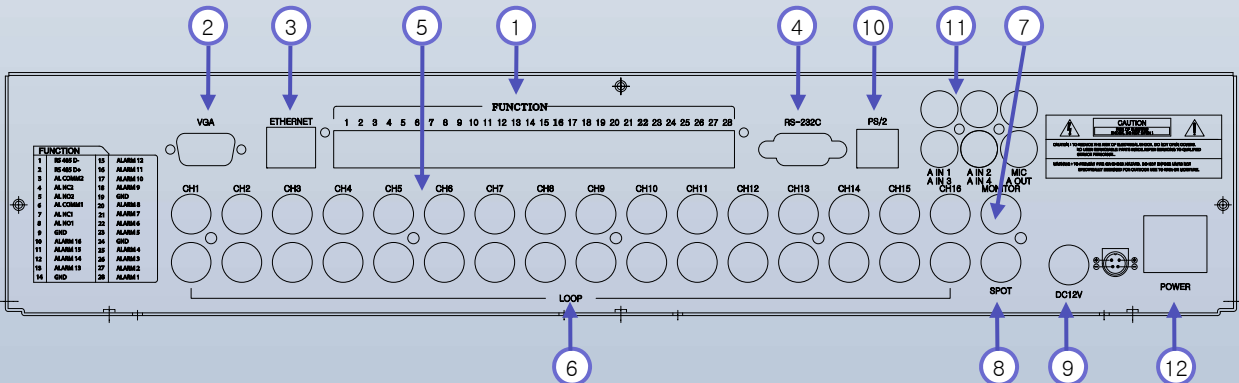

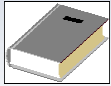

<Note>

You cannot mix NTSC and PAL equipment. For example you cannot use a PAL camera and a NTSC monitor.

No	Name	Function
1	RS485	Connection with PTZ Camera or other external devices using RS485
	RELAY Output	Relay Output terminal
	SENSOR Input	Sensor Input terminal
2	VGA	VGA Output to CRT or TFT LCD Monitors
3	ETHERNET	Connection to Ethernet devices
4	RS232C	Connection to external devices such as PC using RS232C to control DVR
5	CAMERA	Connection with NTSC/PAL Cameras
6	LOOP	Camera Loop out
7	MONITOR	Connection with NTSC/PAL Composite Monitor
8	SPOT	Connection from Analog backup output to external devices
9	DC Power	DC 12V 6.67A Adaptor
10	PS2 Mouse	Connection to PS2 Mouse
11	Audio I/O	Audio input/output & Microphone input
12	POWER SWITCH	Power ON/OFF Switch

2-3. Connector Pin

[1] RS232

Connection with PC to view and control DVR.

No	Details	No	Details
1	N/C (Normal Close)	6	N/C (Normal Close)
2	RxD (Data Transmission)	7	N/C (Normal Close)
3	TxD (Data Transmission)	8	N/C (Normal Close)
4	N/C (Normal Close)	9	N/C (Normal Close)
5	GND (Ground)		

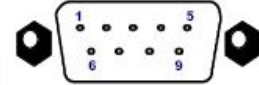

[2] VGA

VGA monitor output port to view screen via PC.

No	Details	No	Details
1	Red Sig.(75Ω, 0.7 p-p)	9	N/C (Normal Close)
2	Green Sig.(75Ω, 0.7 p-p)	10	GND (Ground)
3	Blue Sig.(75Ω, 0.7 p-p)	11	GND (Ground)
4	N/C (Normal Close)	12	N/C (Normal Close)
5	GND (Ground)	13	HYNC (Horizontal Sync.)
6	GND (Ground)	14	VSYNC (Vertical Sync.)
7	GND (Ground)	15	N/C (Normal Close)
8	GND (Ground)		

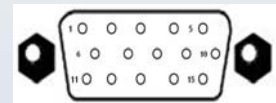

[3] LAN

No	Details	No	Details
1	TX+ (Data Transmission)	5	N/C (Normal Close)
2	TX- (Data Transmission)	6	R/X- (Data Transmission)
3	RX+ (Data Transmission)	7	N/C (Normal Close)
4	N/C (Normal Close)	8	N/C (Normal Close)



[4] CAMERA input & LOOP output

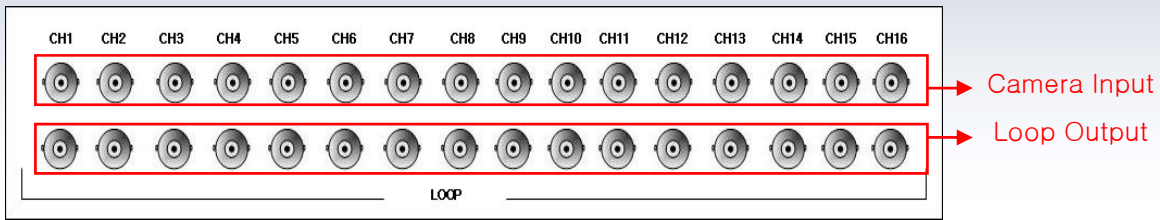

[5] AUDIO

AIN1 ~ AIN 4: Audio Input CH1 ~ CH4

MIC: Microphone Input

AOUT: Audio Output

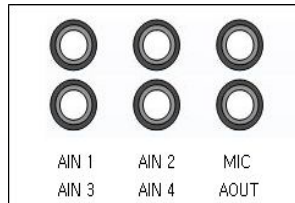

[6] External Device Connection : Connection with PTZ camera, sensor, relay output.



No	Details	No	Details	No	Details	No	Details
1	RS485 D-	2	RS485 D+	3	AL COMM	4	AL NC
5	AL NO	6	ALARM GND	7	ALARM D4	8	ALARM D3
9	ALARM D2	10	ALARM D1				

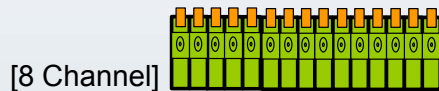

No	Details	No	Details	No	Details	No	Details
1	RS485 D-	2	RS485 D+	3	AL COMM	4	AL NC
5	AL NO	6	GND	7	ALARM D8	8	ALARM D7
9	ALARM D6	10	ALARM D5	11	GND	12	ALARM D4
13	ALARM D3	14	ALARM D2	15	ALARM D1		



No	Details	No	Details	No	Details	No	Details
1	RS485 D-	2	RS485 D+	3	AL COMM2	4	AL NC2
5	AL NO2	6	AL COMM1	7	AL NC1	8	AL NO1
9	GND	10	ALARM 16	11	ALARM 15	12	ALARM 14
13	ALARM 13	14	GND	15	ALARM 12	16	ALARM 11
17	ALARM 10	18	ALARM 9	19	GND	20	ALARM 8
21	ALARM 7	22	ALARM 6	23	ALARM 5	24	GND
25	ALARM 4	26	ALARM 3	27	ALARM 2	28	ALARM 1

CHAPTER 3. INSTALLATION

3-1. Configuration

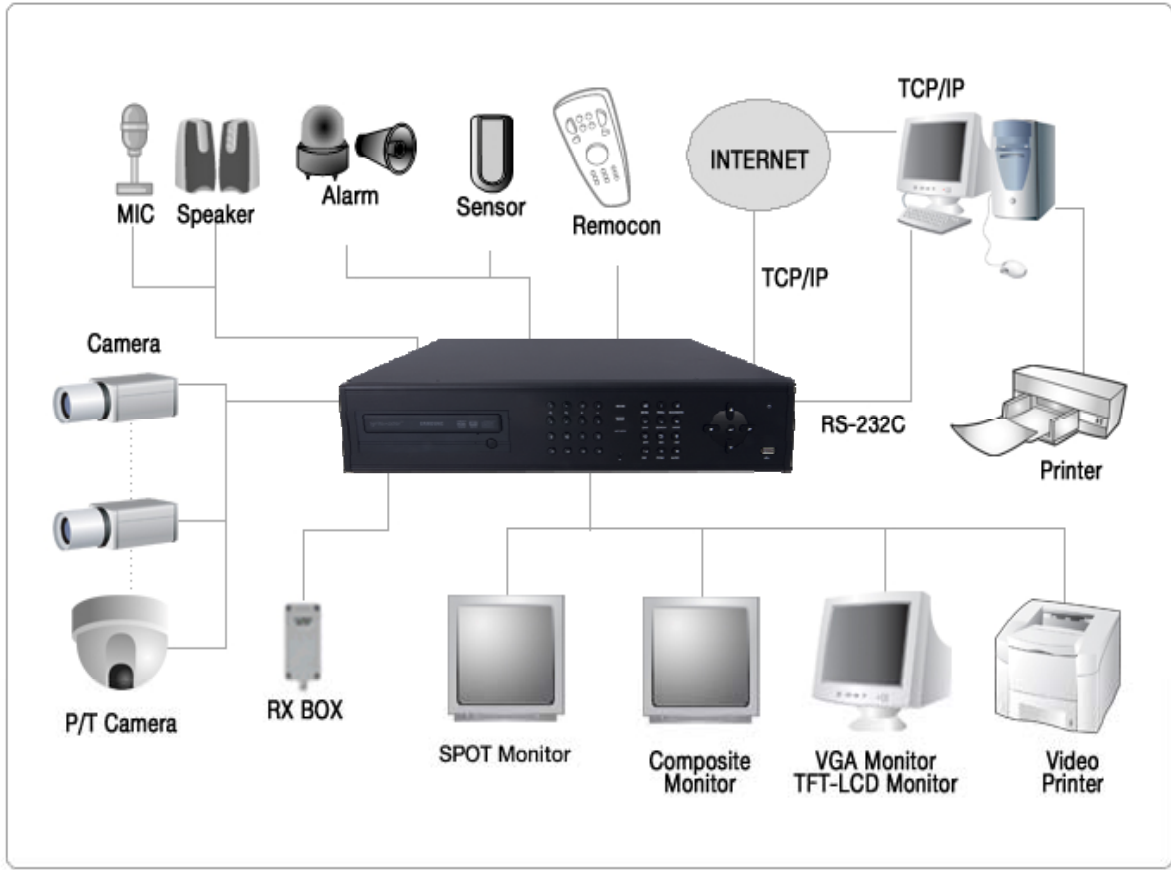

[Typical DVR Installation]

3-2. Detailed Configuration

1) Rack mount

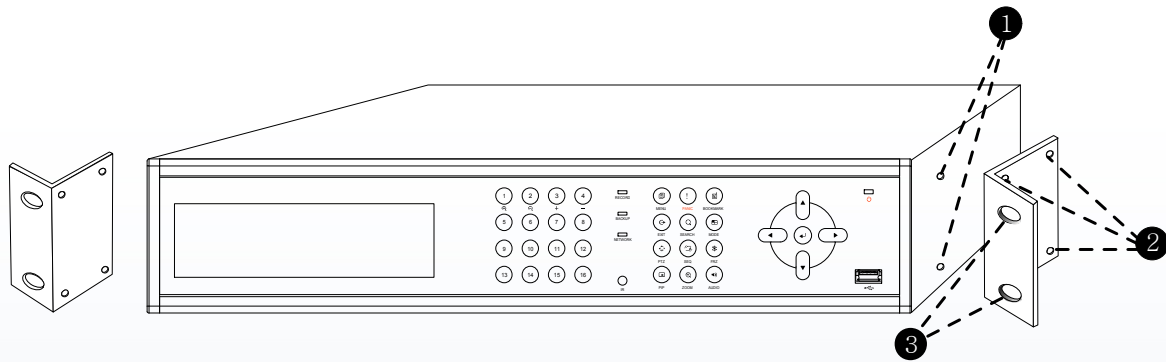

1. Remove all 4 bolts on side caps.
2. Attach Rack mount bracket to DVR.
3. Attach DVR with rack mount bracket to 19" Rack.

2) HDD (Hard Disk Drive) connection

1. Connect Main Board and HDD1 using SATA cable and HDD power cable.
2. When you use just 1 HDD, install the HDD onto HDD1 location.
3. When you use 2 HDDs, install the first HDD onto HDD1 location and then install the second HDD onto HDD2 location in order.
4. Install the HDD to the HDD bracket by using the bolts (included in the package).
5. Install HDD bracket into the bottom case.

[4 Channel]

HDD Cable Connection

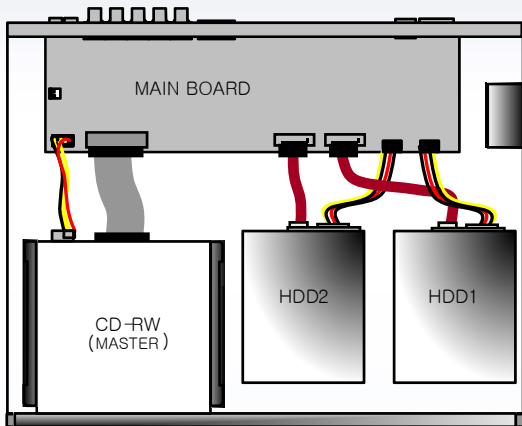

HDD Fix

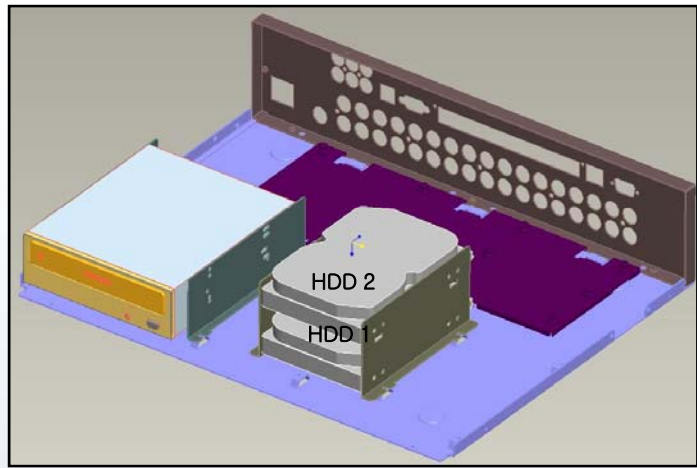

[8 Channel]

HDD Cable Connection

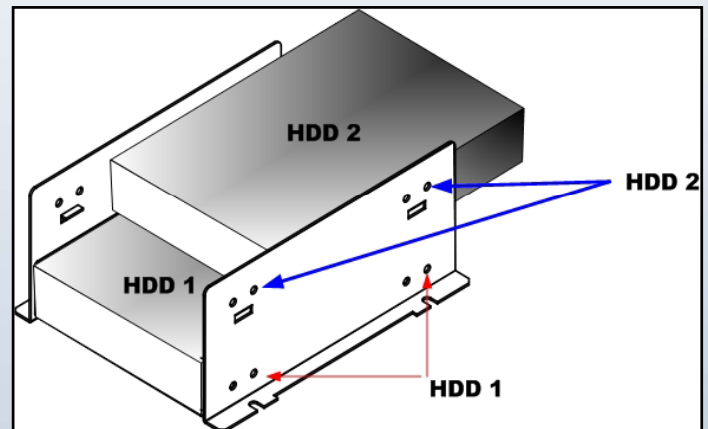
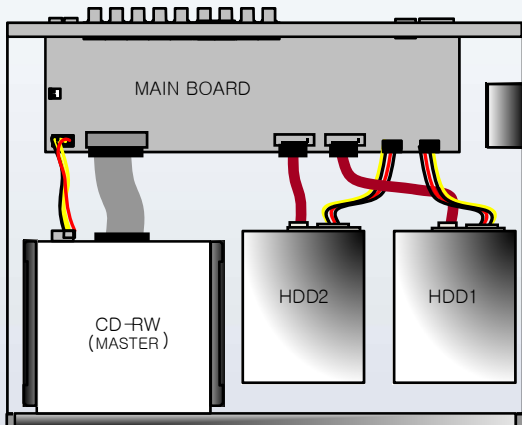

[16 Channel]

HDD Cable Connection

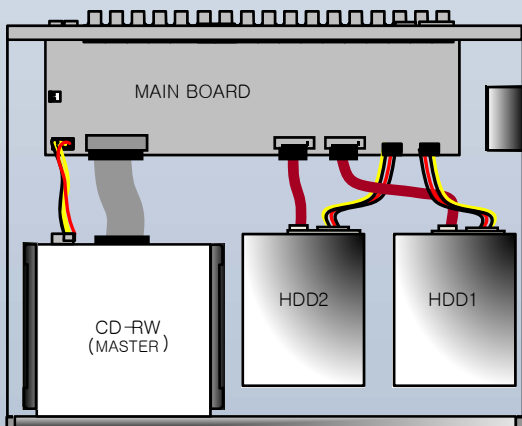

[3] Camera

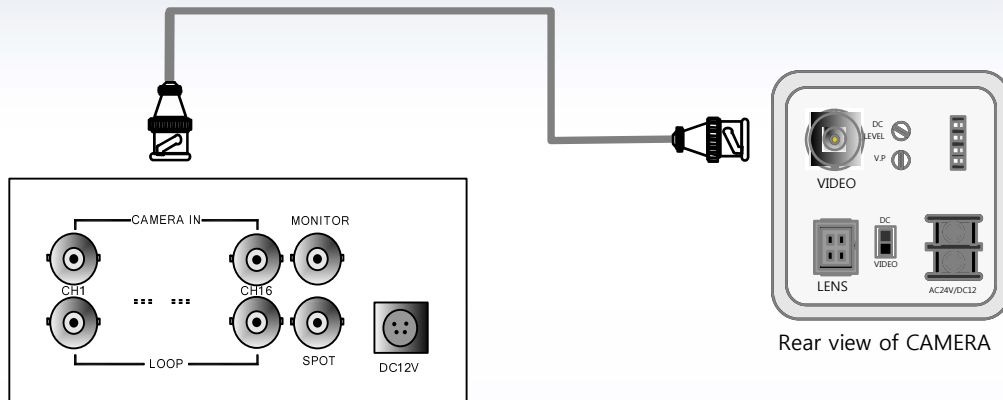

Connect cameras to the camera input on rear panel of DVR marked CAMERA IN.

[4] Monitor

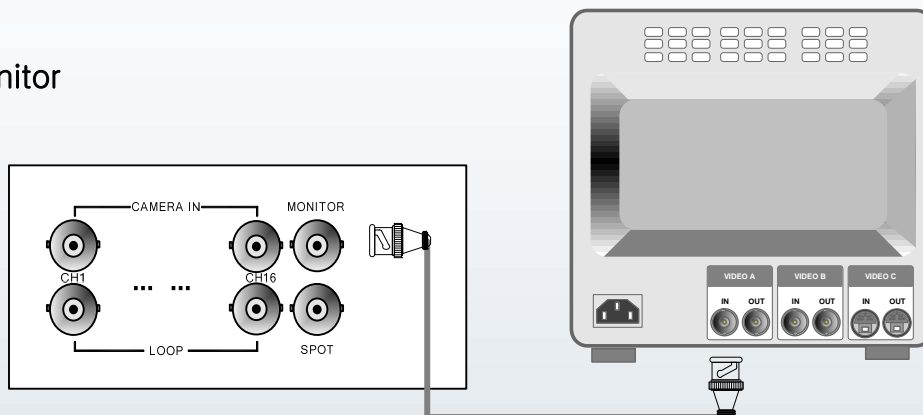

Connect the video output marked MONITOR to VIDEO-IN of Main Monitor.

[5] Power Cable

Connect DC 12V, 6.67A Adaptor to the back side of Power Jack for right operation of 2HDDs and CD Recorder.

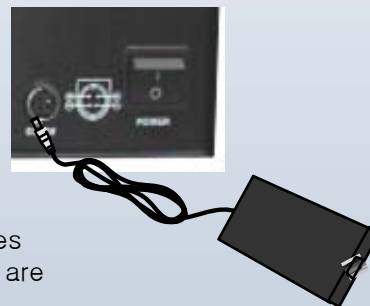

Before turning on, be sure all necessary devices such as Power adaptor, cameras and Monitor are connected properly to DVR!



<Note>

This unit is for DC 12V. Inadequate supply of power may cause breakdown. Be sure to power off DVR when connecting external devices.

[6] SPOT

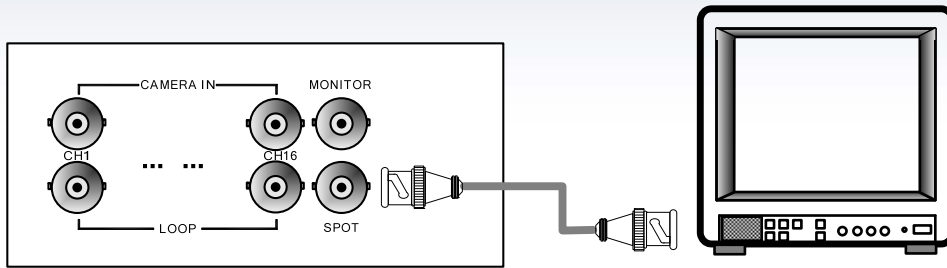

Connect with the spot monitor as needed.

[7] OTHERS

[4 Channel]

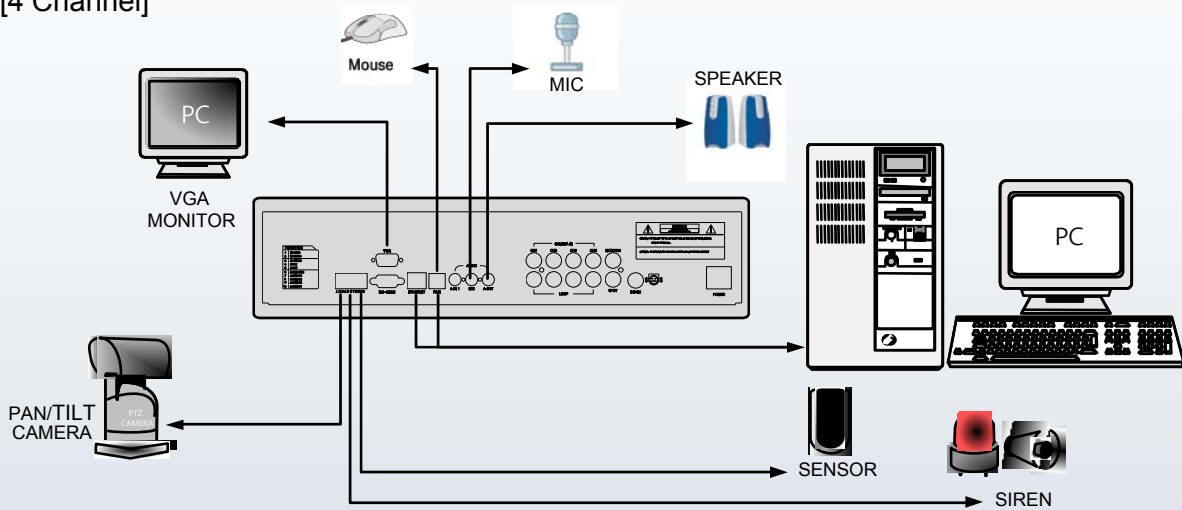

[8 Channel]

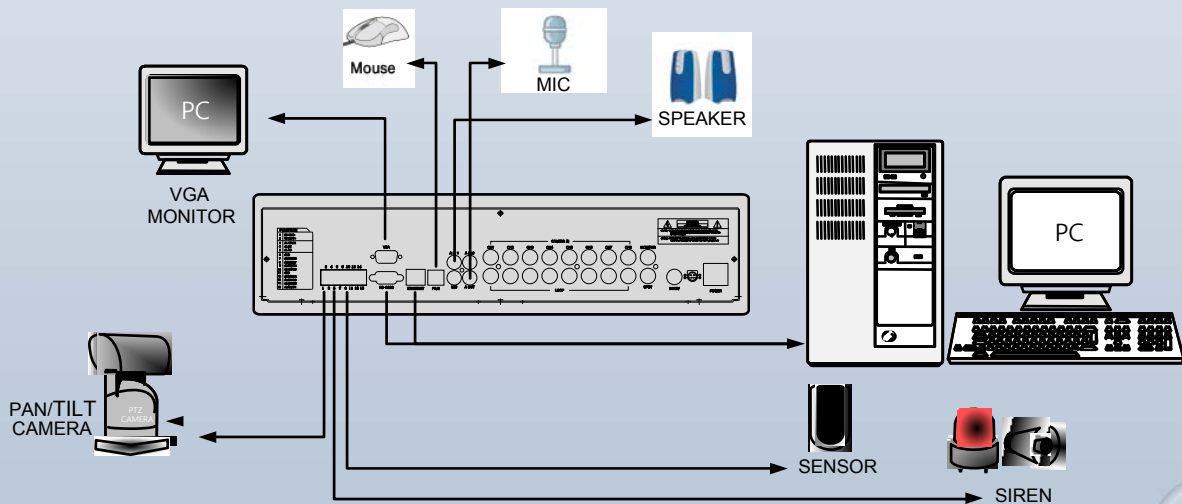

[16 Channel]

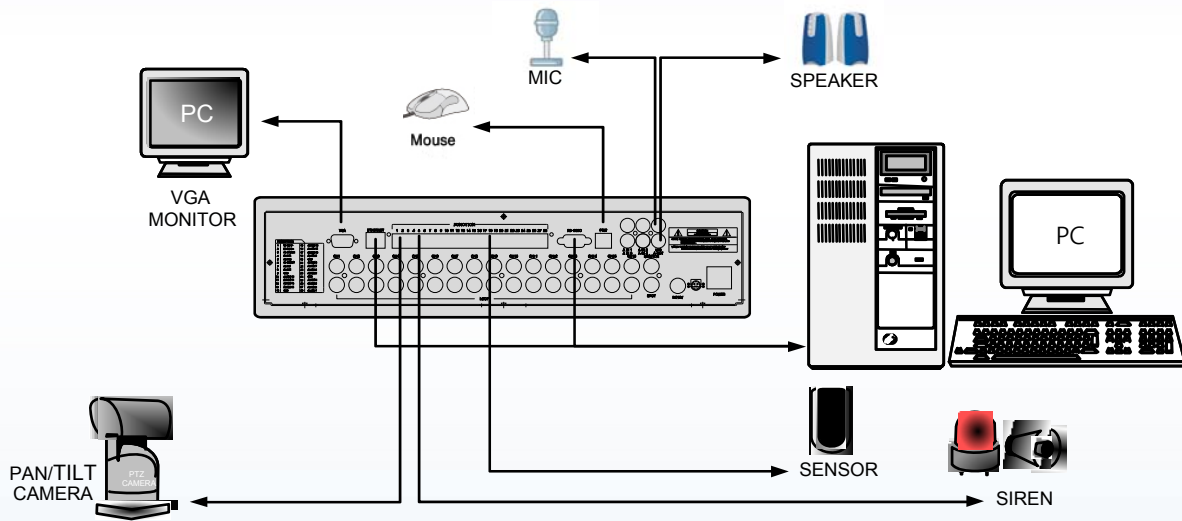

RS232C : Control DVR through RS232C port by using PC.

RS485 : Control external device such as PTZ Cameras.
(Pin No.1 ~ 2 at Terminal Block).

RELAY Output : (Pin No.3 ~8 at Terminal Block).

SENSOR Input : (Pin No.10 ~ 13 / No.15 ~ 18 / No.20 ~ 23 /
No.25 ~ 28 at Terminal Block).

GND : Ground (Pin No.9 / No.14 / No.19 / No.24 at Terminal Block).

ETHERNET : Connection to LAN, WAN and Internet.

VGA : Connection to VGA Monitor (CRT, TFT LCD Monitor)
Resolution is set to 800x600 60 Hz

User can change resolution in MONITOR SETUP / VGA SETUP /
VGA RESOLUTION.

Audio Input : Microphone Input (IN1~IN4)

Audio Output : Speaker Output (1ch OUT)

Microphone Input : Microphone Input (MIC)

CHAPTER 4. Display Configuration



1	Current Status	Date/Time, HDD, Playback
2	Display Status	Display status icons
3	Popup Menu	Monitoring popup menu in live mode Playback popup menu in playback mode PTZ control popup menu in PTZ mode
4	Toolbar	Playback toolbar, PTZ toolbar

4-1. Current Status

[1] Date/Time

Live mode : show current date & time

Playback mode : show recorded date & time of the playback image

[2] HDD

Live mode : HDD recorded space is marked red on the percentage bar.
Available remaining days/time at current record mode is shown.

Playback mode : Shows percentage of playback.

[3] Playback Mode

In Playback mode, F stands for Forward playback, B for Backward playback.

The numbers show playback speed.

Eg.) F 16x, B 2x

4-2. Display Status



[Stop Recording]



[Continuous Recording]



[Motion Recording]



[Alarm Recording]



[Panic Recording]



[Motion detected]



[Alarm-In detected]

4-3. Popup Menu

By clicking right button of mouse, Monitoring popup menu appears in live mode, Playback popup menu appears in playback mode, PTZ control popup menu appears in PTZ mode.

1) MONITORING POPUP MENU

While in LIVE display, click right button of mouse, and MONITORING popup appears.

In full screen mode: All sub-menus are activated.

In split screen mode: PTZ, Zoom, PIP menus are not activated.

In 16 split screen mode: Previous Page, Next Page, PTZ Control, Zoom, PIP are not activated.

1) Channel selection (Goto Channel) sub-menu : CAM01 ~ CAM16

MONITORING	
GOTO CHANNEL SPLITTER	CAM01
	CAM02
	CAM03
	CAM04
	CAM05
	CAM06
	CAM07
	CAM08
	CAM09
	CAM10
	CAM11
	CAM12
	CAM13
	CAM14
	CAM15
	CAM16
PTZ CONTROL	
FREEZE	
ZOOM	
SEQUENCE	
PIP	
AUDIO	
PANIC	
PLAYBACK	
SEARCH	
SETUP MENU	

2) 2x2, 3x3, 4x4 Split

Displays in 4, 9, 16 Screen Division:

Full : [60(50) IPS @ 720 x 480 (720 x 576)]

4 split : [240(200) IPS @ 360 x 240 (360 x 288)]

9 split : [540(450) IPS @ 240 x 160 (240 x 192)]

16 split : [960(800) IPS @ 180 x 120 (180 x 120)]

For 4ch/8ch DVR, 3X3 and 4X4 split sub-menus will not be activated.

MONITORING	
GOTO CHANNEL SPLITTER	2 x 2 Split 3 x 3 Split 4 x 4 Split Previous Page Next Page
PTZ CONTROL	
FREEZE	
ZOOM	
SEQUENCE	
PIP	
AUDIO	
PANIC	
PLAYBACK	
SEARCH	
SETUP MENU	

3) Previous Page

In full screen mode, clicking Previous Page menu will switch screen to lower number channel. After channel 1, it rotates to channel 16.

In split screen mode, clicking Previous Page menu will switch screen to lower number channel groups.

e.g.) [ch1/2/3/4] → [ch13/14/15/16] → [ch9/10/11/12] → [ch5/6/7/8]

In 16 split display mode, this function is not available.

4) Next Page

In full screen mode, clicking Next Page menu will switch screen to higher number channel. After channel 16, it rotates to channel 1.

In split screen mode, clicking Next Page menu will switch screen to higher number channel groups.

e.g.) [ch1/2/3/4] → [ch5/6/7/8] → [ch9/10/11/12] → [ch13/14/15/16]

In 16 split display mode, this function is not available.

5) PTZ Control

PTZ Panel pops up when PTZ Control menu is clicked. Click buttons with mouse control, or press SEQUENCE button to shift keys.

See Chapter 7-1 Live Monitoring 5] PTZ mode for more details.



[PTZ Control Toolbar]



[Virtual Joystick]

6) Freeze : On / Off

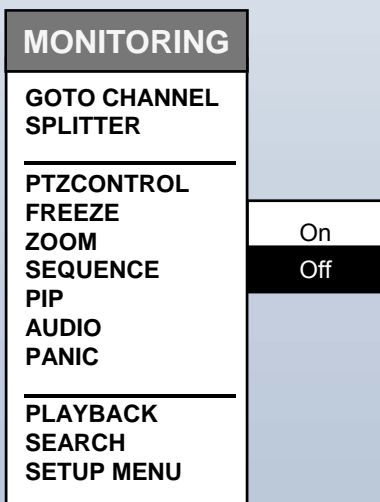

In Full screen mode, FRZ icon appears and screen freezes. In split screen mode, FRZ icon appears and all channels freeze.

To exit freeze mode, click any sub-menus from MONITORING except Audio and Panic.

7) Zoom : On / Off

In full screen mode, Zoom icon activates, and Live screen zooms in x2. Move selected frame by mouse control or arrow keys.
 In split screen mode, select channel button to activate zoom icon, and live screen zooms in x2.

To exit zoom mode, click any sub-menus from MONITORING except Audio and Panic.

8) Sequence : On / Off

While in full screen mode, clicking ON for sequence will cause channel of connected cameras to display sequentially according to the preset dwell time. Access [MENU]-[Display]-[Display]-[Main Monitor]-Sequence Interval Popup for dwell time setup, and Sequence Mode Popup to set number of channels to sequence.

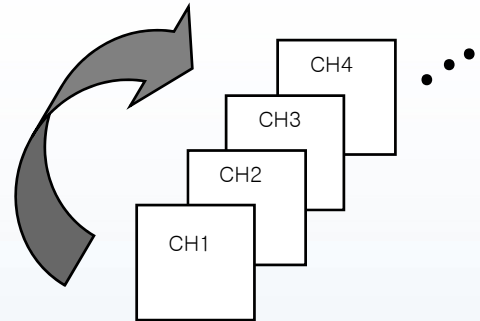

To exit Sequence mode, click any sub-menus from MONITORING except Audio and Panic.

9) PIP : On / Off

While in Live mode, one channel displays in full screen mode while another small screen displays in insert window.

Small screen displays in sequence according to preset interval. ([Menu]-[Display]-[Display]-[Main]-[Sequence Interval])

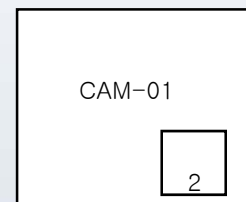

To exit PIP mode, click any sub-menus from MONITORING except Audio and Panic.

10) Playback

Press Playback from MONITORING popup menu or search menu, and play panel pops up as below and begin playback of recorded data on HDD. Freeze, Slow/Fast (reverse) playback control is available with play panel.

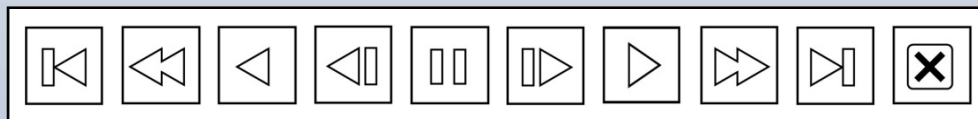

[Playback Control Toolbar]

11) Search

Only Admin and Manager have authority to access this Menu.
It is to search recorded data easily and playback.
Search by Time/Date, Event list and Bookmark is available.

12) Setup Menu

Only Admin and Manager have authority to access and change all settings on all Sub-Menus.

[2] PTZ CONTROL Popup



While in PTZ mode, click right button of mouse, and PTZ popup appears.

- 1) **Tour** : Pan/Tilt on all directions.
- 2) **Pattern** : Move designated PRESET position in order.
- 3) **Auto Pan** : Pan left/right automatically.
- 4) **Power** : On/Off
- 5) **Light** : Light on at night.
- 6) **Wiper** : Wipe moisture or water drops.
- 7) **Pump** : Pump water to remove dust.
- 8) **Device Menu** : Show OSD Menu of PTZ camera.
- 9) **Exit PTZ Control** : Exit and go back to Live view mode.

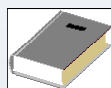

<Note>

Menus from 1) to 7) may not be available according to PTZ camera models.

[3] PLAYBACK Popup

While in Playback mode, click right button of mouse, and Playback popup appears.

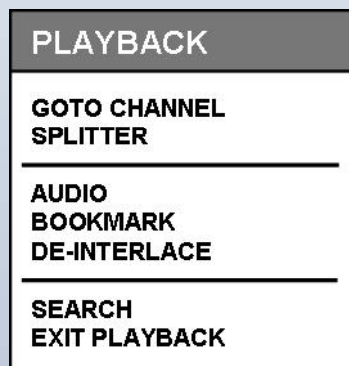

- 1) **Bookmark** : Clicking BOOKMARK button while in playback mode, time/date will be remembered for Bookmark Search.
- 2) **De-interlace** : Click DE-INTERLACE button while in playback mode. De-interlace is available via Interpolation.
- 3) **Search** : Clicking SEARCH button while in playback mode will stop playback mode, and goto search mode.

Other Menus are same as Menus in LIVE POPUP.

4-4. Toolbar

[1] PLAYBACK Toolbar

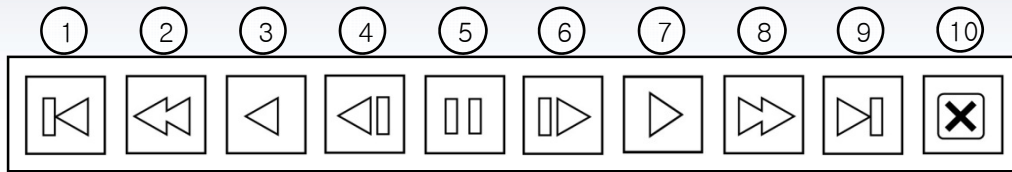

No.	Button	Function
1	Go to the first image	Move to the beginning of playback
2	Decrease speed	Playback speed decreases in forward playback (Playback speed increases in backward playback)
3	Backward playback	Playback in reverse direction
4	Previous image	Shows previous image in freeze mode
5	Freeze	Freeze playback
6	Next image	Shows next image in freeze mode
7	Forward Playback	Playback in forward direction
8	Increase speed	Playback speed increases in forward playback (Playback speed decreases in backward playback)
9	Go to the last image	Move to the end of playback
10	Exit	Exit playback mode, and return to live mode

[2] PTZ Toolbar



[PTZ Control Toolbar]

8



[Virtual Joystick]





No.	Button	Function
1	TELE	Zoom in
2	WIDE	Zoom out
3	NEAR	Focus near
4	FAR	Focus far
5	OPEN	Iris open
6	CLOSE	Iris close
7	EXIT	Exit PTZ toolbar
8	JOYSTICK	Camera Pan/Tilt operation

CHAPTER 5. DVR SETUP

5-1. Operation

1) Main Menu



Setup Group	Details
 Display	Display, Camera, Audio, Remote Control
 Record	Setup, Schedule, Pre-event, Backup
 Event	Alarm, Motion, Video Loss, Alarm-out, Buzzer
 Network	LAN, Notification
 System	Information, Date/Time, Storage, User, Logout

[1] Map of Screens

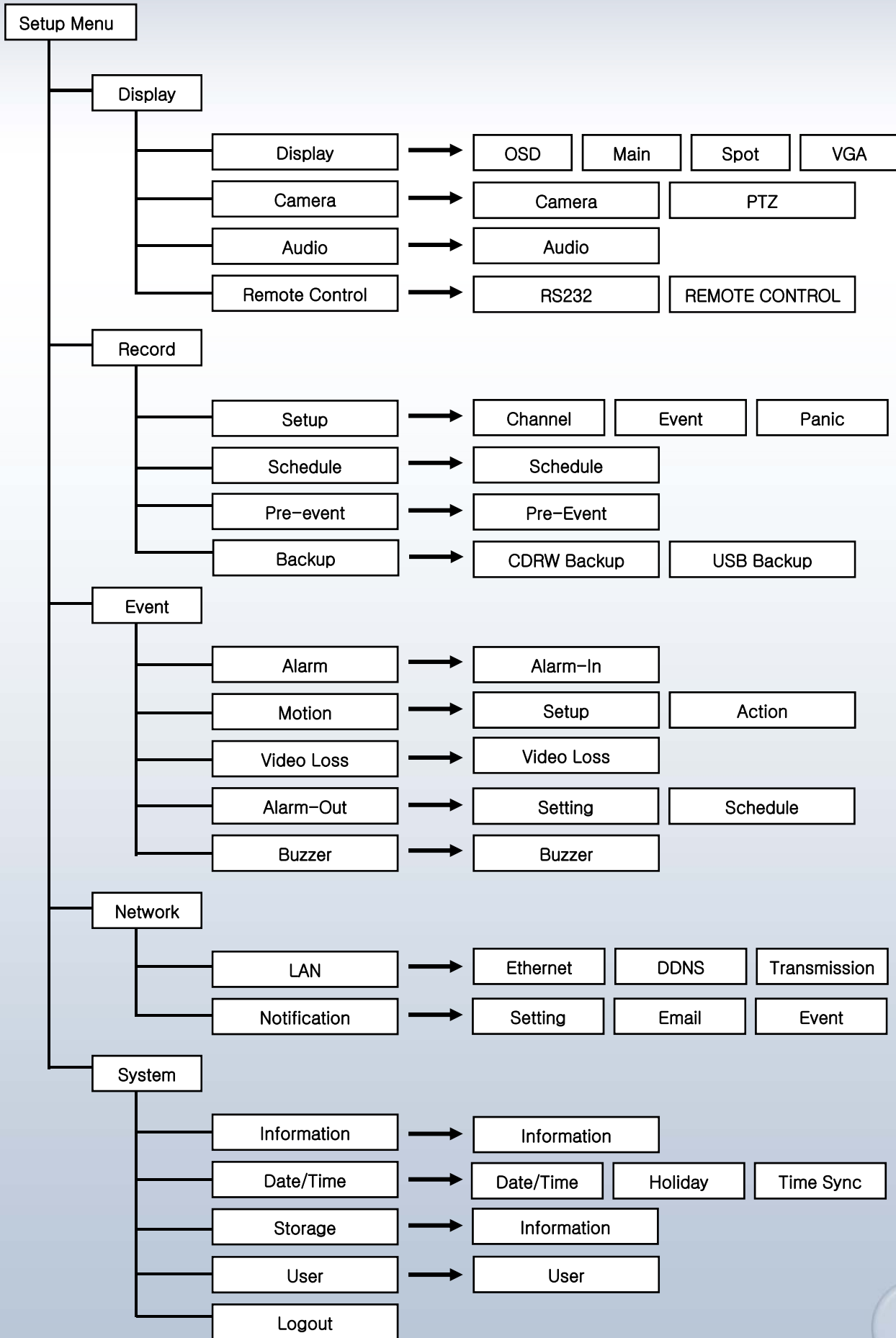

[2] Initialization

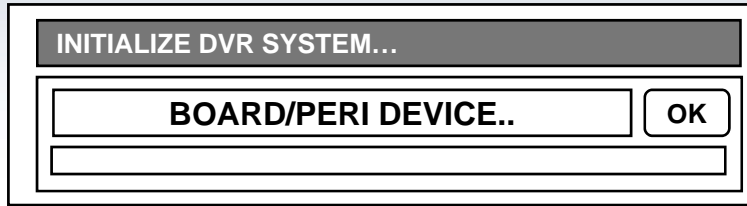

When powered on, messages displays in order.

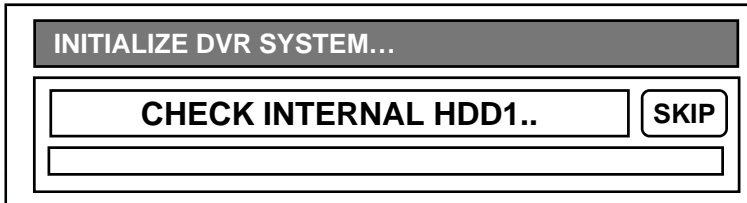

System will check for connected HDDs. If no HDD is connected, it will move to the next message. To skip checking HDD, click SKIP button or press [MENU] button.

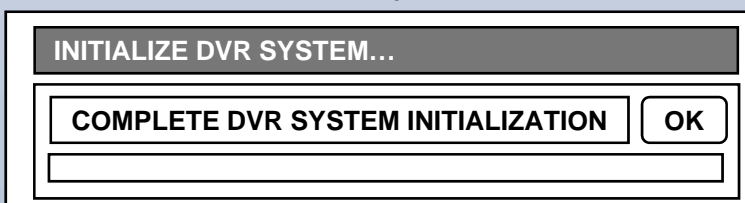
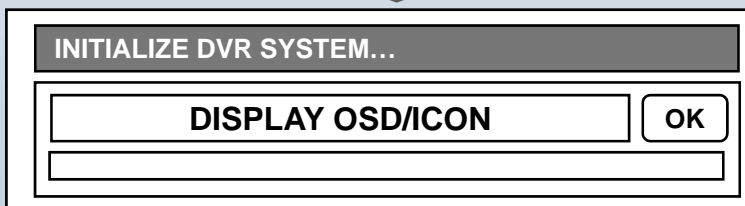
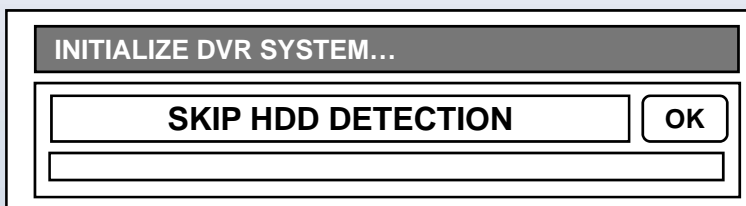
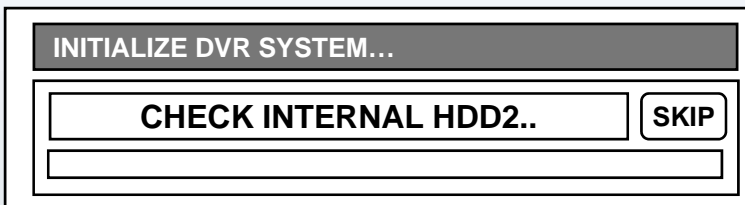
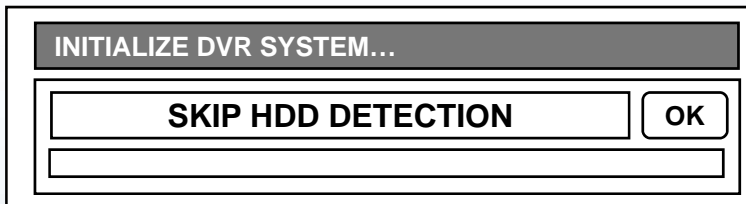

Once initialization is completed, live screen displays.

[3] System Login

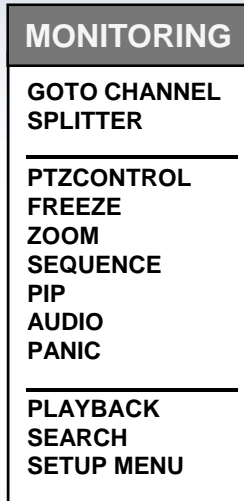

1) Press right button of mouse or press [MENU] button, and MONITORING popup appears.

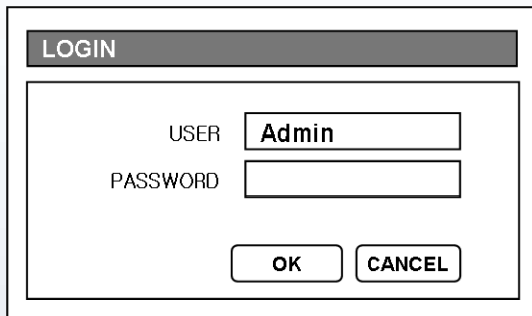

2) Click Setup Menu, and Login window pops up.

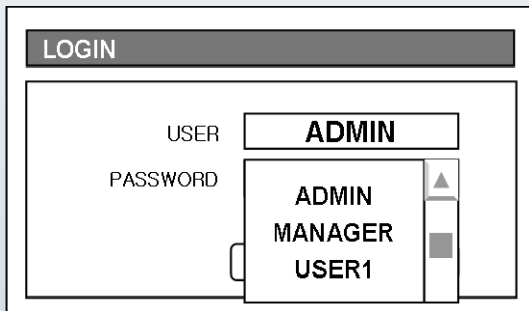

3) Click User and You can select user grade from the scroll box.

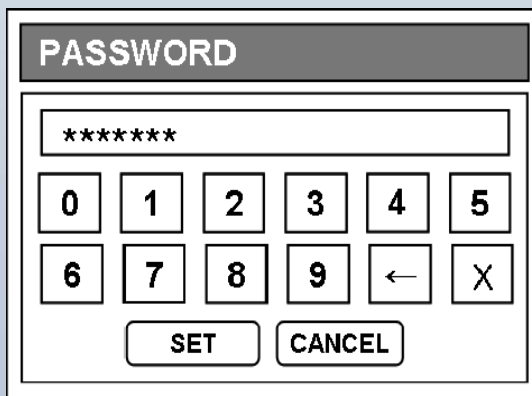

4) Input 1 to 8 digit number password of the selected user grade

← : Backspace
X : Clear all

Default Password :
Admin : blank (NUL)
Manager : 1
User 1~User 8 : 2 ~ 9

5-2. Display

[1] Display

1) OSD

OSD window allows you to select what information will be displayed in Live and Playback screen.

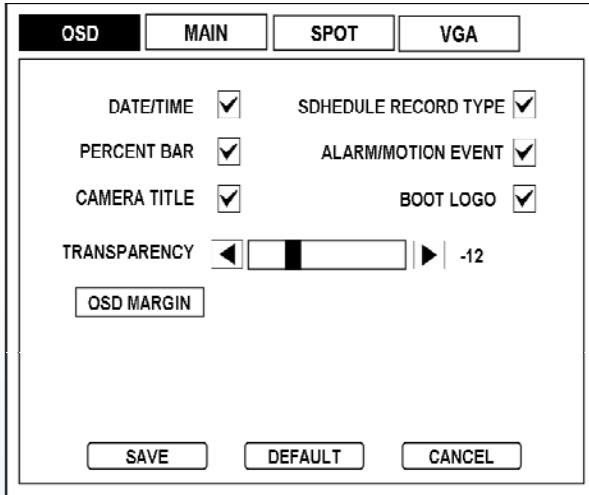

- **Date/Time** : Check checkbox to display Date/Time on Live screen.
- **Percentage Bar** : Check checkbox to display recorded percentage on HDD on Live screen.
- **Camera Title** : Check checkbox to display Camera Title on live screen.
- **Schedule Record Type** : Check checkbox to display currently recording type: Alarm, Motion, Time.
- **Alarm/Motion Event** : Check checkbox to display Alarm/Motion icon on Live screen.
- **Boot Logo** : Check checkbox to display Logo when system boots.
- **Transparency** : Adjust transparency using Left Right arrow buttons (from -32 to +31).
(The bigger the number, the darker the screen.)
- **OSD Margin** : Press OSD Margin button to set margin size.

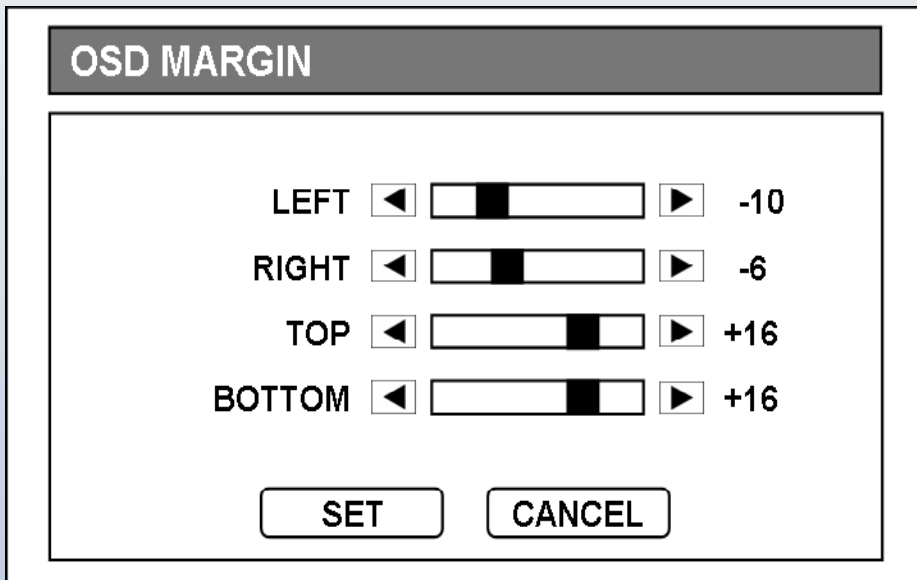

- Left : 0 ~ +30
- Right : 0 ~ +30
- Top : 0 ~ +30
- Bottom : 0 ~ +30

Adjust Left, Right, Top, Bottom margins so that text and icons do not hide beyond the edges of the screen.

See yellow lines on bottom left image : All margin values are set +30.

See yellow lines on bottom right image : Left margin value is set 0.

2) Main

If Event Popup Off, you can set DVR to sequence cameras.

If Event Popup on, event channel screen pops up.

OSD	MAIN	SPOT	VGA
SEQUENCE MODE	FULL 1 Ch		
SEQUENCE INTERVAL	2	SECOND	
EVENT POPUP	ON		
POPUP EVENT TYPE	MOTION		
POPUP DWELL	2	SECOND	
PIP	7		
DURATION	2	SECOND	
SAVE		DEFAULT	CANCEL

- Sequence Mode : Define layout to sequence between Full 1ch and 4ch split.
- Sequence Interval : Set interval among 1, 2, 3, 4, 5, 10, 15, 20, 30 seconds.
- Event Popup : Select On or Off for pop up screen in case event occurs.
- Popup Event Type : Select Event type between motion detection and Alarm.
- Popup Dwell : Set dwell time among 1, 2, 3, 4, 5, 10, 15, 20, 30 seconds.
- PIP : Set location of insert window (Upper part :0~2, Middle part: 3~4, Lower part: 5~7)
- Duration : Switching interval for PIP insert window. (1,2,3,4,5,10,15,20,30)



<Note>

In case events (Motion or Alarm) occur on several channels at the same time, channel 1 has the first priority to pop up.

Ex) If events occur on channel 1, channel 2 and channel 4 at the same time, channel 1 pops up.

Only when pop up of channel 1 ends, then channel 2 pops up for the set dwell time.

However, even when motion is detected on channel 1 again within the dwell time of channel 2, pop up of channel 2 stays in display.

If motion is still detected on channel 1 after dwell time, channel 1 pops up again.

3) Spot

OSD	MAIN	SPOT	VGA
-----	------	------	-----

SPOT MONITOR

SPOT EVENT TYPE

SPOT DWELL SECOND

SPOT CHANNEL

- **Spot Monitor** : Set Spot monitor On or Off.
- **Spot Event Type** : Select Event type among Motion, Alarm and both.
- **Spot Dwell** : Set dwell time among 1, 2, 3, 4, 5, 10, 15, 20, 30 seconds.
- **Spot Channel** : Click Spot Channel button to popup Spot Channel Selection window.

SELECT SPOT CHANNEL

CH 1 <input checked="" type="checkbox"/>	CH 2 <input checked="" type="checkbox"/>	CH 3 <input checked="" type="checkbox"/>	CH 4 <input checked="" type="checkbox"/>
CH 5 <input checked="" type="checkbox"/>	CH 6 <input checked="" type="checkbox"/>	CH 7 <input checked="" type="checkbox"/>	CH 8 <input checked="" type="checkbox"/>
CH 9 <input checked="" type="checkbox"/>	CH 10 <input checked="" type="checkbox"/>	CH 11 <input checked="" type="checkbox"/>	CH 12 <input checked="" type="checkbox"/>
CH 13 <input checked="" type="checkbox"/>	CH 14 <input checked="" type="checkbox"/>	CH 15 <input checked="" type="checkbox"/>	CH 16 <input checked="" type="checkbox"/>

Check checkbox of camera channel to activate Spot output.

4) VGA

Set Resolution of monitor.

VGA Card is necessary to connect DVR to TFT LCD or CRT monitors. Check resolution range of your VGA monitor first and select VGA CARD resolution among list below:

OSD	MAIN	SPOT	VGA
-----	------	------	-----

VGA RESOLUTION

- 640 X 480 / 60 HZ
- 800 X 600 / 60HZ
- 1024 X 768 / 60HZ
- 1280 x 1024 / 60 HZ
- 640 x 480 / 75 HZ
- 800 x 600 / 75 HZ
- 1024 x 768 / 75 HZ
- 1280 x 1024 /75 HZ

[2] Camera

1) Camera

Set title, color, hue, contrast of cameras.

CAMERA		PTZ	
NO.	TITLE	COVERT	ADJUSTMENT
01	CAM01	Off	...
02	CAM02	Off	...
03	CAM03	Off	...
04	CAM04	Off	...
PREVIOUS		Ch-01 ~ Ch-04	NEXT
SAVE		DEFAULT	CANCEL

- **No.:** Click to popup Copy Setting box.
- **Title :** Change the Title of each camera using the virtual keyboard (Maximum 12 letters)
- **Covert :** Select ON channel will not be displayed on Live View screen.
- **Adjustment :** Adjust display brightness, contrast, saturation, hue, horizontal position of each camera.

Click title of camera and virtual keyboard pops up.

You can change the title of each camera using virtual keyboard.

TITLE												
CAM01												
0	1	2	3	4	5	6	7	8	9	a	b	c
d	e	f	g	h	i	j	k	l	m	n	o	p
q	r	s	t	u	v	w	x	y	z	_	=	[
]	\	'	,	.	/	'				⌫	X	⏏
SET						CANCEL						

<Note>

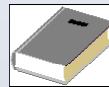

After typing in title, press Set button to save title.

- Title can be of maximum 12 letters.
- <- : backspace X: clear all
- ⏏ : Caps Lock

Click Adjustment button, and Camera Color/H setup window pops up.

CAMERA COLOR / H-POS	
BRIGHTNESS	◀ [Slider] ▶ -10
CONTRAST	◀ [Slider] ▶ -6
SATURATION	◀ [Slider] ▶ +16
HUE	◀ [Slider] ▶ +16
POSITION	◀ [Slider] ▶ +7
SET CANCEL	

- Brightness : -32 ~ +31
- Contrast : -32 ~ +31
- Saturation : -32 ~ +31
- Hue : -32 ~ +31
- Position : -16 ~ +15

2) PTZ

CAMERA		PTZ		
NO.	PROTOCOL	PTZ ID	SPEED	BAUDRATE
01	PELCO-D	1	7	9600
02	PELCO-D	2	7	9600
03	PELCO-D	3	7	9600
04	PELCO-D	4	7	9600
PREVIOUS		Ch-01 ~ ch-04	NEXT	
SAVE		DEFAULT	CANCEL	

- **Protocol** : Click Protocol column and select camera from the list.
- **PTZ ID** : Assign IDs to each camera from 0 to 255.
- **Speed** : Set PTZ control speed from 1 to 7 level.
- **Baud rate** : Set RS485 communication speed.
Set communication speed among 9600, 19200, 38400, 57600 and 115200.
- **PAN**: Left Right movement
- **TILT**: Up Down movement
- **ZOOM**: Zoom In Out
- **FOCUS**: Focus Near Far

[Recommended PTZ Camera list]

Manufacturer	Model
PELCO	PELCO-D, PELCO-P
Samsung	SCC-641
LG	MULTIX
Unitech	DRX502A, DSC230S
Hitron	Fastrax II E
NOVUS	NOVUS-C1, NOVUS-C2, N-CONTROL
VIDO	AU-GXX
ONIX	ON-D
Sin Tech	SU320
SENSORMATIC	SENSORMATIC
LILIN	MERIT LILIN
ACCUDOME	AUCOME Model Others: AECD-2000, HMC250, TBT, D-MA, NOTETCH-A Vista PowerDome
VISTA	

[3] Audio

AUDIO			
NO.	RECORD	PLAYBACK	AUDIO OUT
1	<input checked="" type="checkbox"/>	<input checked="" type="checkbox"/>	<input checked="" type="checkbox"/>
2	<input checked="" type="checkbox"/>	<input checked="" type="checkbox"/>	<input checked="" type="checkbox"/>
3	<input checked="" type="checkbox"/>	<input checked="" type="checkbox"/>	<input checked="" type="checkbox"/>
4	<input checked="" type="checkbox"/>	<input checked="" type="checkbox"/>	<input checked="" type="checkbox"/>

- **Record** : Check checkbox to record with audio. Otherwise, audio will not be recorded.
- **Playback** : Check checkbox to playback with audio sound.
- **Audio Out** : Check checkbox to turn audio on in Live mode.

[4] Remote Control

1) RS232

RS232	REMOTE CONTROL
BAUDRATE	<input type="text" value="115200"/>
DATE BITE	<input type="text" value="8"/>
STOP BITE	<input type="text" value="1"/>
PARITY	<input type="text" value="NONE"/>
<input type="button" value="SAVE"/> <input type="button" value="DEFAULT"/> <input type="button" value="CANCEL"/>	

- Baud rate : Set value among 1200, 2400, 4800, 9600, 19200, 38400, 57600, 115200.
- Data bite : Set value from 5 to 8.
- Stop bite : Set value between 1 and 2.
- Parity : Set value among None, Odd and Even.

2) REMOTE CONTROL

Set Remote Control Type.

RS232	REMOTE CONTROL
REMOTE CONTROL TYPE	<input type="text" value="SINGLE"/>
<input type="button" value="SAVE"/> <input type="button" value="DEFAULT"/> <input type="button" value="CANCEL"/>	

- Remote Control Type : Set Remote Control Type for remote control for more than 2 DVRs.
Set remote Control Type among 7 types : S TYPE, U TYPE 1 ~ U TYPE 6.

5-3 Record

[1] Setup

Channel : Set recording for Continuous recording

Event : Set recording for Alarm and Motion detection

Panic : Set recording for panic recording

1) Channel

Set continuous recording quality for each channel.

CHANNEL		EVENT	PANIC	
No.	RESOLUTION	QUALITY	FPS	
01	H-D1	Very High	3	
02	GIF	Very High	12	
03	D1	Very High	12	
04	CIF	Very High	12	
PREVIOUS		1/4	NEXT	
OVERWRITE <input type="checkbox"/>		REMAIN FPS	222/240	
ESTIMATED DAY/HDD		1	ESTIMATED SIZE/DAY	
			113GB	
SAVE		DEFAULT		CANCEL

- No.: Click to popup Copy Setting box.
- Resolution : Set resolution among CIF, H-D1 & D1.
- Quality : Set recording quality among Low, Normal, High and Very High.
- FPS : Set frames per second among 1, 2, 3, 4, 5, 6, 7(8), 10(12), 15(25) & 30.
- Overwrite : Check checkbox to enable recording over the oldest data once all available storage space has been used.
- Remain FPS : Remaining Frames per Second.
- Estimated Day/HDD : Estimated remaining available time for HDD with no recorded data based on quality related settings.
- Estimated Size/Day : Estimated required size of HDD for 24 hour recording based on above settings.

2) Event

Set event recording quality for each channel.

CHANNEL	EVENT	PANIC	
No.	RESOLUTION	QUALITY	FPS
01	H-D1	Very High	3
02	CIF	Very High	12
03	D1	Very High	12
04	CIF	Very High	12
PREVIOUS	1/4	NEXT	
REMAIN FPS		222/240	
ESTIMATED DAY/HDD		1	ESTIMATED SIZE/DAY 112GB
SAVE		DEFAULT	
		CANCEL	

3) Panic

Set panic recording quality for each channel.

CHANNEL	EVENT	PANIC	
No.	RESOLUTION	QUALITY	FPS
01	H-D1	Very High	3
02	CIF	Very High	12
03	D1	Very High	12
04	CIF	Very High	12
PREVIOUS	1/4	NEXT	
REMAIN FPS		222/240	
ESTIMATED DAY/HDD		1	ESTIMATED SIZE/DAY 112GB
SAVE		DEFAULT	
		CANCEL	

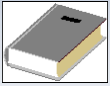

< Note >

Below is the 500GH HDD calculation for Estimated Size/Day and Estimated Day/HDD according to Resolution and Quality

CIF	Quality: Low	Quality: Normal	Quality: High	Quality: Very High
1fps	16GBx27day	19GBx23day	23GBx19day	27GBx16day
2fps	19GBx23day	20GBx21day	26GBx17day	31GBx14day
3fps	20GBx21day	23GBx19day	27GBx16day	34GBx13day
4fps	20GBx21day	23GBx17day	30GBx15day	38GBx12day
5fps	22GBx22day	23GBx17day	31GBx14day	39GBx11day
6fps	22GBx22day	24GBx18day	30GBx15day	40GBx11day
7fps	24GBx18day	30GBx15day	33GBx12day	51GBx8day
8fps	27GBx16day	34GBx13day	43GBx10day	59GBx7day
15fps	30GBx15day	40GBx11day	48GBx9day	69GBx6day
30fps	40GBx11day	49GBx9day	67GBx6day	100GBx4day

H-D1	Quality: Low	Quality: Normal	Quality: High	Quality: Very High
1fps	27GBx16day	35GBx12day	42GBx10day	52GBx8day
2fps	30GBx15day	38GBx12day	44GBx10day	56GBx8day
3fps	32GBx14day	38GBx12day	47GBx9day	59GBx7day
4fps	36GBx12day	44GBx10day	55GBx8day	73GBx6day
5fps	38GBx12day	47GBx9day	56GBx8day	77GBx5day
6fps	38GBx12day	47GBx9day	57GBx7day	77GBx5day
7fps	47GBx9day	56GBx9day	73GBx6day	105GBx4day
8fps	51GBx8day	61GBx7day	85GBx5day	119GBx3day
15fps	56GBx8day	72GBx6day	98GBx4day	148GBx3day
30fps	78GBx5day	74GBx6day	148GBx3day	245GBx1day

D1	Quality: Low	Quality: Normal	Quality: High	Quality: Very High
1fps	31GBx14day	40GBx11day	63GBx7day	80GBx5day
2fps	34GBx13day	44GBx10day	69GBx6day	93GBx4day
3fps	38GBx12day	49GBx9day	74GBx6day	98GBx4day
4fps	39GBx11day	53GBx8day	82GBx5day	113GBx4day
5fps	40GBx11day	57GBx7day	92GBx4day	130GBx3day
6fps	42GBx10day	57GBx7day	90GBx5day	130GBx3day
7fps	44GBx10day	63GBx7day	97GBx4day	140GBx3day
8fps	45GBx9day	69GBx6day	117GBx3day	172GBx2day
15fps	47GBx9day	76GBx6day	136GBx3day	213GBx2day
30fps	60GBx7day	117GBx3day	225GBx2day	382GBx1day

[2] Schedule

Set Time and Type of Schedule recording for each channel.

SCHEDULE

CHANNEL

CH1

RECORD TYPE

OFF

ALL	0	1	2	3	4	5	6	7	8	9	10	11	12	13	14	15	16	17	18	19	20	21	22	23
SUN																								
MON																								
TUE																								
WED																								
THU																								
FRI																								
SAT																								

OFF
 ALARM_IN
 MOTION
 TIME

ALARM+MOTION
 ALARM+TIME
 MOTION+TIME

SAVE

DEFAULT

CANCEL

- Record Type : Time : CONTINUOUS
- ALARM-IN : Sensor In
- MOTION : Motion Detection

Channel button : Click to popup Copy Setting box.

In normal cases (Unless you press Panic button), DVR records based on the schedule established in the Schedule.

The Default mode is continuous recording.



< Note >

- RED: Alarm-In
- GREEN: Motion
- BLUE: Time
- YELLOW: Alarm + Motion
- SKY: Alarm + Time
- PURPLE: Motion + Time
- TRANSPARENT: Off

[3] Pre-Event

Set Quality and recording time for Pre-Event, which save recorded data before event occurs.

PRE-EVENT

CH 1 <input type="checkbox"/>	CH 2 <input type="checkbox"/>	CH 3 <input type="checkbox"/>	CH 4 <input type="checkbox"/>
CH 5 <input type="checkbox"/>	CH 6 <input type="checkbox"/>	CH 7 <input type="checkbox"/>	CH 8 <input type="checkbox"/>
CH 9 <input type="checkbox"/>	CH 10 <input type="checkbox"/>	CH 11 <input type="checkbox"/>	CH 12 <input type="checkbox"/>
CH 13 <input type="checkbox"/>	CH 14 <input type="checkbox"/>	CH 15 <input type="checkbox"/>	CH 16 <input type="checkbox"/>

QUALITY (CIF)

FPS

ESTIMATED DAY/HDD SECOND

- **Channel checkbox** : Check checkbox to turn each camera on for pre-event recording.
- Set each camera on or off for pre-event recording.
- **Quality** : Set recording quality among Low, Normal, High & Very High.
- **FPS** : Set Frames per Second 1, 2, 3, 4, 5, 6, 7, 10, 15 & 30.
- **Estimated Day/HDD** : Pre-event recording time will automatically be calculated according to quality and FPS, within the range of memory.



<Note>

When the DVR is in the Time or Time+Event recording mode, it ignores the Pre-event setting and follows the Time setting.

[4] Backup

1) CD-RW Backup

CDRW BACKUP		USB BACKUP	
RECORDED VIDEO INFORMATION			
FROM	2008/02/26 06:54:41		
TO	2008/02/26 06:54:41		
BACKUP INFORMATION			
MEDIA	--- MB		BACKUP FILE NAME
FROM	2008	02	26 05 54 41
TO	2008	02	26 05 54 41
BACKUP SIZE	0 MB		CHECK BACKUP SIZE
STATUS	BACKUP DEVICE INIT.		
START		EXIT	

Recorded image Information

- **From** : Start time of recorded data on HDD.
- **To** : End time of recorded data on HDD.

Backup Information

- **Media** : Size of the inserted media (CD/DVD).
- **From** : Start time of data to backup on CD-RW.
- **To** : End time of data to backup on CD-RW.
- **Backup Size** : Total size of data to backup from 1MB to available media size.
- **Check Backup Size** : This button is for use of 2 options:
 1. First set start time of data to backup. And set Backup size and click Check Backup Size button to automatically calculate End time.
 2. or First set start time of data to backup. And Set End time and click Check Backup Size to automatically calculate Backup Size.
- **Status** : Message shows current status of system.
(See chapter 11 for more details)
- **Backup File Name** : Create backup file name.

CDRW BACKUP		USB BACKUP	
RECORDED VIDEO INFORMATION			
FROM	2008/02/26 06:54:41		
TO	2008/02/26 06:54:41		
BACKUP INFORMATION			
MEDIA	--- MB		BACKUP FILE NAME
FROM	2008	02	26 05 54 41
TO	2008	02	26 05 54 41
BACKUP SIZE	0 MB		CHECK BACKUP SIZE
STATUS	BACKUP DEVICE INIT.		
START		EXIT	

Recorded image Information

- **From** : Start time of recorded data on HDD.
- **To** : End time of recorded data on HDD.

Backup Information

- **Media** : Size of the inserted media (CD/DVD).
- **From** : Start time of data to backup on CD-RW.
- **To** : End time of data to backup on CD-RW.
- **Backup Size** : Total size of data to backup from 1MB to available media size
- **Check Backup Size** : This button is for use of 2 options:
 1. First set start time of data to backup. And set Backup size and click Check Backup Size button to automatically calculate End time.
 2. or First set start time of data to backup. And Set End time and click Check Backup Size to automatically calculate Backup Size.
- **Status** : Message shows current status of system.
(See chapter 11 for more details)
- **Backup File Name** : Create backup file name.

5-4. Event

[1] Alarm

1) Alarm-In

Set sensor On / Off and Dwell time for each channel in case external sensor activates.

ALARM-IN

NO.	TYPE	BEEP	ALARM-OUT		DURATION	
01	N.O	OFF	1 <input type="checkbox"/>	2 <input type="checkbox"/>	1	SECOND
02	N.O	OFF	1 <input type="checkbox"/>	2 <input type="checkbox"/>	1	SECOND
03	N.O	OFF	1 <input type="checkbox"/>	2 <input type="checkbox"/>	1	SECOND
04	N.O	OFF	1 <input type="checkbox"/>	2 <input type="checkbox"/>	1	SECOND
EVENT REFRESH TIME					1	SECOND

PREVIOUS
Ch-01 ~ ch-04
NEXT

SAVE
DEFAULT
CANCEL

- No.: Click to popup Copy Setting box.
- Type : Set external sensor input NO/NC/Off for each camera.
- Beep : Set beeping sound On / Off.
- Alarm-Out : Set Alarm-Out On / Off in case sensor input is detected.
- Duration : Set dwell time from 1 to 99 seconds.
- Event Refresh Time : Set interval time from 1 to 99 seconds.
- Previous : Go to previous channel page.
- Next : Go to next channel page.

*N.O = Normal Open Type
 *N.C = Normal Close Type

[2] Motion

1) Setup

Set Motion Detection for each channel.

SETUP		ACTION		
NO.	TYPE	BEEP	SENSITIVITY	MASK ZONE
01	ON	OFF	VERY HIGH	SELECT
02	ON	OFF	VERY HIGH	SELECT
03	ON	OFF	VERY HIGH	SELECT
04	ON	OFF	VERY HIGH	SELECT
ZONE VIEW		OFF	DETECT CELL NUMBER	10
PREVIOUS		Ch-01 ~ Ch-04		NEXT
SAVE		DEFAULT		CANCEL

- No.: Click to popup Copy Setting box.
- Type : Set motion mask On/Off for each channel.
- Beep : Set beeping sound On / Off in case preset event occurs.
- Sensitivity : Set sensitivity among Very High, High, Standard, Low & Very Low.
- Mask Zone : Click to go to Motion Mask Zone setup window.
- Zone View : Motion detected cells will be displayed in red.
- Detect Cell Number : Set number of cells for Mask Zone from 1 to 180.
Only when more cells than set Detect Cell number detect motion, it will start Motion detection.
- Previous : Go to previous channel page.
- Next : Go to next channel page.

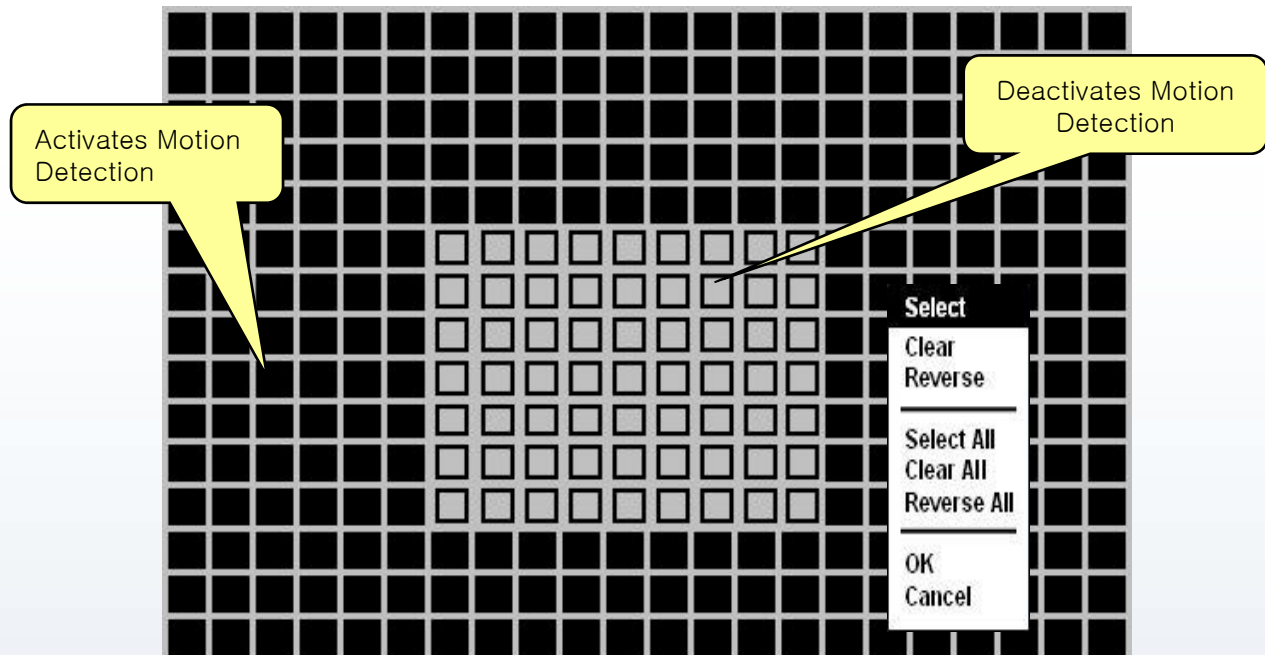
Motion Mask Zone setup window**- Cell Setup**

Click left button of mouse to set Motion Mask Zone by selecting or clearing blocks.

- Block Setup

Click selected cell and drag it to desired position. All cells within the block will be selected.

Select: Deactivate motion detection.

Clear: Activate motion detection.

Reverse: Activate inactive blocks and deactivate active blocks.

- Click OK on the popup menu to save setting and exit.

2) Action

Set Alarm-Out On / Off for each channel in case motion is detected.

SETUP	ACTION				
NO.	ALARM-OUT		DURATION		
01	1 <input type="checkbox"/>	2 <input type="checkbox"/>	10	SECOND	
02	1 <input type="checkbox"/>	2 <input type="checkbox"/>	10	SECOND	
03	1 <input type="checkbox"/>	2 <input type="checkbox"/>	10	SECOND	
04	1 <input type="checkbox"/>	2 <input type="checkbox"/>	10	SECOND	
EVENT REFRESH TIME			1	SECOND	
PREVIOUS		Ch-01 ~ Ch-04		NEXT	
SAVE		DEFAULT		CANCEL	

- No.: Click to popup Copy Setting box.
- Alarm-Out : Set On / Off for sending alarm signal to relay output terminal.
- Duration : Set alarm dwell time from 1 to 99 seconds.
- Event Refresh Time : Set interval from 1 to 99.

[3] Video Loss

Setup reacting to video loss for each camera

VIDEO LOSS					
NO.	BEEP	ALARM-OUT		DURATION	
01	On	1 <input type="checkbox"/>	2 <input type="checkbox"/>	1	SECOND
02	On	1 <input type="checkbox"/>	2 <input type="checkbox"/>	1	SECOND
03	On	1 <input type="checkbox"/>	2 <input type="checkbox"/>	1	SECOND
04	On	1 <input type="checkbox"/>	2 <input type="checkbox"/>	1	SECOND
EVENT REFRESH TIME				1	SECOND
PREVIOUS		Ch-01 ~ Ch-04		NEXT	
SAVE		DEFAULT		CANCEL	

- No.: Click to popup Copy Setting box.
- Beep : Beep On/Off in case of Video loss.
- Alarm-Out : Send signal via Relay Out terminal.
- Duration : Dwell time from 1 to 99 seconds.
- Event Refresh Time : Set interval from 1 to 99.

[4] Alarm-Out

1) Setting

SETTING
SCHEDULE

DURATION SECOND

- Duration : Output dwell time for Alarm-Out set from Alarm/Motion/Loss from 1 to 99 seconds.

2) Schedule

SETTING
SCHEDULE

NO.	DAY	START TIME		END TIME		MODE	OUT1	OUT2
1	MONDAY	03	13	03	17	ON	1 <input checked="" type="checkbox"/>	2 <input checked="" type="checkbox"/>
2	MONDAY	03	03	04	03	EVENT	1 <input checked="" type="checkbox"/>	2 <input checked="" type="checkbox"/>
3	MONDAY	03	23	06	03	EVENT	1 <input checked="" type="checkbox"/>	2 <input checked="" type="checkbox"/>
4	MONDAY	01	03	03	03	OFF	1 <input checked="" type="checkbox"/>	2 <input checked="" type="checkbox"/>
5	MONDAY	02	03	03	03	OFF	1 <input checked="" type="checkbox"/>	2 <input checked="" type="checkbox"/>
6	MONDAY	00	00	00	00	EVENT	1 <input checked="" type="checkbox"/>	2 <input checked="" type="checkbox"/>
7	MONDAY	00	00	00	00	EVENT	1 <input checked="" type="checkbox"/>	2 <input checked="" type="checkbox"/>
8	MONDAY	00	00	00	00	EVENT	1 <input checked="" type="checkbox"/>	2 <input checked="" type="checkbox"/>

- Day : Select day of a week for output among All, Monday ~ Sunday, Weekday, and Weekend.
- Start Time : Select start time for output.
- End Time : Select end time to end output.
- Mode : Select mode among Event, On, and Off.
 - Event : On in case of Alarm or Motion
 - On : Always On, regardless of Event
 - Off : Always OFF, regardless of Event.
- Out1 : Mark checkbox to send signal to relay output terminal 1 (Pin 5).
- Out2 : Mark checkbox to send signal to relay output terminal 2 (Pin 6).

[5] Buzzer

Select Buzzer On/Off.

BUZZER

KEY BEEP	ON
VIDEO LOSS	ON
ALARM-IN	ON
MOTION DETECT	ON

SAVE

DEFAULT

CANCEL

- **Key Beep** : Set On/Off in case mouse or keyboard panel is pressed.
- **Video Loss** : Set On/Off in case of Camera Loss.
- **Alarm-In** : Set On/Off in case external sensor input is detected.
- **Motion Detect** : Set On/Off in case motion is detected.

If Buzzer Menus are Off, buzzer will not be activated even Alarm/Motion/Loss Menus are On.

5-5. Network

1] LAN

1) Ethernet

Setup to enable viewing live screen or searching/backup recorded data on HDD remotely over the network.

ETHERNET	DDNS	TRANSMISSION	
MAC ADDRESS	00 - 0A - A2 - 0B - 08 - 83		
IP TYPE	DYNAMIC	DHCP	
IP ADDRESS	24	106	001 195
PORT	50000		
WEBSERVER	<input type="checkbox"/>	80	
GATEWAY	24	106	001 193
SUBNET	255	255	255 240
STATUS	2008/04/23 17:07:37		
SAVE		DEFAULT	
		CANCEL	

[Dynamic IP Type]

-**MAC Address** : See if MAC address starts with "00-0A-A2 ...".

-**IP Type** : If Dynamic IP is selected, only IP Port can be set, and if Static IP is selected, you can setup all values. When Dynamic IP is selected, DHCP button will be activated.

Press DHCP button, and when connection is successful, current time will show on Status box.

-**IP Address** popup : In case of Static IP Type IP address input window pops up.

- **Port** : Port setup is from 10 to 65000. In case of block from firewall, contact your network administrator.

-**WEBSERVER** : Checkbox - WEBSERVER function ON/OFF.

: Number : WEBSERVER PORT number.

If the number is 90, connect to <http://24.106.1.195:90/>.

-Gateway popup : In case of Static IP Type Gateway input window pops up.

-Subnet popup : In case of Static IP Type Subnet mask address input window pops up.

2) DDNS

Set DDNS Server Connection.

ETHERNET	DDNS	TRANSMISSION
DDNS ON/OFF	<input type="text" value="OFF"/>	
DDNS SERVER	<input type="text" value="STATIC IP"/>	
	<input type="text" value="211"/>	<input type="text" value="062"/>
	<input type="text" value="263"/>	<input type="text" value="088"/>
	<input type="text" value="0080"/>	
DVR ID	<input type="text" value="SDVR16CH"/>	
UPDATE INTERVAL	<input type="text" value="10"/>	MINUTE
LAST UPDATE	<input type="text" value="--/-- --:--:--"/>	
<input type="button" value="SAVE"/> <input type="button" value="DEFAULT"/> <input type="button" value="CANCEL"/>		

- **DDNS On/Off** : Select On to enable, Off to disable.
- **DDNS Server** : Input server domain name address.
Input server domain name, or select Static IP to input IP address manually.
- **PORT** : In case of firewall, contact your network administrator.
Port setup is from 10 to 65000. (Port provided from DDNS Server : 80), (Currently, Port is able to use only 80.)
- **DVR ID** : Input DVR ID for DDNS server. DDNS may not work if ID is duplicated.
- **Update Interval** : Interval of updating DVR IP information to DDNS server.
Interval can be set to 5,10,15,30,45,60, 120 minutes.
- **Last Update** : Displays time of last update to DDNS server. (YY/MM/DD HH:MM:SS)

3) Transmission

Image of selected channel will be transmitted to Viewer of IRS.

Ethernet	DDNS	Transmission					
Select Transmission Channel							
CH1	<input type="checkbox"/>	CH2	<input type="checkbox"/>	CH3	<input type="checkbox"/>	CH4	<input type="checkbox"/>
CH5	<input type="checkbox"/>	CH6	<input type="checkbox"/>	CH7	<input type="checkbox"/>	CH8	<input type="checkbox"/>
CH9	<input type="checkbox"/>	CH10	<input type="checkbox"/>	CH11	<input type="checkbox"/>	CH12	<input type="checkbox"/>
CH13	<input type="checkbox"/>	CH14	<input type="checkbox"/>	CH15	<input type="checkbox"/>	CH16	<input type="checkbox"/>
<input type="button" value="Save"/> <input type="button" value="Default"/> <input type="button" value="Cancel"/>							

Default setting is all channels selected.

[2] Notification

1) Setting

SETTING	EMAIL	EVENT
RETRY COUNT	<input type="text" value="10"/>	
SEND INTERVAL	<input type="text" value="10"/>	MINUTE
	<input type="text" value="10"/>	EVENT COUNT
SEND CONDITON		
ALARM	<input type="checkbox"/>	
MOTION	<input type="checkbox"/>	
VIDEO LOSS	<input type="checkbox"/>	
PANIC	<input type="checkbox"/>	
<input type="button" value="SAVE"/> <input type="button" value="DEFAULT"/> <input type="button" value="CANCEL"/>		

Set notification for both e-mail and event server. See Chapter 7-9 [4] for details

- **Retry Count** : Number of times of retrial (Set from 1~30)
- **Send Interval** : Send information either when set time expires or when number of event reaches set number.
- **Send Condition** : Send information for the selected event to e-mail or Event server.

2) EMAIL

SETTING	EMAIL	EVENT
SEND E-MAIL ON/OFF	<input type="text" value="ON"/>	
SEND SERVER IP	<input type="text" value="210"/> <input type="text" value="126"/> <input type="text" value="014"/> <input type="text" value="160"/>	
SEND PORT	<input type="text" value="80"/>	
AUTHENTICATION	<input type="checkbox"/>	
SEND SERVER ID	<input type="text" value="SDVR"/>	
SEND SERVER PW	<input type="text" value="****"/>	
SENDER	<input type="text" value="hotmail.com"/>	
RECIPIENT	<input type="text" value="sdvr@hotmailcom"/>	
<input type="button" value="SAVE"/> <input type="button" value="DEFAULT"/> <input type="button" value="CANCEL"/>		

- **Send E-mail On/Off** : Select on to enable, Off to disable
- **Send Sever IP** : Enter the SMTP server IP.
- **Send Port**: Enter the SMTP server port number obtained from your system administrator. Set send server port number from 10 to 65000. Contact mail server administrator.
- **Authentication**: Check checkbox for authentication to mail server. Authenticate ID/PW for send mail server. Enter authentication ID/PW on the below SEND SERVER ID and SEND SERVER PW.
- **Send Sever ID** : Enter the e-mail user ID using the virtual keyboard.
- **Send Sever PW** : Enter the e-mail PW using the virtual keyboard.
- **Sender** : Enter the sender's e-mail address.
- **Recipient** : Enter the recipient's e-mail address.

3) Event

DVR can be set to send events to CMS (Central Management Software) program.
See Chapter 7-9 [5] Event for more details.

SETTING		EMAIL		EVENT			
No.	ACTIVE	IP ADDRESS				PORT	
1	<input checked="" type="checkbox"/>	192	168	001	72	09988	
2	<input checked="" type="checkbox"/>	192	168	001	72	09988	
3	<input checked="" type="checkbox"/>	192	168	001	72	09988	
4	<input checked="" type="checkbox"/>	192	168	001	72	09988	

SAVE DEFAULT CANCEL

- **Active** : Check checkbox to activate.
- **IP address** : Shows IP address of the PC, in which event server program runs.
- **Port** : Shows Port of the PC, in which event server program runs.
Port setup is from 10 to 65000.

5-6. System

[1] Information

Information	
LANGUAGE	ENGLISH ◀ ▶
VERSION	0.49.46 UPGRADE SW
Setup	IMPORT SETUP EXPORT SETUP
	DEFAULT ALL
	SHOW SYSTEM LOG
HDD 1	<input checked="" type="checkbox"/> WDC WD2000JS-00NCB1, 186 GB
HDD 2	<input type="checkbox"/>
CD/DVD WRITER	<input checked="" type="checkbox"/> TSSTcorpCD/DVDW TS-H652D
Exit	

- **Language** : Set language of System Menu among English, French, Spanish, Italian, Portuguese, Dutch, Russian, German, Turkish and Polish.
- **Version** : Current firmware version.
- **Upgrade SW** : Update current firmware.
- **Import Setup** : Bring setup values saved from USB storage.
You can apply same setup value of a DVR to other DVRs easily.
- **Export Setup** : Save current setup value to USB storage.
- **Default All** : Factory default for all menus. (See chapter10 for factory default values)
If you run Default All, Time/Date and Password will all be defaulted.
After Default All, set time/date and clear HDD for normal operation.
- **Show System Log** : Show list of Start/End time of Panic Recording, Start/End time of Schedule recording, and WHO/WHEN logged in.
- **HDD1, HDD2** : Display Manufacturer/Size of HDD.
- **CD WRITER** : Display Manufacturer of CD-RW.
- **HDD1, HDD2, CD/DVD Writer Checkbox** : Check checkbox to request information of connected device. If checkbox is not checked, it skips detection to reduce booting time.

UPGRADE SW

STORAGE STATUS	CHECKING USB MEDIA
UPGRADE FILE	
INFORMATION	

Click Upgrade SW button, and pop-up box appears.

- Storage Status : Shows firmware update progress. (See chapter 11 for warning and error messages).
- Upgrade File : Name of file to upgrade.
- Information : Shows error code in case of error.

Recording will stop while upgrading.

IMPORT SETUP

STORAGE STATUS	CHECKING USB STORAGE...
FILE NAME	
INFORMATION	

Click Import Setup button, and import window pops up.

- File Name : Show name of the file in USB which contains setup value.
- Information : Shows error code in case of error.

EXPORT SETUP

STORAGE STATUS	CHECKING USB STORAGE...
FILE NAME	SDVR_16CH_2008_01_18_14_24_
INFORMATION	

Click Export Setup button to save DVR's setup value to USB.

- Export : Save export setup value to USB.

Shows list of Start/End time of Panic Recording, Start/End time of Schedule recording, and WHO/WHEN logged in/out.

SYSTEM LOG

DATE/TIME	EVENT INFORMATION
2008/03/11 17:42:48	Login admin
2008/03/11 17:42:47	Menu start
2008/03/11 17:42:36	Schedule record start
2008/03/11 17:42:26	Schedule record start
2008/03/11 17:23:31	Menu exit
2008/03/11 17:18:04	Menu start
2008/03/11 17:16:20	Menu exit
2008/03/11 17:12:11	Panic record start

000001/000064 ▲ ▼

- Date/Time : Date and time of event.
- Event Information : Event type (Panic record start/stop, Schedule record start/stop, HDD full record stop, etc) See chapter 11 for more details.
- Page box : Current page / Total pages (maximum 2,048 pages).
You can type in page number directly.
- Up button : Goto previous page.
- Down button : Goto next page.

[2] Date / Time

1) Date / Time

Set Date/Time of system.

DATE/TIME	HOLIDAY	TIME SYNC
DATE	2007	12 10
TIME	19	22 18
DATE FORMAT	2007/12/10	
MONTH FORMAT	12	TIME FORMAT 19
TIME ZONE	(GMT+09:00) Seoul	
USE DST	<input type="checkbox"/>	
<div style="display: flex; justify-content: space-around; margin-top: 10px;"> SAVE DEFAULT CANCEL </div>		

- **Date** : Set Year, Month, Day. Year can be set from 2008 to 2099.
- **Time** : Set Hour, Minute, Second.
- **Date Format** : Choose date format among YY/MM/DD, MM/DD/YY and DD/MM/YY.
- **Month Format** : Choose month format between numbers and letters.
- **Time Format** : Choose 12-hour mode (am./pm.) or 24-hour-mode.
- **Time Zone** : Select area zone, and input current time.
(GMT+09:00) Seoul → GMT standard time + 09:00 = Time of Seoul, Korea.
- **Use DST checkbox** : Check box for Daylight Saving Time (=Summer Time).

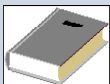

<Note>

- Time cannot be defaulted.
- Do not set time earlier than the time of the last recorded data.
- On initial setup, after default all, be sure to format HDD after setting up time/date.

2) Holiday

Set national holidays or holidays on calendar to record as setting for Sunday in Schedule Record Setup.

DATE/TIME	HOLIDAY	TIME SYNC	
No.	MONTH	DAY	<input type="checkbox"/>
001			<input type="checkbox"/>
002			<input type="checkbox"/>
003			<input type="checkbox"/>
004			<input type="checkbox"/>
005			<input type="checkbox"/>
◀ 01/01 ▶	ADD	DELETE	
SELECT DAY OF WEEK		SUNDAY	
SAVE		DEFAULT	
CANCEL			

- **Add** : Click add button and today's month and day will be added on the screen.
Click month and day to change the date of the holiday.
- **Delete** : Delete list, checkbox of which is marked.
- **Select day of week**: Set selected day of week as holiday. (Default is Sunday)
- **No/No**: Current Page/Total Pages
- **Left arrow button** : Previous page.
- **Right arrow button** : Next page.
- **Checkbox** : Check box of the date to delete. Press Delete button to delete selected date.



<Note>

- **Up to 100 days** can be set as holiday.
- **Holidays that do not fall on the same date each year** should be updated once the current year's holiday has passed.

3) Time Sync

SYSTEM LOG	HOLIDAY	TIME SYNC	
AUTOMATIC SYNC	<input type="text" value="OFF"/>		
TIME SERVER	<input type="text" value="211"/>	<input type="text" value="048"/>	<input type="text" value="062"/>
RETRY COUNT	<input type="text" value="01"/>		
INTERVAL	<input type="text" value="0.5"/>	HOUR	
LAST SYNC-TIME	<input type="text" value="2000/00/00 00:00:00"/>		
<input type="button" value="SAVE"/> <input type="button" value="DEFAULT"/> <input type="button" value="CANCEL"/>			

- **Automatic Sync** : Choose between On/Off.
- **Time Server** : Input sync server IP address (SNTP).
- **Retry Count** : Select from 1 to 30 retries.
- **Interval** : Automatic Sync Interval (0.5, 1, 2, 3, 4, 5, 6, 12, 24 hours)
- **Last Sync Time** : Shows time of Last Sync.

[3] Storage

Shows HDD total capacity, start time/end time of recorded data and can format HDD.

Information	
TOTAL CAPACITY	<input type="text" value="211GB [68GB, 143GB]"/>
USED SPACE	<input type="text" value="0 GB"/>
USED PERCENT	<input type="text" value="0 %"/>
RECORDED VIDEO INFORMATION	
STAR TIME	<input type="text" value="2008/02/20 10:24:45"/>
END TIME	<input type="text" value="2008/02/20 10:24:25"/>
RECORDED TIME	<input type="text" value="1"/> DAY
AUTO DELETION	<input type="text" value="1"/> DAY
<input type="button" value="FORMAT"/> <input type="button" value="EXIT"/>	

- **Total Capacity** : Shows total size of HDD [size of HDD1, size of HDD2]
- **Used Space** : Shows total size of recorded image data.
- **Used Percent** : Shows the percentage of recorded image data.
- **Start Time** : Shows start time of recorded data on HDD.
- **End Time** : Shows end time of recorded data on HDD.
- **Recorded Time** : Total number of days from Start Time till End Time.
- **Auto Deletion** : Store recorded data of designated duration (0~99days)
The data over the designated duration is automatically deleted.
- **Format** : Format HDD.

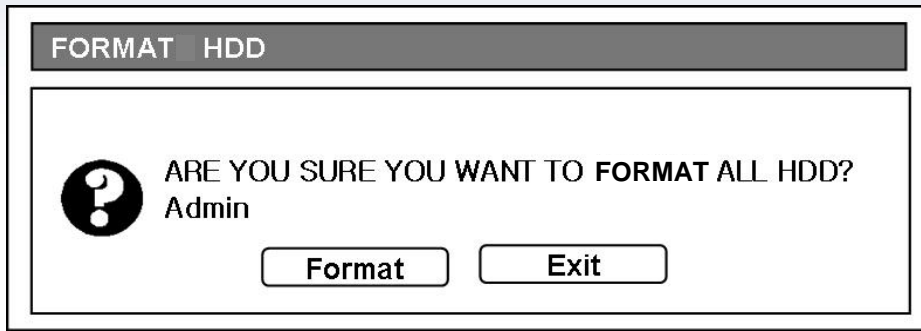

When format button is pressed, new window pops up to confirm. Press Format button again to begin clear HDD.

[4] User

Set password for each user grade or check Auto Login checkbox for auto Login.

- **User** : Choose from admin, manager, user 1 ~ user 8.

- **Password** : Set password for each user grade.
(Maximum 8 characters.)

- **Authority** : Admin can set authority to access to setting menu for each user grade.

- **Auto Login** : Logs in automatically to setup menu without asking User and Password when turning the DVR power on.

- **Auto Logout** : Logs out automatically when certain time passes.
Time can be set to 1, 2, 3, 4, 5, 10 minutes.

If you click Password, Change Password message box pops up. Click Current Password, Current Password message box pops up. Password is from 1 digit to 8 digit number.

CHANGE PASSWORD

CURRENT PASSWORD

NEW PASSWORD

CONFIRM PASSWORD

CURRENT PASSWORD

0	1	2	3	4	5
6	7	8	9	↩	X

Click Authority button and Authority Setup window pops up.
Set authority to access for each user grade.

AUTHORITY SETUP

UPGRADE SW <input checked="" type="checkbox"/>	DEVICE <input checked="" type="checkbox"/>
FORMAT HDD <input checked="" type="checkbox"/>	RECORD <input checked="" type="checkbox"/>
CHANGE SYSTEM TIME <input checked="" type="checkbox"/>	SCHEDULE <input checked="" type="checkbox"/>
IMPORT SETUP <input checked="" type="checkbox"/>	PRE-EVENT <input checked="" type="checkbox"/>
SHOW SYSTEM LOG <input checked="" type="checkbox"/>	BACKUP <input checked="" type="checkbox"/>
CHANGE USER SETUP <input checked="" type="checkbox"/>	EVENT <input checked="" type="checkbox"/>
NETWORK <input checked="" type="checkbox"/>	PLAYBACK <input checked="" type="checkbox"/>
CAMERA <input checked="" type="checkbox"/>	PTZ CAMERA <input checked="" type="checkbox"/>
ALARM-OUT <input checked="" type="checkbox"/>	NETWORK ACCESS <input checked="" type="checkbox"/>

Check checkbox of contents for Manager & User menu.
Corresponding user grade will have authority to access setting menu as checked.
Only Admin can mark checkbox.

[5] Logout

1) Warning message box

When Logout is selected from [Menu] → [System] → [Logout], warning message box pops up as below.

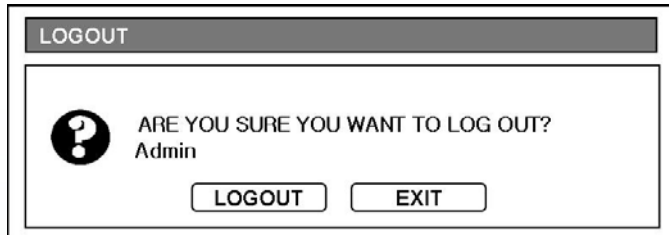

- If you press Logout button from the message box, the device will not remember current user ID, and in order to Login to system menu again, system login window will pop up again.

CHAPTER 6. Search

It is to search data recorded in various modes (Schedule, Event, Continuous) easily and playback.

Search by Calendar, Event list and Bookmark is available.

Pressing right button of mouse will popup MONITORING popup window, and click Search.
Or press [SEARCH] button to enter into Search menu.

6-1. Calendar Search

Recorded data displays in calendar Search.

CALENDAR SEARCH		EVENT SEARCH		BOOKMARK SEARCH			
<<		2008 - 01				>>	
SUN	MON	TUE	WED	THU	FRI	SAT	
		1	2	3	4	5	
6	7	8	9	10	11	12	
13	14	15	16	17	18	19	
20	21	22	23	24	25	26	
27	28	29	30	31			
GOTO		2008-01-01	00	00	00		
PREVIEW		PLAYBACK		EXIT			

- << Shows previous month.

- >> Shows next month.

-Goto Date, Time

- Goto 1st box : Shows date in YY-MM-DD format to search.

- Goto 2nd box : Shows Hour to search. Change Hour from 0~23 by clicking the box.

- Goto 3rd box : Shows Minute to search. Change Minute from 0~59 by clicking the box.

- Goto 4th box : Shows Second to search. Change Second from 0~59 by clicking the box.

- Preview : Playback for 10 seconds from the set date/time and return to calendar search.

- Playback : Playback from the set date/time.

- **Exit** : Exit search menu.

* Year can be set from 2007 to 2099.(Years with recorded data can be changed.)

Days with recorded data display on the calendar with white numbers. Click the number, and information of selected date and time appears as below.

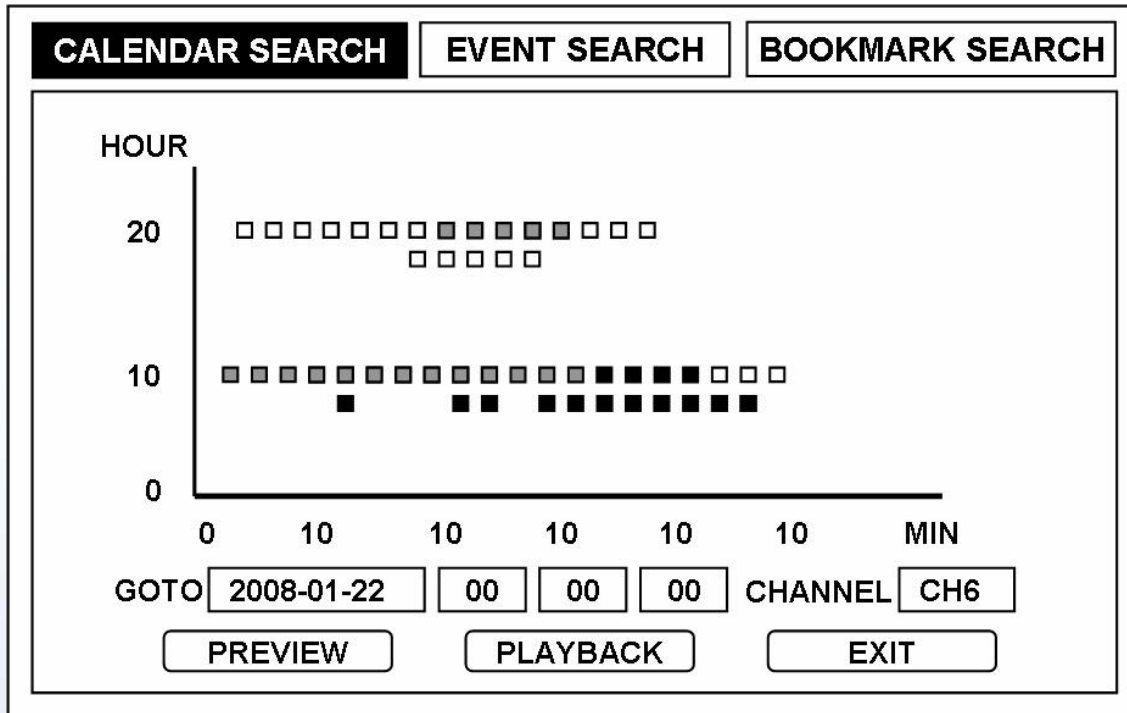

- If dots are white, it means it contains recorded data. If dots are black, there's no recorded data.
- Select white dot, or input time in 'Goto' box, and press Preview / Playback to begin playback.
- When white dot is selected, Hour/Minute on the 'Goto' boxes change automatically, but user should input second manually.
- Date box : By clicking this box, you can move to Calendar search menu, where you can set date.
- Channel : In case ALL is selected :

White cubic contain recorded data.

Small Dots doesn't contain recorded data.

In case certain channel number is selected:

Red cubic contain recorded data for alarm-in recording. (Alarm Only)

Blue cubic contain recorded data for time recording.

Green cubic contain recorded data for motion recording (Motion Only)

Black cubic contain recorded data for panic recording

Pink cubic contain recorded data for motion + time recording

Yellow cubic contain recorded data for alarm + motion recording

Cyan cubic contain recorded data for alarm + time recording

Small Dots doesn't contain recorded data.

*1 dot/cubic is 1 minute.

6-2. Event Search

Recorded data for Event (Motion, Alarm, Loss, Panic) displays in Event Search.

CALENDAR SEARCH	EVENT SEARCH	BOOKMARK SEARCH																																																											
<table border="1" style="margin: auto; border-collapse: collapse;"> <tr> <td style="width: 10%; text-align: center;"><<</td> <td style="width: 80%; text-align: center;">2008 - 01</td> <td style="width: 10%; text-align: center;">>></td> </tr> <tr style="background-color: black; color: white;"> <th style="width: 14.28%;">SUN</th> <th style="width: 14.28%;">MON</th> <th style="width: 14.28%;">TUE</th> <th style="width: 14.28%;">WED</th> <th style="width: 14.28%;">THU</th> <th style="width: 14.28%;">FRI</th> <th style="width: 14.28%;">SAT</th> </tr> <tr> <td></td> <td></td> <td style="text-align: center;">1</td> <td style="text-align: center;">2</td> <td style="text-align: center;">3</td> <td style="text-align: center;">4</td> <td style="text-align: center;">5</td> </tr> <tr> <td style="text-align: center;">6</td> <td style="text-align: center;">7</td> <td style="text-align: center;">8</td> <td style="text-align: center;">9</td> <td style="text-align: center;">10</td> <td style="text-align: center;">11</td> <td style="text-align: center;">12</td> </tr> <tr> <td style="text-align: center;">13</td> <td style="text-align: center;">14</td> <td style="text-align: center;">15</td> <td style="text-align: center;">16</td> <td style="text-align: center;">17</td> <td style="text-align: center;">18</td> <td style="text-align: center;">19</td> </tr> <tr> <td style="text-align: center;">20</td> <td style="text-align: center;">21</td> <td style="text-align: center;">22</td> <td style="text-align: center;">23</td> <td style="text-align: center;">24</td> <td style="text-align: center;">25</td> <td style="text-align: center;">26</td> </tr> <tr> <td style="text-align: center;">27</td> <td style="text-align: center;">28</td> <td style="text-align: center;">29</td> <td style="text-align: center;">30</td> <td style="text-align: center;">31</td> <td></td> <td></td> </tr> <tr> <td></td> <td></td> <td></td> <td></td> <td></td> <td></td> <td></td> </tr> <tr> <td></td> <td></td> <td></td> <td></td> <td></td> <td></td> <td></td> </tr> </table>			<<	2008 - 01	>>	SUN	MON	TUE	WED	THU	FRI	SAT			1	2	3	4	5	6	7	8	9	10	11	12	13	14	15	16	17	18	19	20	21	22	23	24	25	26	27	28	29	30	31																
<<	2008 - 01	>>																																																											
SUN	MON	TUE	WED	THU	FRI	SAT																																																							
		1	2	3	4	5																																																							
6	7	8	9	10	11	12																																																							
13	14	15	16	17	18	19																																																							
20	21	22	23	24	25	26																																																							
27	28	29	30	31																																																									
<p>FIRST <input style="width: 80%;" type="text" value="2008/01/15 02:40:23"/></p> <p>LAST <input style="width: 80%;" type="text" value="2008/01/22 09:40:23"/></p>																																																													
<table style="width: 100%; margin: auto;"> <tr> <td style="width: 33%; text-align: center; border: 1px solid black; padding: 5px;">PREVIEW</td> <td style="width: 33%; text-align: center; border: 1px solid black; padding: 5px;">PLAYBACK</td> <td style="width: 33%; text-align: center; border: 1px solid black; padding: 5px;">EXIT</td> </tr> </table>			PREVIEW	PLAYBACK	EXIT																																																								
PREVIEW	PLAYBACK	EXIT																																																											

- << Shows previous month.

- >> Shows next month.

First : Date/Time of the first event recorded.

Last : Date/Time of the last event recorded.

- **Exit** : Exit search menu.

Click date from the calendar, and event list of the day will display.

* Year can be set from 2008 to 2099.(Years with recorded data can be changed.)

Click Time of event you wish to see and click PREVIEW or PLAYBACK.

CALENDAR SEARCH
EVENT SEARCH
BOOKMARK SEARCH

NO.	TIME	ALL TYPE	CHANNEL
1	2008-02-27 02:37:22	MOTION	
2	2008-02-27 02:37:48	ALARM	1
3	2008-02-27 02:37:49	MOTION	
4			
5			
6			
9			
8			

PREVIOUS
1 / 1
NEXT
DELETE

PREVIEW
PLAYBACK
EXIT

- All Type : Event selection among All Type, Motion, Alarm, Loss, and Panic.
List of selected event will be shown.
- Channel : Channel selection among All, 1ch~16ch.
List of selected channel will be shown.
- Return : Return to first page of calendar menu of the event search.
- Previous : Shows previous page.
- Next : Shows next page.
- Preview : Starts playback from set time for 10 seconds and return to Event Search Menu.
- Playback : Starts playback from set time.
- Exit : Exit search menu.

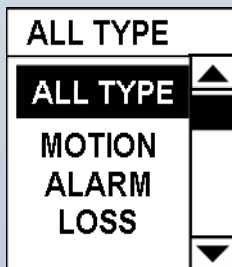

Click All Type button and you can choose a certain event type to be listed from scroll box.

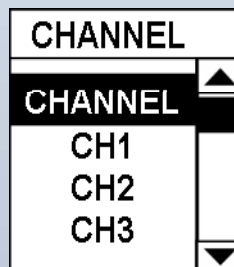

Click Channel button and you can choose a certain channel to be listed from the scroll box.

6-3. Bookmark Search

The Bookmark search screen displays a list of the video associated with bookmark in the playback mode.

CALENDAR SEARCH	EVENT SEARCH	BOOKMARK SEARCH	
NO.	TIME	LOGIN	DELETE
1	2008-02-27 02:37:22	ADMIN	<input type="checkbox"/>
2	2008-02-27 02:37:48	ADMIN	<input type="checkbox"/>
3	2008-02-27 02:37:49	ADMIN	<input type="checkbox"/>
4			<input type="checkbox"/>
5			<input type="checkbox"/>
6			<input type="checkbox"/>
9			<input type="checkbox"/>
8			<input type="checkbox"/>

- **Time** : Shows time of the bookmarked list.
- **Login** : Shows user grade who bookmarked the list.
- **Delete Checkbox** : Check box of the list to delete.
- **Preview** : Starts playback from set time for 10 seconds and return to Calendar Search Menu.
- **Playback** : Starts playback from set time.
- **Previous** : Shows previous page.
- **Next** : Shows next page.
- **Exit** : Exit search menu.

* Up to 48 bookmarks can be listed. (24 by Admin, and other 24 by Manager)

CHAPTER 7. DVR OPERATION

7-1 Live Monitoring

Once DVR completes its initialization, live screen displays on connected monitor with live audio through connected speaker. Default mode is displaying all connected camera channels at once. Pressing a certain camera channel button will switch display to full screen mode of the camera channel. This mode continues unless other mode is selected. Press [MODE] button to switch to other display formats.

From MONITORING popup menu, 1, 4, 9, 16 split display mode is available, and by pressing [MODE] button on the front panel, 1, 4, 6, 8, 9, 13, 16 split display mode is available.

PIP, Zoom, FRZ, Sequence will not function while in Playback mode.

1] PIP

When [PIP] button is pressed, one channel displays on the full monitor screen while another small screen displays in inset window in sequence.

Set sequence interval from [MENU]-[Display]-[Display]-[Main]-[Sequence Interval].

Press [PIP] button again or switch to other display format to exit PIP mode.

While in PIP mode, PTZ Control, Freeze, Zoom, Sequence will not function.

2] Zoom

Press [ZOOM] button to zoom in x2. Press the button again or switch to other display format to return to normal size. Move selected frame by mouse control or arrow keys.

Zoom function is available only in full screen mode.

While in zoom mode, PTZ Control, Freeze, Sequence, PIP will not function.

3] FRZ

Press [FRZ] button to freeze image. Press the button again or switch to other display format to exit freeze mode.

While in FRZ mode, PIP, Zoom, Sequence, PTZ Control will not function

4] Sequence

While in full screen mode, press [SEQ] button to cause channel of connected cameras to display sequentially according to the preset dwell time.

Access [MENU]-[Display]-[Display]-[Main]-Sequence Interval Popup for dwell time setup.

Access [MENU]-[Display]-[Display]-[Main]-Sequence Mode Popup for channel display mode.

Press the button again or switch to other display format to exit sequence mode.

While in sequence mode, PTZ Control, Freeze, Zoom, PIP will not function.

	Freeze	Zoom	Sequence	PIP
1 full screen mode	O	O	O	O
4 split ~ 13 split display mode	O	X	O	X
16 split display mode	O	X	X	X
In playback mode	X	X	X	X
Setup root	X	X	Menu → Display → Display → Main → Sequence Mode / Sequence Interval	Setup Menu → Display → Display → Main → Sequence Interval

5] PTZ

User with PTZ Control Authority can control PTZ cameras.

(Access [Menu]-[System]-[User]-Authority and check checkbox for user authority for PTZ control)

Access [Menu]-[Display]-[Camera]-[PTZ] to setup PTZ model, PTZ ID, and Baud rate.

MONITORING
GOTO CHANNEL SPLITTER
PTZCONTROL FREEZE ZOOM SEQUENCE PIP AUDIO PANIC
PLAYBACK SEARCH SETUP MENU

[In split screen mode]

MONITORING
GOTO CHANNEL SPLITTER
PTZCONTROL FREEZE ZOOM SEQUENCE PIP AUDIO PANIC
PLAYBACK SEARCH SETUP MENU

[In full screen mode]

Mouse popup menu for PTZ control will be activated only when in full screen mode.

For PAN left and right, press [LEFT] and [RIGHT] buttons, and for TILT up and down, press [UP] and [DOWN] buttons. For ZOOM IN, press [Wide] button, and for ZOOM OUT, press [Tele] button. For focusing, press [NEAR] or [FAR] buttons.

Button	Function	Button	Function
1 / TELE	ZOOM IN	11 / GOTO	GOTO PRESET
2 / WIDE	ZOOM OUT	12 / AUTO	AUTO SCAN
3 / NEAR	FOCUS NEAR	↑	TILT UP
4 / FAR	FOCUS FAR	↓	TILT DOWN
5 / ON	POWER ON	←	PAN LEFT
6 / OFF	POWER OFF	→	PAN RIGHT
7 / OPEN	IRIS OPEN	↑ ←	PAN LEFT/TILT UP
8 / CLOSE	IRIS CLOSE	↑ →	PAN RIGHT/TILT UP
9 / SET	SET PRESET	↓ ←	PAN LEFT/TILT DOWN
10 / CLEAR	CLEAR PRESET	↓ →	PAN RIGHT/ TILT DOWN

PTZ CONTROL

SELECT CHANNEL

GOTO PRESET
SET PRESET
CLEAR PRESET

TOUR
PATTERN
AUTO PAN
POWER
LIGHT
WIPER
PUMP

DEVICE MENU
EXIT PTZ CONTROL

Set preset position for PTZ cameras. Press [SET PRESET] button or click Set Preset from PTZ Control popup menu.

PTZ CONTROL

SELECT CHANNEL

GOTO PRESET
SET RESET
CLEAR PRESET

TOUR
PATTERN
AUTO PAN
POWER
LIGHT
WIPER
PUMP

DEVICE MENU
EXIT PTZ CONTROL

- Position 1
- Position 2
- Position 3**
- Position 4
- Position 5
- Position 6
- Position 7
- Position 8
- Position 9
- Position 10

By setting the position of cameras, user can view the area of preset position of cameras easily. When camera is in desired position, click Set Preset button, and Position selection menu pops up. Click the number to assign the position. To load the Preset, click Goto Preset button, and Position selection menu pops up. Click the number of position, and the camera will automatically move to the preset position.

PTZ CONTROL

SELECT CHANNEL

GOTO PRESET
SET RESET
CLEAR PRESET

TOUR
PATTERN
AUTO PAN
POWER
LIGHT
WIPER
PUMP

DEVICE MENU
EXIT PTZ CONTROL

Please refer to the user's manual for cameras, or contact manufacturer of cameras for proper settings. Some functions may not be supported, depending on the detailed specification of cameras.

Easy PTZ control with mouse operation:
 With virtual joystick, user can control PAN left/right, TILT up, down with mouse operation.

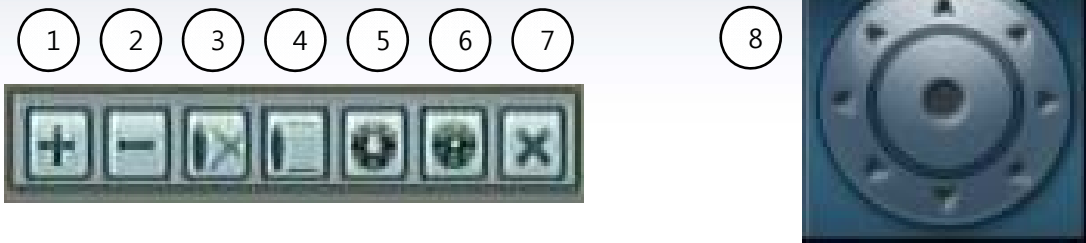

No.	Button	Function
1	TELE	Zoom in
2	WIDE	Zoom out
3	NEAR	Focus near
4	FAR	Focus far
5	OPEN	Iris open
6	CLOSE	Iris close
7	EXIT	Exit PTZ control
8	JOYSTICK	PAN/TILT control

7-2. Event Monitoring

[Event Monitoring Setup]

- (1) For event monitoring, user must have authority for Schedule and Event.
 (Access [Menu]-[System]-[User]-[Authority] and check Schedule and Event)
- (2) Access [Menu]-[Record]-[Schedule] to set Recording type for Alarm-In or Motion.
- (3) To see event in case of event:
 - Alarm : [Menu]-[Event]-[Alarm-Out]
 - Motion : [Menu]-[Event]-[Motion]-[Action]
 - Video Loss : [Menu]-[Event]-[Video Loss]
- (4) In case of event, icon for motion or alarm displays on the associated channel if checkbox of Alarm/Motion Event is checked from [MENU] - [Display] - [Display] - [OSD]:

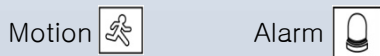

Event monitoring continues for the set dwell time for event recording and when dwell time expires, it returns to previous screen.

Set Event Refresh Time for output duration. During this duration, other events will not show.

[Menu]-[Event]-[Alarm]-[Alarm-In] - Duration/Event Refresh Time

[Menu]-[Event]-[Motion]-[Action] - Duration/Event Refresh Time

[Menu]-[Event]-[Video Loss]-[Video Loss] - Duration/Event Refresh Time

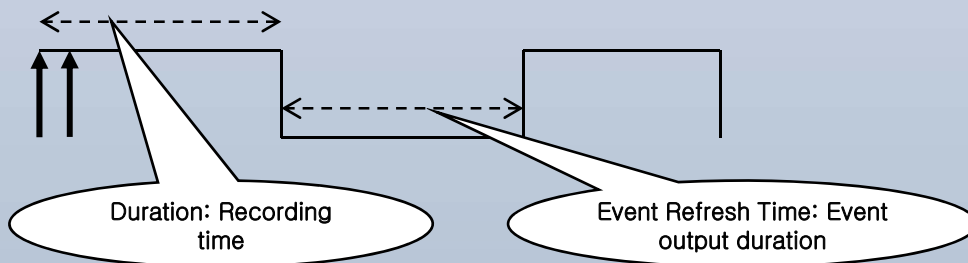

7-3. Mouse Operation

For easy operation while live monitoring, user can use mouse instead of key buttons.

In split screen mode, double clicking a certain channel screen will switch the channel into a full screen mode. Double clicking the screen again will return to previous split display mode.

Click right button of mouse while live monitoring and popup menu appears as below:

MONITORING
GOTO CHANNEL SPLITTER
PTZCONTROL FREEZE ZOOM SEQUENCE PIP AUDIO PANIC
PLAYBACK SEARCH SETUP MENU

[Live monitoring popup menu in full screen mode]

MONITORING
GOTO CHANNEL SPLITTER
PTZCONTROL FREEZE ZOOM SEQUENCE PIP AUDIO PANIC
PLAYBACK SEARCH SETUP MENU

[Live monitoring popup menu in split screen mode]

Click Freeze, Zoom, Sequence, PIP menu, and it will function the same as pressing [FRZ], [ZOOM], [SEQ], [PIP] buttons.

MONITORING
GOTO CHANNEL SPLITTER
PTZCONTROL FREEZE ZOOM SEQUENCE PIP AUDIO PANIC
PLAYBACK SEARCH SETUP MENU

CAM01
CAM02
CAM03
CAM04
CAM05
CAM06
CAM07
CAM08
CAM09
CAM10
CAM11
CAM12
CAM13
CAM14
CAM15
CAM16

Click right button of mouse in Live mode, and popup menu appears as below:

- Goto Channel : Select channel to display in full screen mode.
- 2x2 Split : Display in 4 split screen mode.
- 3x3 Split : Display in 9 split screen mode.
- 4x4 Split : Display in 16 split screen mode.

7-4. Record

[Record Setup]

(1) For Record, user must have authority for Record.

(Access [Menu]-[System]-[User]-[Authority] and check Record)

(2) For Continuous record: Access [Menu]-[Record]-[Setup]-[Channel]-[Resolution] and set record quality settings.

For event record: Access [Menu]-[Record]-[Setup]-[Event]-[Resolution] and set record quality settings.

For panic record: Access [Menu]-[Record]-[Setup]-[Panic]-[Resolution] and set record quality settings.

Overwrite on : When HDD becomes full, it starts recording images over the oldest images.

Overwrite off : When HDD becomes full, it stops recording

Factory default setting for Overwrite is OFF.

In order to enable overwriting function, access [Menu]-[Setup]-[Channel] and check checkbox for Overwrite.

Record Resolution : Record Stop, D1, 2CIF, CIF

Record quality : User can set quality among 4 steps for each camera channel. Default setting for quality is "High".

When cameras are not connected in Live mode, blue screen will display.

When cameras are not connected in Playback mode, black screen will display.

Press [PANIC] button to start recording all channels as set for Panic recording. Press the button again to return to schedule recording mode.

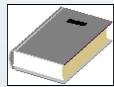

<Note>

Panic recording does not function if Overwrite function is not enabled, or HDD is full.

7-5. Audio

Connect audio input device on A IN 1 ~ 4 on the rear panel, and speaker on A OUT.

In order to record audio, check checkboxes of Record on [Menu]-[Display]-Audio.

To playback with audio, access [Menu]-[Display]-[Audio] and check Playback checkbox, and start x1 forward playback in full screen mode.

7-6. Search

While in LIVE mode, press search button or click search at MONITORING popup box, and search menu appears as below:

[1] Calendar Search

CALENDAR SEARCH		EVENT SEARCH		BOOKMARK SEARCH			
<<		2008 - 01				>>	
SUN	MON	TUE	WED	THU	FRI	SAT	
6	7	8	9	10	11	12	
13	14	15	16	17	18	19	
20	21	22	23	24	25	26	
27	28	29	30	31			
GOTO		2008-01-01	00	00	00		
<input type="button" value="PREVIEW"/>		<input type="button" value="PLAYBACK"/>		<input type="button" value="EXIT"/>			

Days with recorded data will be highlighted in white color. Click a day to see the recorded data in details by time and minute.

CALENDAR SEARCH		EVENT SEARCH		BOOKMARK SEARCH			
HOUR							
20	□□□□□□□□□□□□□□□□						
10	□□□□□□□□□□□□□□□□		□□□□□				
0	□□□□□□□□□□□□□□□□		□□□□□				
		0	10	10	10	10	
		MIN					
GOTO		2008-01-22	00	00	00	CHANNEL <input type="text" value="CH6"/>	
<input type="button" value="PREVIEW"/>		<input type="button" value="PLAYBACK"/>		<input type="button" value="EXIT"/>			

Channel : If channel ALL is selected, the dots will show if it contains recorded data or not, but if a certain channel number is selected, dots will show in 4 colors showing its recording mode.

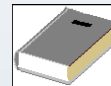

<Note>

1 dot is to 1 minute. But it doesn't always mean it contains recorded data for whole 1 minute.

Click [Playback] button when searching date and time is completed. While in playback, [LEFT], [RIGHT], [UP], [DOWN], [OK] can be used for further search.

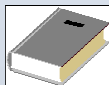

<Note>

Some camera channels may not have recorded data. Switch to 16 split screen mode to see which channels contain recorded data.

SEARCH PREVIEW	
COUNT	<input style="width: 150px;" type="text" value="9"/>
<input type="button" value="GO"/> <input type="button" value="CANCEL"/>	

When you click Preview button, it will playback recorded data for 10 seconds from set time. After 10 seconds, it returns to Calendar Search menu.

[2] Event search

CALENDAR SEARCH	EVENT SEARCH	BOOKMARK SEARCH
------------------------	---------------------	------------------------

<<	2008 - 01						>>
SUN	MON	TUE	WED	THU	FRI	SAT	
		1	2	3	4	5	
6	7	8	9	10	11	12	
13	14	15	16	17	18	19	
20	21	22	23	24	25	26	
27	28	29	30	31			

FIRST

LAST

Every time Alarm-Input port is activated, new event list will be created.

Days with recorded data will be highlighted in white color. Click a day to see the recorded data lists.

Click a day to see the event list of the day.

CALENDAR SEARCH	EVENT SEARCH	BOOKMARK SEARCH
------------------------	---------------------	------------------------

NO.	TIME	ALL TYPE	CHANNEL
1	2008-02-27 02:37:22	MOTION	
2	2008-02-27 02:37:48	ALARM	1
3	2008-02-27 02:37:49	MOTION	
4			
5			
6			
9			
8			

-Select type of events to be listed among All Type, Motion, Alarm, Loss and Panic.

-Select camera channels to be listed.

Select event and press [ENTER] button and click [Playback] to playback.

[3] Bookmark search

Admin or Manager can create bookmark list upto 24 lists each.

While in Playback mode, every time Admin or Manager presses the BOOKMARK button, new time data will be created on the list.

Bookmark : 09
2009/04/21 06:23:47

When bookmark lists are full, message appears as below:

Bookmark Over !
2008/04/21 06:23:47

CALENDAR SEARCH
EVENT SEARCH
BOOKMARK SEARCH

NO.	TIME	LOGIN	DELETE
1	2008-02-27 02:37:22	ADMIN	
2	2008-02-27 02:37:48	ADMIN	
3	2008-02-27 02:37:49	ADMIN	
4			
5			
6			
9			
8			

PREVIOUS
1 / 1
NEXT
DELETE

PREVIEW
PLAYBACK
EXIT

Select a time data and click [Playback] button to playback. Playback will continue till the end time of total recorded data on HDD.

7-7. Playback

User who has authority to playback can playback recorded data.

Set authority from [Menu]-[System]-[User]-[Authority].

While in Live mode, user can playback from Monitoring popup menu, or by clicking Playback button from Search menu

Left arrow button

Backward playback

Right arrow button

Forward playback

UP arrow button (1/32x, 1/16x, 1/8x, 1/4x, 1/2x ,1x, 2x ,4x ,8x,16x, 32x)

Increase forward playback speed.

Decrease backward playback speed.

DOWN arrow button (1/32x, 1/16x, 1/8x, 1/4x, 1/2x ,1x, 2x ,4x ,8x,16x, 32x)

Increase backward playback speed.

Decrease forward playback speed.

SEARCH / STOP

Pressing STOP button from Playback mode will switch screen to Live mode.

Pressing SEARCH button from Live mode will switch screen to Search mode.

CHANNEL BUTTON

Press camera channel button, and the associated camera screen will display in full screen mode.

MODE

Pressing [MODE] button will cycle display mode through 1, 4, 6, 8, 9, 13, 16 split screen mode. (4ch DVR – 1, 4 split screen mode, 8ch DVR – 1, 4, 6, 8 split screen mode).

In playback mode, place mouse pointer at the edge of the screen, and the control toolbar appears as below:

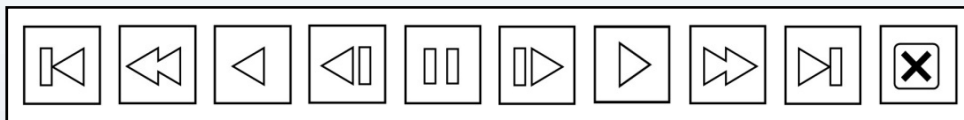

[Mouse playback control toolbar]



Goto the first image and begin forward playback



Next image



In forward playback, decrease playback speed.
In backward playback, increase playback speed



Forward playback



Backward playback



In forward playback, increase playback speed
In backward playback, decrease playback speed



Previous image



Goto the last image and begin backward playback



Freeze



Exit playback mode, and return to live mode.

7-8. Network Setup

[1] DVR Network Setup

Check Network

- 1) Click Windows START button.
- 2) Click RUN and input "cmd".
- 3) Input "ipconfig" from COMMAND AND PROMPT.
- 4) Check IP address, Subnet Mask and Gateway.
- 5) Type "Ping xxx.xxx.xxx.xxx (IP address)".

If you see "Request timed out" message, network is not connected. IP address which failed Ping Test can not be used.

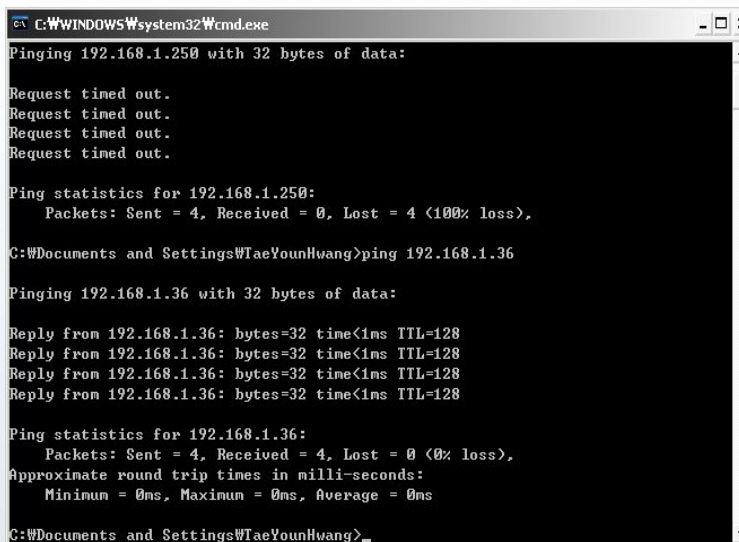

```
C:\WINDOWS\system32\cmd.exe
Pinging 192.168.1.250 with 32 bytes of data:

Request timed out.
Request timed out.
Request timed out.
Request timed out.

Ping statistics for 192.168.1.250:
    Packets: Sent = 4, Received = 0, Lost = 4 (100% loss),

C:\Documents and Settings\TaeYounHwang>ping 192.168.1.36

Pinging 192.168.1.36 with 32 bytes of data:

Reply from 192.168.1.36: bytes=32 time<1ms TTL=128
Reply from 192.168.1.36: bytes=32 time<1ms TTL=128
Reply from 192.168.1.36: bytes=32 time<1ms TTL=128
Reply from 192.168.1.36: bytes=32 time<1ms TTL=128

Ping statistics for 192.168.1.36:
    Packets: Sent = 4, Received = 4, Lost = 0 (0% loss),
    Approximate round trip times in milli-seconds:
        Minimum = 0ms, Maximum = 0ms, Average = 0ms

C:\Documents and Settings\TaeYounHwang>
```

6) If Ping test is successful, you will see message as in below image :

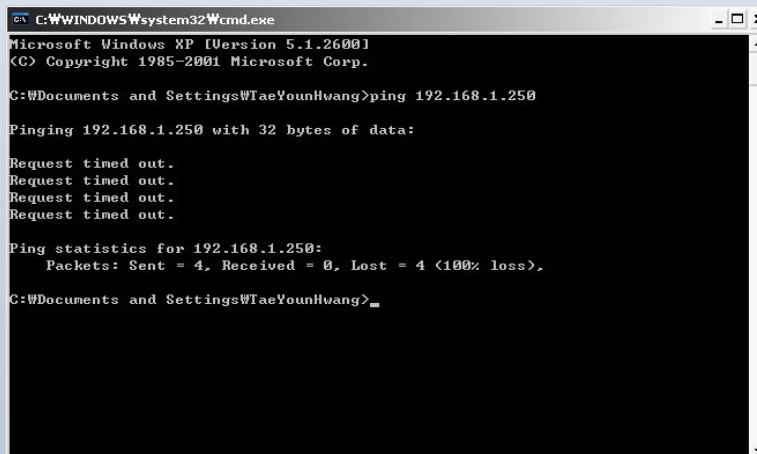

```
C:\WINDOWS\system32\cmd.exe
Microsoft Windows XP [Version 5.1.2600]
(C) Copyright 1985-2001 Microsoft Corp.

C:\Documents and Settings\TaeYounHwang>ping 192.168.1.250

Pinging 192.168.1.250 with 32 bytes of data:

Request timed out.
Request timed out.
Request timed out.
Request timed out.

Ping statistics for 192.168.1.250:
    Packets: Sent = 4, Received = 0, Lost = 4 (100% loss),

C:\Documents and Settings\TaeYounHwang>
```

[2] Static IP

Input IP address assigned from Internet Service Provider in IP SETUP.

- 1) Verify if IP address is OK with your PC before connecting DVR.

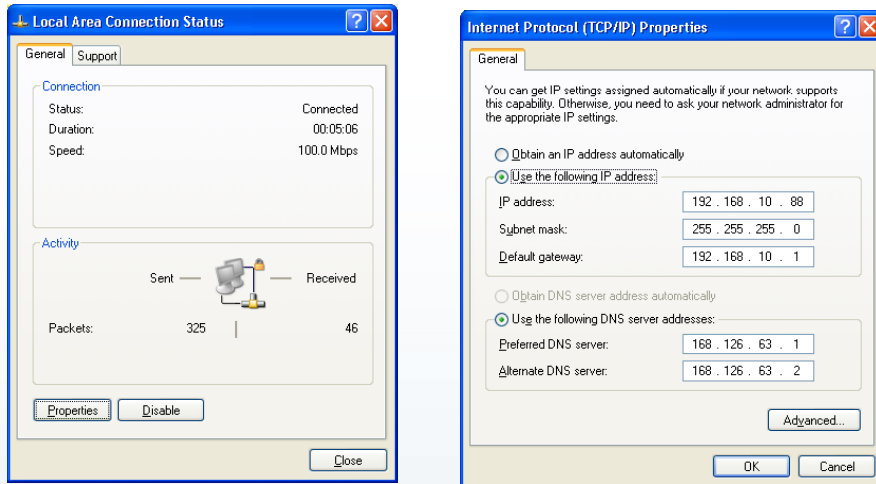

- 2) Connect static IP LAN cable to DVR after verification:

Router connection

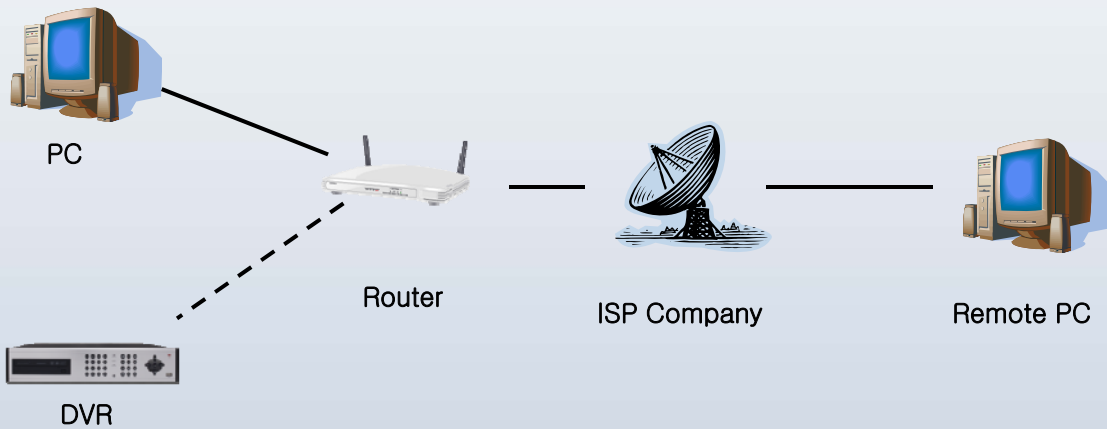

Direct connection



3) Access [Menu]-[Network]-[LAN]-[Ethernet] in DVR.

ETHERNET	DDNS	TRANSMISSION	
MAC ADDRESS	00 - 0A - A2 - 0B - 08 - 83		
IP TYPE	DYNAMIC		DHCP
IP ADDRESS	24	106	001 195
PORT	50000		
WEBSERVER	<input type="checkbox"/>	80	
GATEWAY	24	106	001 193
SUBNET	255	255	255 240
STATUS	2008/04/23 17:07:37		
SAVE		DEFAULT	CANCEL

4) Set IP TYPE to STATIC.

5) IP address popup button

In case of router connection

As in PC setup, assign internal IP address to DVR. (Ex: 192.168.0.105)
Assigned IP address should only be used for DVR internally.

In case of direct connection

As in PC setup, assign static IP address to DVR. (Ex: 211.106.1.195)
Static IP address assigned by ISP is the IP address for DVR.

6) Set IP port. (50000 recommended)

7) Input GATEWAY assigned from ISP company.

8) Input SUBNET MASK assigned from ISP company.

9) Save settings and exit menu.

10) Turn off Modem or Router provided by ISP Company, and turn on again.
(This process is to reset client's MAC from ISP Company. Wait for 30 seconds after turning on.)

11) Access DVR with IRS program.



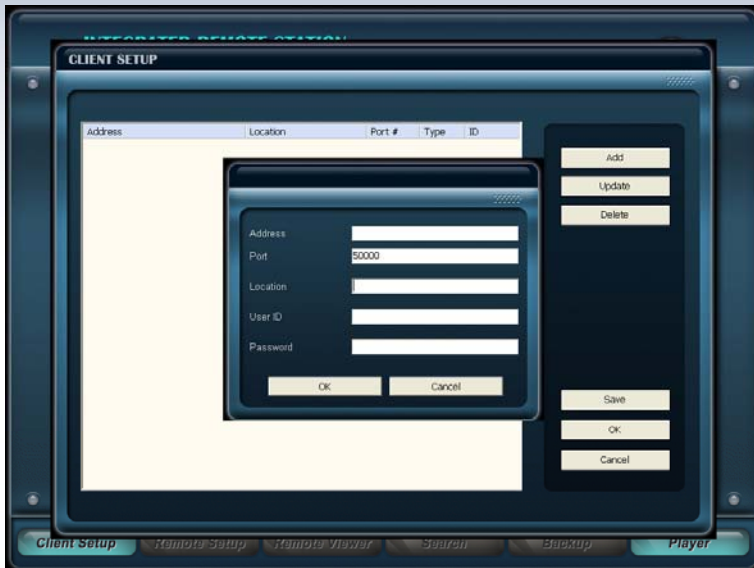

12) Click IRS Setup and click Add button.

13) Address / Port / User ID / Password Box :

In case of Router connection

Internal connection

Address : Input assigned IP address to DVR.

(Access [Menu]-[Network]-[LAN]-[Ethernet] to see assigned IP address)

Port: Input Port number. 50000 recommended.

(Input same Port number on Router and DVR in this box.)

- User ID: Input same ID as in DVR.

- Password: Input same Password as in DVR.

Remote connection

Follow all steps of Internal connection, except inputting IP address.

IP address will be assigned while Port forwarding process. Please see User Manual of Router for details.

In case of direct connection

Internal connection

Without Router, it is not able to connect DVR internally.

Remote connection

Input static IP address assigned by ISP company.

(IP address should be same as IP address set on DVR)

Port: Input Port number. 50000 recommended.

(Input same Port number on Router and DVR in this box)

- User ID: Input same ID as in DVR.

- Password: Input same Password as in DVR.

14) Click [OK] to save, and click [OK] button on the IRS SETUP window.

15) Login window pops up. Input same ID and Password as in DVR to login.

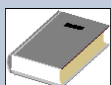

<Note>

* If access to IRS fails, check 1), 5), 6), 7), 8) and 10) again.

[3] Dynamic IP

Select DYNAMIC IP from DVR's TCP/IP SETUP and IP address will be assigned from ISP's DHCP server.

1) Verify if IP address is OK with your PC before connecting DVR.

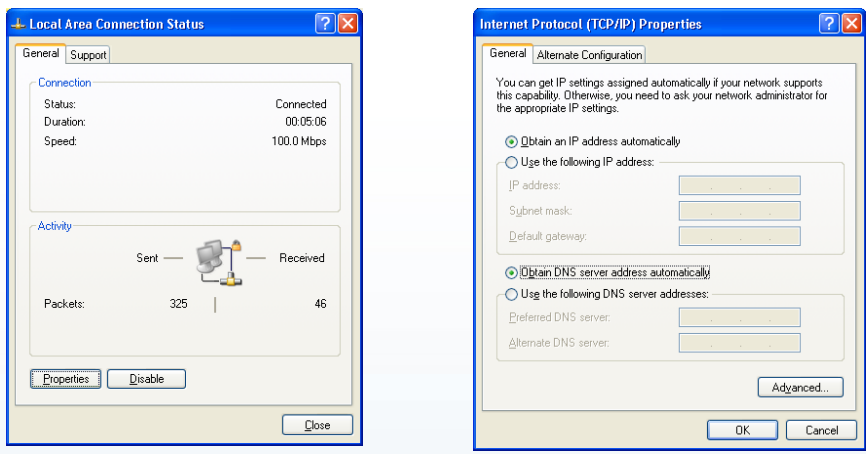

2) Connect dynamic IP LAN cable to DVR after verification.

Router connection

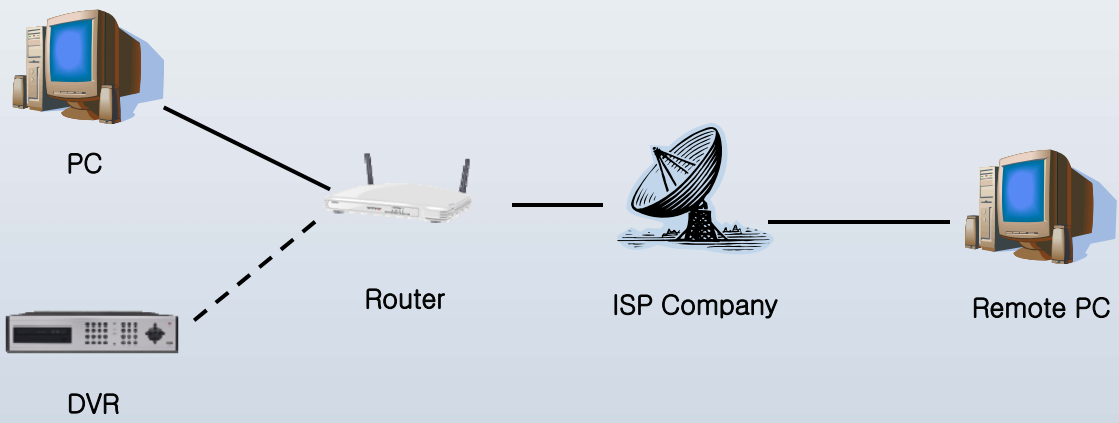

Direct connection



- 3) Turn off Modem provided by ISP company, and turn on again.
(This process is to reset client's MAC from ISP company. Wait for 30 seconds after turning on.)
- 4) If modem works good, turn DVR off and turn on again.
- 5) Access [Menu]-[Network]-[LAN]-[Ethernet] in DVR.

ETHERNET	DDNS	TRANSMISSION	
MAC ADDRESS	00 - 0A - A2 - 0B - 08 - 83		
IP TYPE	DYNAMIC	DHCP	
IP ADDRESS	24	106	001 195
PORT	50000		
WEBSERVER	<input type="checkbox"/>	80	
GATEWAY	24	106	001 193
SUBNET	255	255	255 240
STATUS	2008/04/23 17:07:37		
SAVE		DEFAULT	CANCEL

- 6) Set IP TYPE to Dynamic and click DHCP button, and IP address and Gateway will be read automatically.
- 7) Set IP Port. (50000 recommended)
- 8) Save settings and exit menu.
- 9) Access DVR with IRS program.





11) Click IRS Setup and click Add button.

12) Address / Port / User ID / Password Box :

In case of Router connection

Internal connection

Address : Input assigned IP address to DVR.

(Access [Menu]–[Network]–[LAN]–[Ethernet] to see assigned IP address)

Port: Input Port number. 50000 recommended.

(Input same Port number on Router and DVR in this box.)

– User ID: Input same ID as in DVR.

– Password: Input same Password as in DVR.

Remote connection

Follow all steps of Internal connection, except inputting IP address.

IP address will be assigned while Port forwarding process. Please see User Manual of Router for details.

In case of direct connection

Internal connection

Without Router, it is not able to connect DVR internally.

Remote connection

Input dynamic IP address assigned by ISP company.

(IP address should be same as IP address set on DVR)

Port: Input Port number. 50000 recommended.

(Input same Port number on Router and DVR in this box)

– User ID: Input same ID as in DVR.

– Password: Input same Password as in DVR.

13) Click [OK] to save, and click [OK] button on the IRS SETUP window.

14) Login window pops up. Input same ID and Password as in DVR to login.

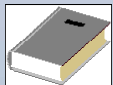

<Note>

* If access to IRS fails, check 1), 3) and 4) again.

[4] e-mail setup

SETTING	EMAIL	EVENT
RETRY COUNT	<input type="text" value="10"/>	
SEND INTERVAL	<input type="text" value="10"/>	MINUTE
	<input type="text" value="10"/>	EVENT COUNT
SEND CONDITON		
ALARM	<input type="checkbox"/>	
MOTION	<input type="checkbox"/>	
VIDEO LOSS	<input type="checkbox"/>	
PANIC	<input type="checkbox"/>	
[SAVE] [DEFAULT] [CANCEL]		

SETTING	EMAIL	EVENT
SEND E-MAIL ON/OFF	<input type="text" value="ON"/>	
SEND SERVER IP	<input type="text" value="210"/> <input type="text" value="126"/> <input type="text" value="014"/> <input type="text" value="160"/>	
SEND PORT	<input type="text" value="80"/>	
AUTHENTICATION	<input type="checkbox"/>	
SEND SERVER ID	<input type="text" value="SDVR"/>	
SEND SERVER PW	<input type="text" value="****"/>	
SENDER	<input type="text" value="hotmail.com"/>	
RECIPIENT	<input type="text" value="sdvr@hotmailcom"/>	
[SAVE] [DEFAULT] [CANCEL]		

1) Send Server IP address setup

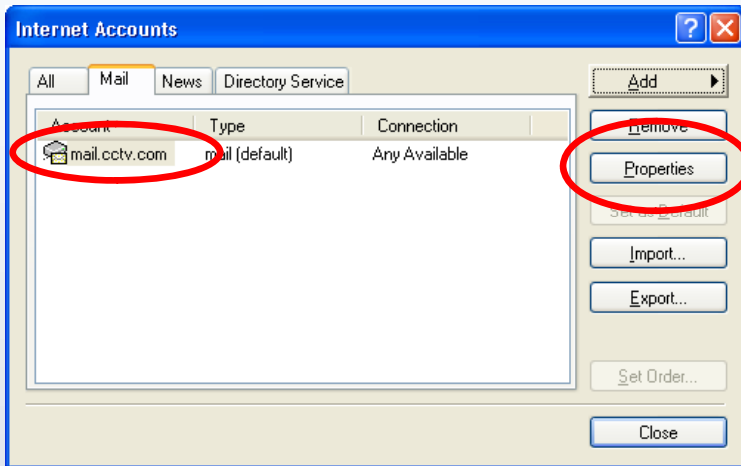

In Send Server IP box, input SMTP server IP address received from System Manager. In case users don't know SMTP server IP address, ask to server administrator.

Check send server IP for Outlook Express :

Open **Outlook Express**, and click **TOOLS(T) – ACCOUNT(A)**.

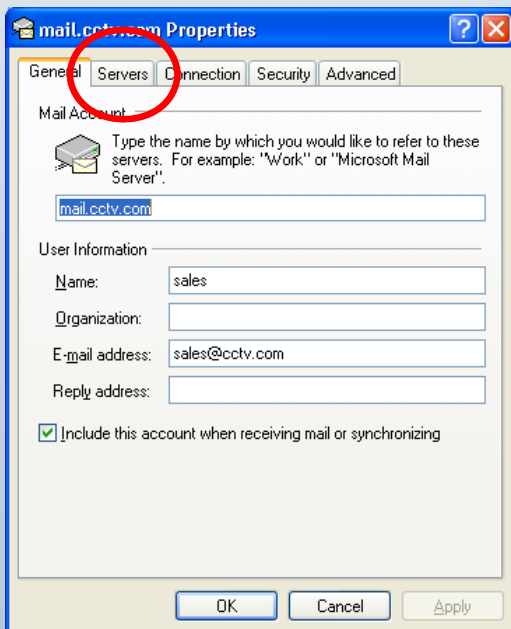

Click **PROPERTY(P)**, and property window pops up as left image.

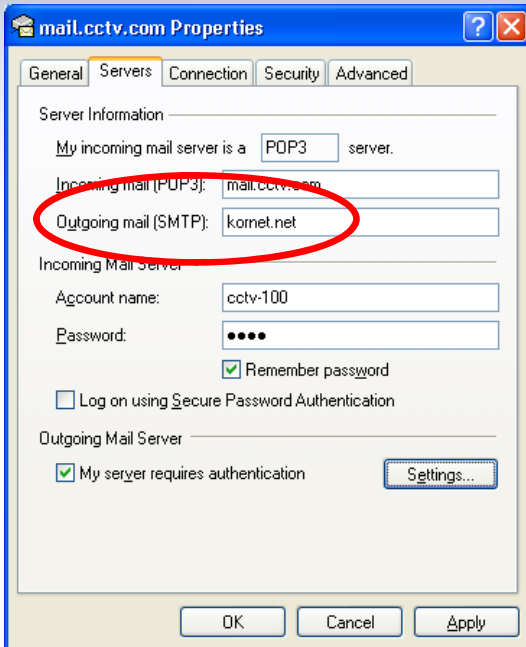

Click SERVERS tap, and you can check SMTP address.

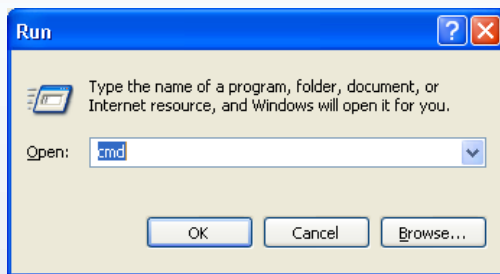

Click Windows START button, and click RUN and input "cmd".

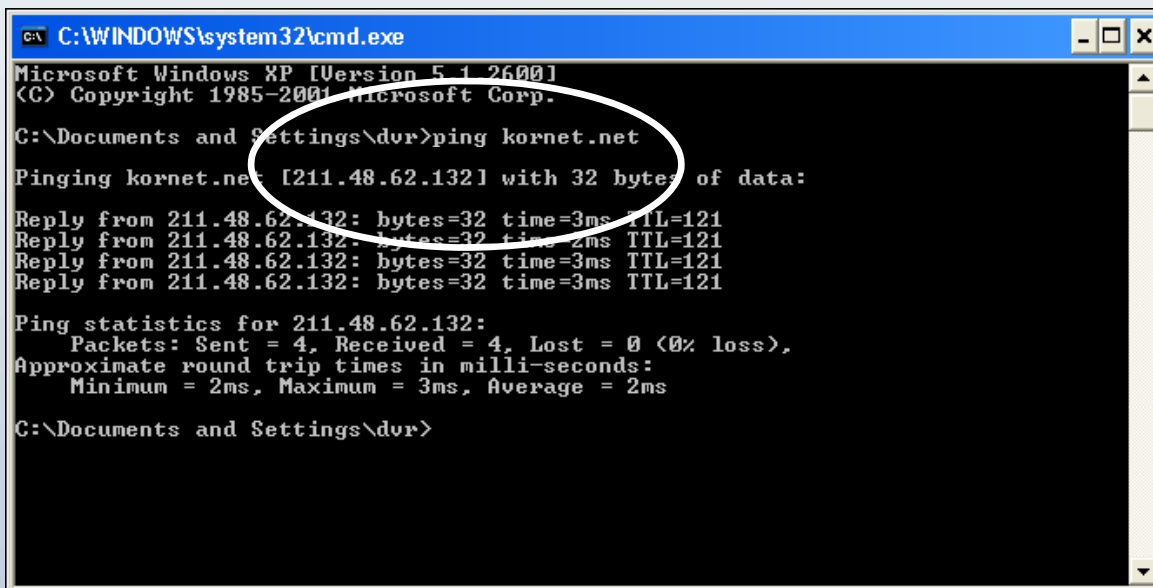

Input "ping xxxxx.xxx(SMTP address)" and you can check IP address. Set this IP address in Send Server IP popup button.

2) Send Port Setup

Input 25 for mail port number in DVR. (In case of no activation, ask to SMTP server administrator.)

3) Send Server ID / Send Server PW Setup

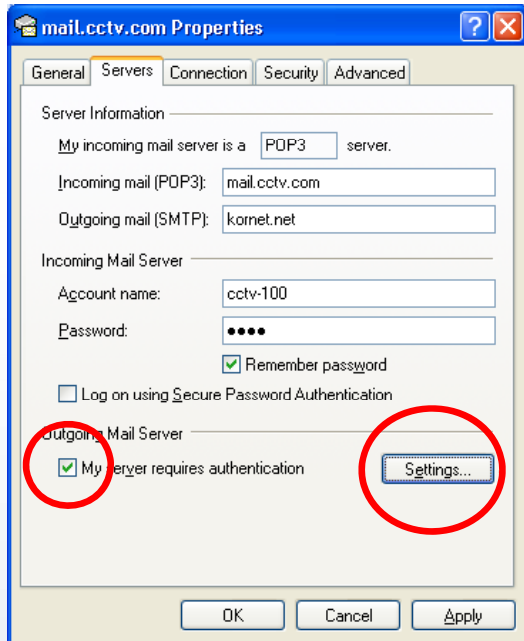

Input ACCOUNT NAME(C) to Send Server ID on your DVR.

Input PASSWORD(P) to Send Server PW on your DVR.

In case users don't know Send server ID/PW, ask to SMTP server administrator.

4) Recipient Setup

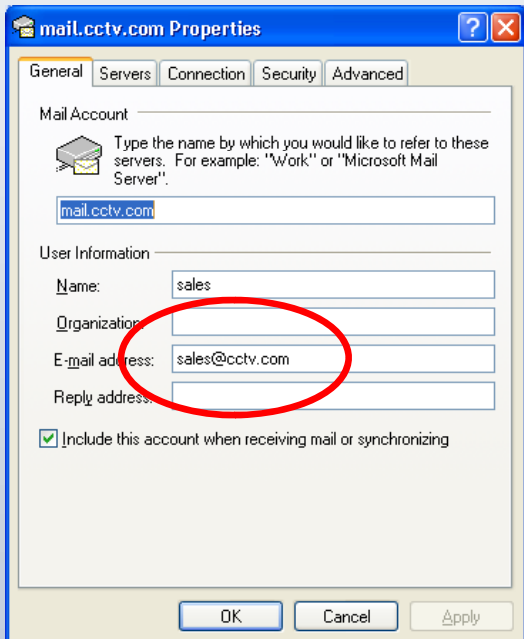

Input E-MAIL ADDRESS(M) to Recipient on your DVR.

Received e-mail will show details as below:

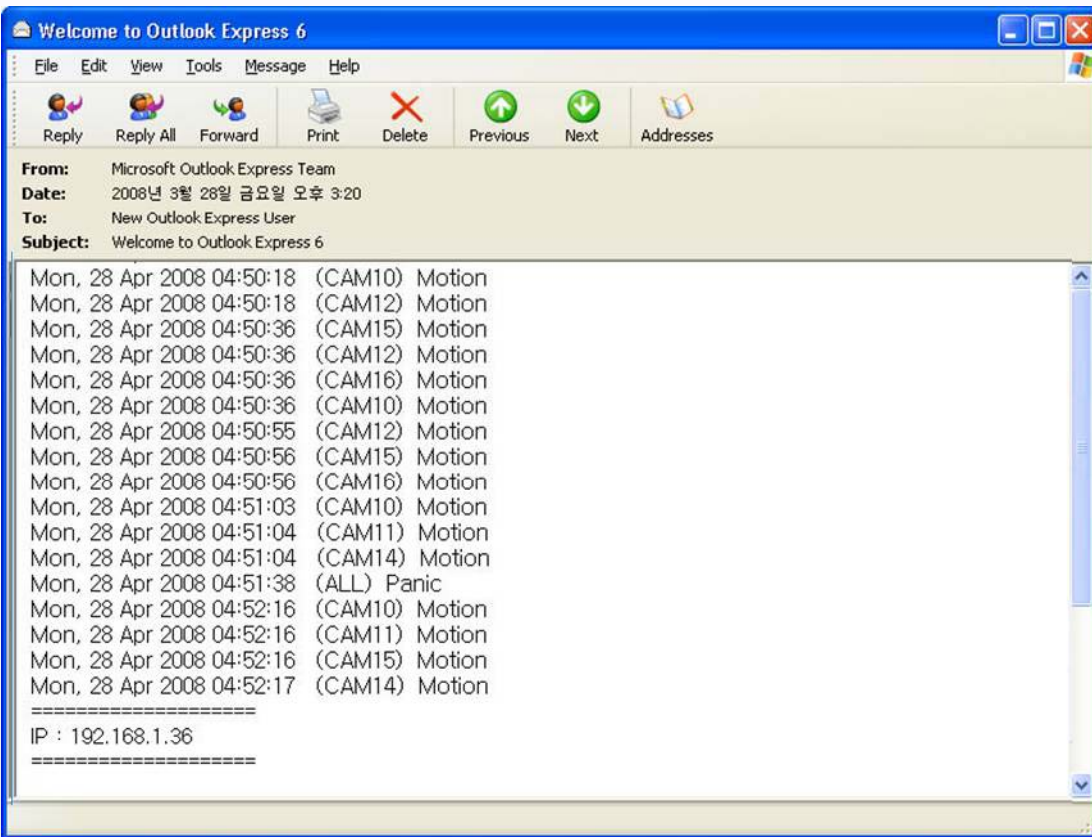

CHAPTER 8. Integrated Remote Station

8-1. IRS Setup

1) See PC specification below for IRS operation.

Contents	Min. Spec.	Recommended Spec.
CPU	Intel Pentium 4 3.0GHZ	Intel Pentium 4 Core2Duo 1.8 or higher
Main memory	512MB	1GB or higher
Video memory	128MB	512MB or higher
HDD	80GB	120GB or higher
Network	Cable/DSL	Fast Ethernet
OS	Window XP, Window Vista	
Monitor	1024 X 768 (with 24 bit color) or higher	
Others	Direct X 9.0 or later version	

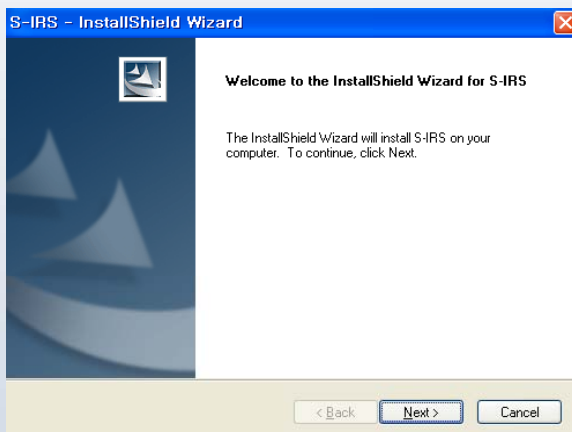

2) Insert software CD and run install file. Click [Next] button.

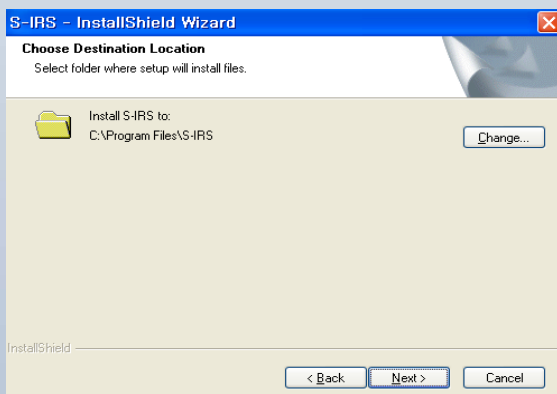

3) S-IRS program will be installed in C:\WProgram Files\WS-IRS folder. If you want to change directory, click [Change] button. Click [Next] button.

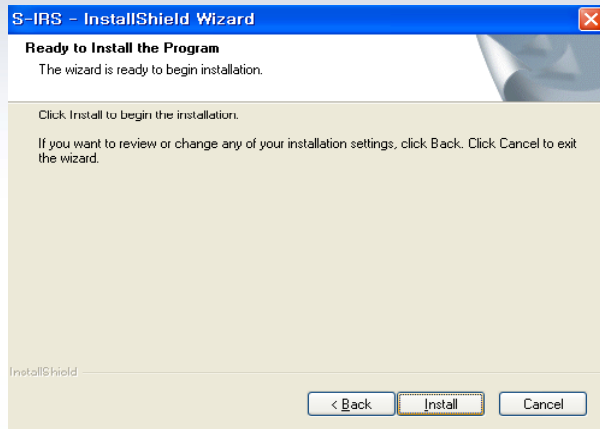

4) If you want to review or change any of installation settings, click [BACK], or if you want to proceed, click [NEXT].

5) When you click [NEXT] button, you will see installation process, and when installation is done, S-IRS icon will be created on windows background.

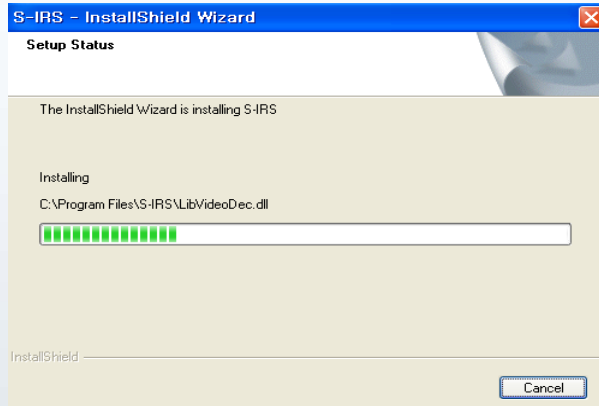

8-2. IRS Operation

[1] IRS (Integrated Remote Station) Display



- **CLIENT SETUP:** Setup for network connection.
- **REMOTE SETUP:** Change DVR setup remotely over network.
- **REMOTE VIEWER:** View live display of DVR.
- **SEARCH:** Search recorded data on DVR HDD.
- **BACKUP:** Backup recorded data in DVR to PC.
- **PLAYER:** Playback backup file on PC.(sm4 file format)

[2] Client Setup

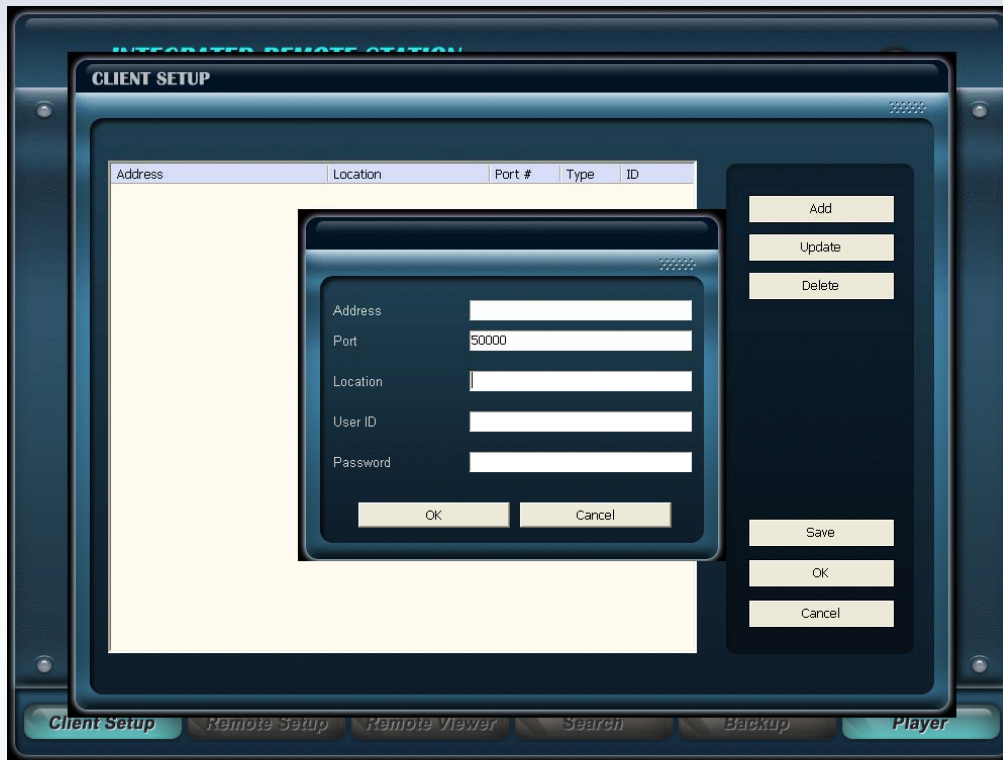

- ADDRESS : Input same IP address set on DVR.
- PORT : Input same Port number set on DVR.
- USER ID: Input same ID as in DVR.
- Password: Input same Password as in DVR.

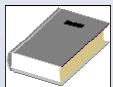

<Note>

- * IP address and Port number : [Menu]-[Network]-[LAN]-[Ethernet].
- * User ID and Password : [Menu]-[System]-[User].
- * Select User ID among Admin, Manager, User 1 ~8.
- * Admin has authority to access all menus.
- * Manager has authority to access IRS Setup, Viewer, Search, Backup and Player.
- * User 1 ~ 8 has authority to access IRS Setup, Viewer, Player.

- ADD : Register IP Setup Value of IP SETUP box to SITE SETUP box.
- UPDATE : Edit IP Setup Value registered on SITE SETUP box.
- DELETE : Delete IP Setup Value registered on SITE SETUP box.
- SAVE : Save IP Setup Value registered on SITE SETUP box.
- OK : Click OK to popup login window. Input password to Login.
- CANCEL : Return to main menu.

[3] Remote Setup

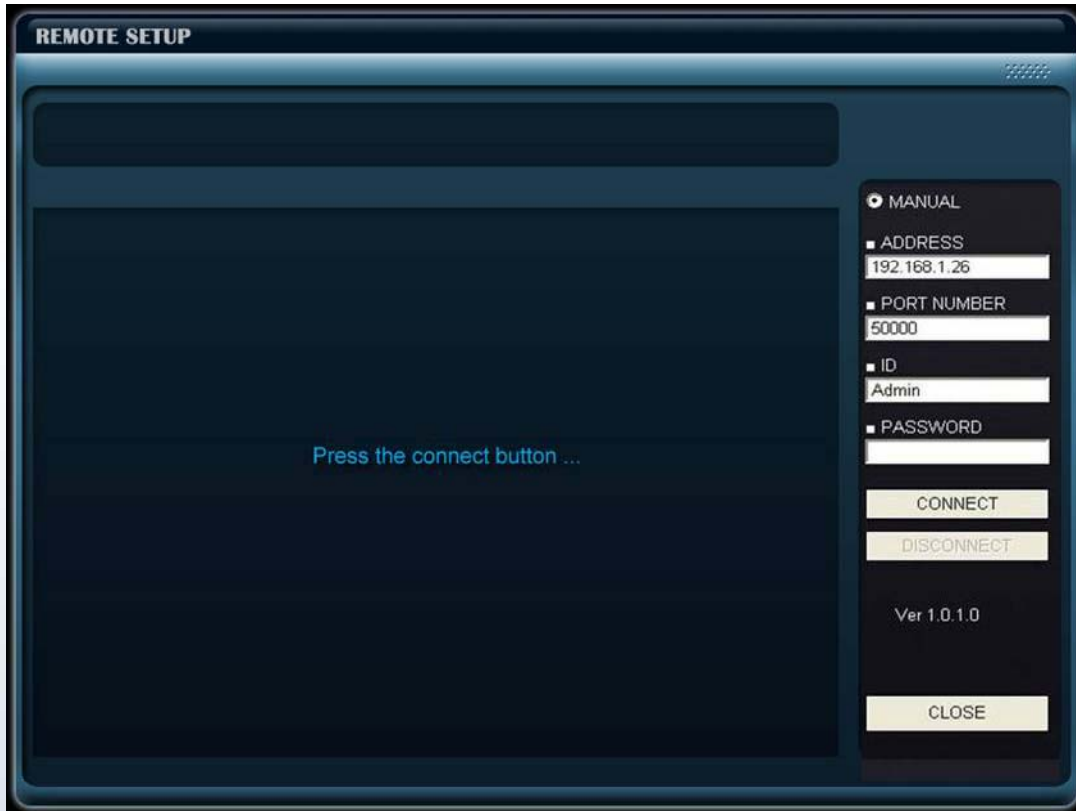

- MANUAL : Select to input IP address and Port number manually.
- ADDRESS : Input same IP address set on DVR.
- PORT NUMBER : Input same Port number set on DVR.
- ID : Input same ID as in DVR.
- PASSWORD : Input same Password as in DVR.
- CONNECT : Connect to access DVR's SETUP MENU.
- CLOSE : Exit DVR Setup and return to main page.

Each menu is identical to the setup menus of the DVR. Refer to Chapter 5. DVR Setup for more details.

8-3. Remote Viewer

[1] Remote Viewer



- 1) **DVR connection setup**: Input IP address, Port number, ID, Password for network connection to DVR.
- 2) **System Information**: Displays DVR connection and progress status.
- 3) **PTZ Control**: Control PTZ cameras connected to DVR.
(PTZ setting in DVR should be completed before use.)
- 4) **Connect** : Connect to DVR via network to view live image.
Disconnect : Disconnect network connection.
- 5) **Setup** : Set quality and frame rate for each camera channel.
- 6) **2 Way Audio** : Enable 2 way audio system between DVR and Viewer.
Note that both Refresh Rate and Quality in 5) **Setup** should be set to 'Low' while operating 2 Way Audio, otherwise audio quality may suffer.
- 7) **Channel selection** : Select a channel or a group of channels to display in full screen or in 4/9/16 split screen mode.
- 8) **Screen division** : Select layout of split screen.
- 9) **Audio channel** : Select an audio channel to turn on. Note that the 'Enable Audio' checkbox in 5) **Setup** should be checked as enabled and both Refresh Rate and Quality should be set to 'Low', otherwise audio quality may suffer.

8-4. Search

[1] Search



- 1) DVR connection setup : Input IP address, Port number, ID, Password for network connection.
- 2) System information : Displays connection status and system operation information.
- 3) Start / End : Displays start time and end time of total recorded data.
- 4) Connect : Connect to DVR via network.
Disconnect : Disconnect network.
- 5) Event : Click to pop up window for search by date, event and bookmark.
- 6) Edit : Edit freeze image in full screen mode.
- 7) AVI Save : Save a full screen mode channel in AVI file format.
- 8) Channel selection : Displays selected channel in full screen mode.
- 9) Screen division : Select screen split layout among 1,4,9,16 split mode.
- 10) Control bar : Playback control toolbar (See next page for details)

<Buttons from left to right>

Goto the first image
 Fast backward playback
 Backward playback
 Freeze
 Playback
 Fast playback
 Goto the last image

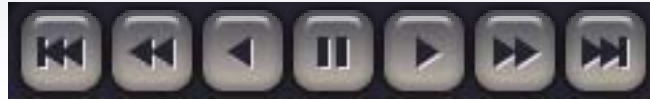

- 11) Audio channel : Select audio channel to turn on.
- 12) Time : Current playback time.
- 13) Exit : Exit program

[2] Percent / Date search

Click EVENT button from main Search page.



- 1) Start / End : Displays start time and end time of total recorded data on DVR.
- 2) Date / Time : Search by input date and time.
- 3) Search bar : Search by percentage of recorded data on HDD.
- 4) OK : Request DVR to search data on set time.
 From main Search page, click PLAY button to begin playback on set time.
- 5) Cancel : Close search window.

[3] Event list search

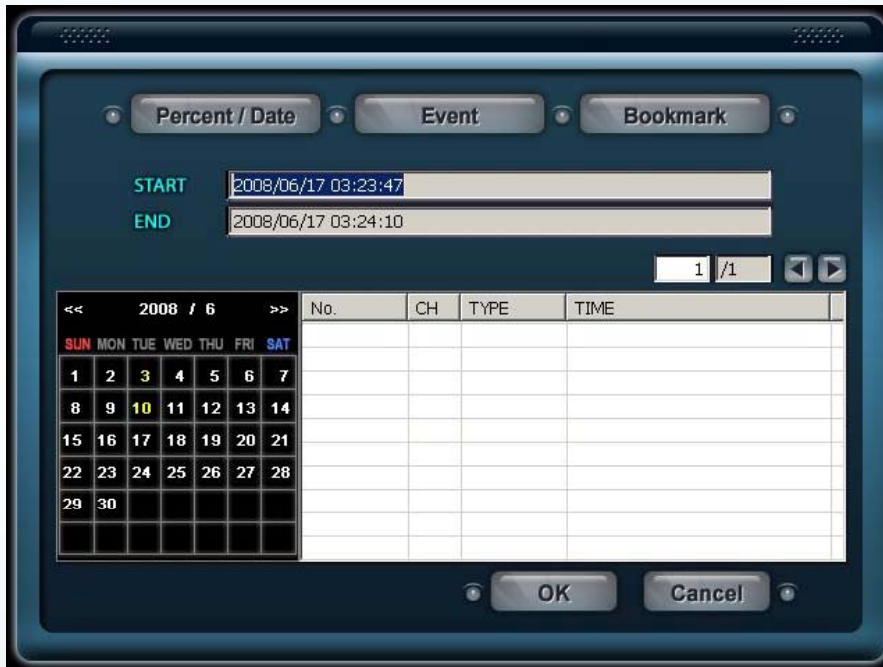

Click date on calendar, and Event List of the day will be displayed. Select event and click OK to playback, or just double click the event.

Left / Right button : Displays Previous / Next 100 lists.

[4] Bookmark list search

Every time the user, logged in as Admin or Manager, pressed the [BOOKMARK] button, new time data is created on the list.

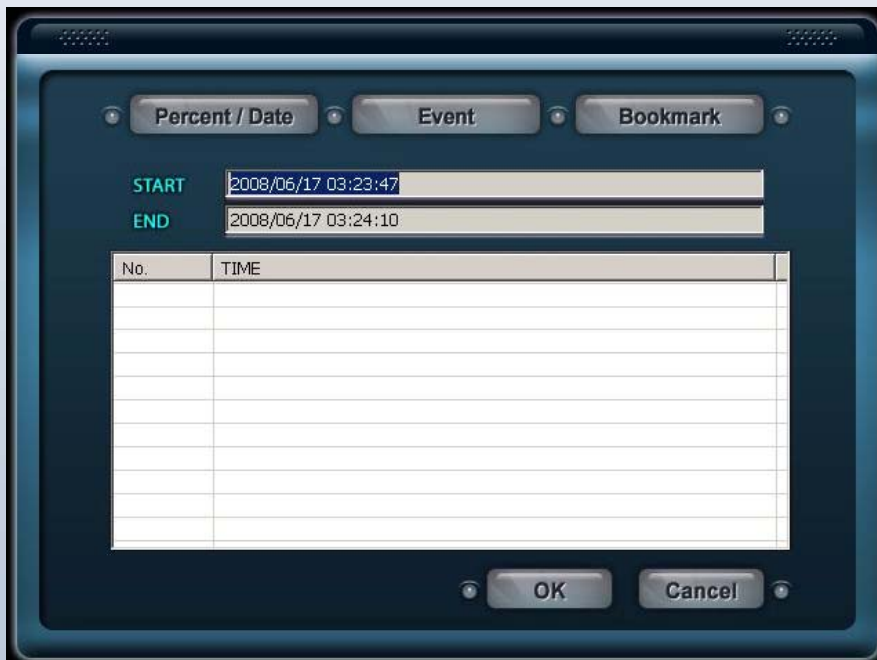

Select time data and click OK to playback, or just double click the time data.

8-5. Backup

1) To run BACKUP, input IP Address and Port, and click Connect Test button.

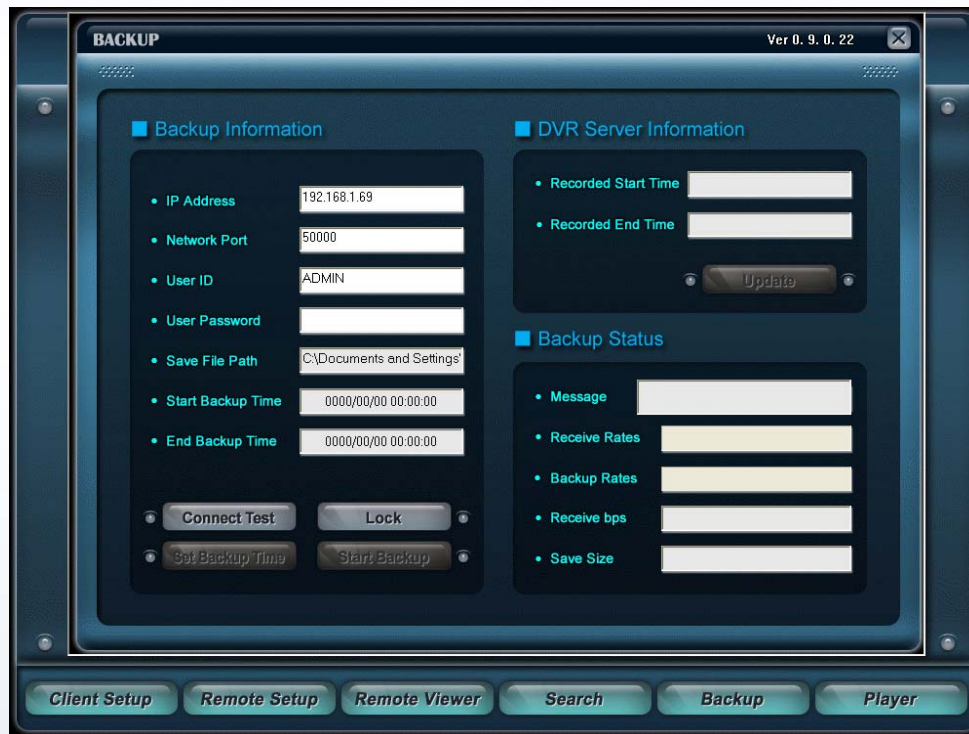

2) Click Connect Test button, and when network connection is successful, "Success Connect Test!" message will appear in the message box.



3) Click Lock button, and receives information of recorded start time / end time from DVR. It will automatically update information every 10 seconds, or click Update button for immediate update.

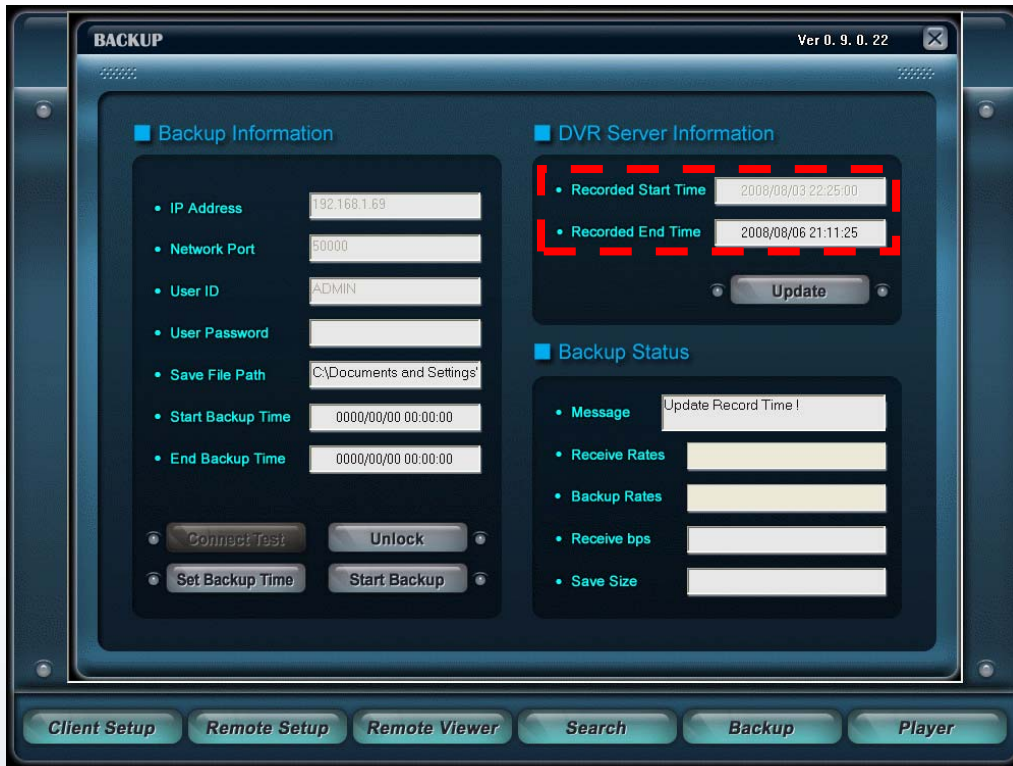

4) Click Set Backup Time button and set Start Time, End Time, Save File Path, File Size, and click Apply button.

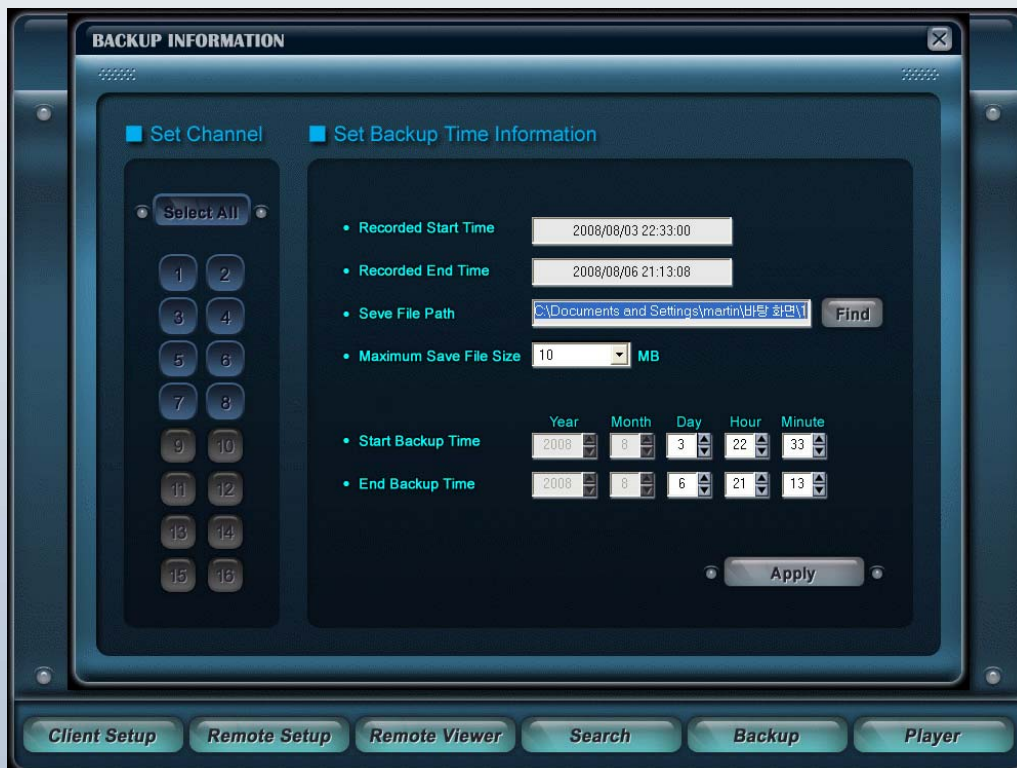

- Recorded Start Time : Start time of recorded data on HDD at the time of clicking LOCK button.
- Recorded End Time : End time of recorded data on HDD at the time of clicking LOCK button.
- Save File Path : Set path to save backup file on PC.
- Maximum Save File Size : Split file size into 10MB,50MB,100MB,150MB, 200MB ~ 700MB.
- Start Backup Time : Set start time of data to backup.
- End Backup Time : Set end time of data to backup.
- Set Channel : Click SELECT ALL button to backup all channels, or select each channel to backup by clicking the channel number (Grey: Off Blue: On)

5) After setting Set Backup Time, click Start Backup button. You will see backup file created on the path you set.

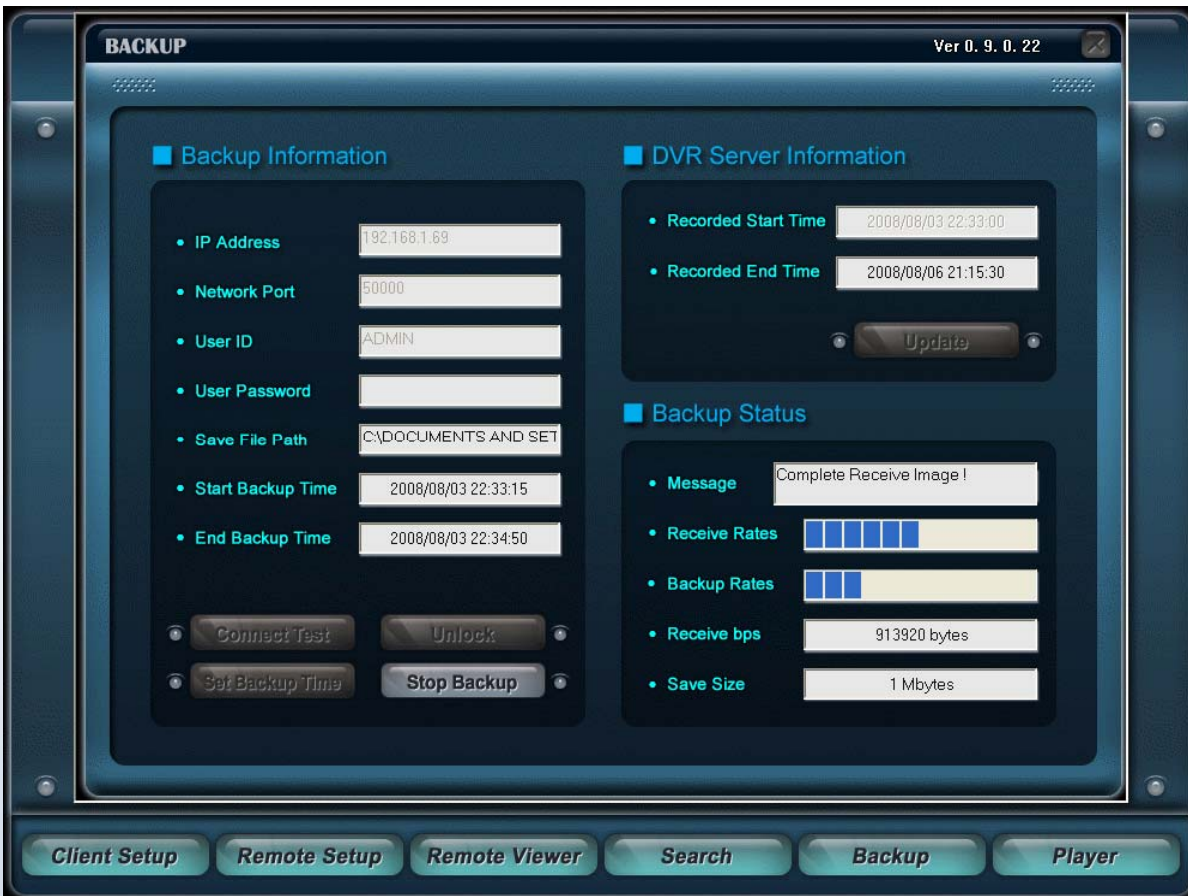

- Receive Rates : Displays progress of sending a packet.
- Receive bps : Displays transmit data size per second.
- Backup Rates : Displays Save Size rate.
- Save Size : Displays file size of backup data.

8-6. Player

[1] Player

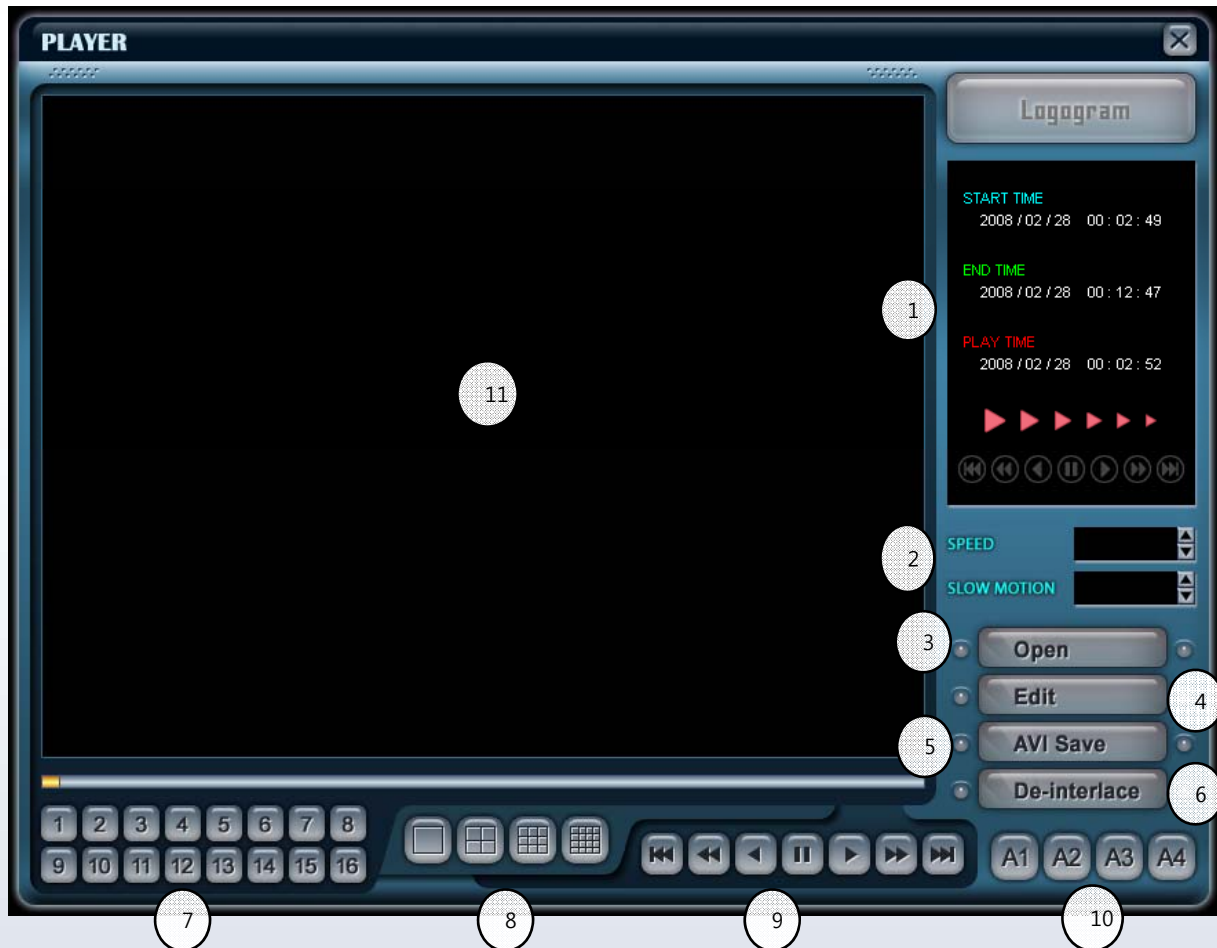

- 1) TIME : Displays start time, end time, current playback time.
- 2) SPEED / SLOW MOTION : Control playback speed.
 SPEED: Set fast playback speed : 2x, 4x, 8x, 16x 32x
 SLOWMOTION: Set slow playback speed : 1x, 1/2x, 1/4x, 1/8x, 1/16x, 1/32x
- 3) Open : Playback backup file on PC. (SM4 file format)
- 4) Edit : Edit freeze image in full screen mode.
- 5) AVI Save : Save a full screen mode channel in AVI file format.
- 6) De-interlace : De-interlace D1 size image.
- 7) Slide Bar: Search data with slide bar.
- 8) Channel selection : Displays selected channel in full screen mode.
- 9) Screen division : Select screen split layout among 1, 4, 9, 16 split.
- 10) Control : Control playback toolbar.
- 11) Audio channel : Select audio channel to turn on.
- 12) Display : Displays playback image of backup data.
- 13) Exit : Exit program.

[2] Player – Edit Panel



< IMAGE EDIT >

1) CONTRAST: Set contrast in full screen mode.



: Make bright part brighter and dark part darker.



: To reduce light and shade, lower contrast.

2) BRIGHT: Set brightness in full screen mode.



: Make image brighter.



: Make image darker.

3) SHARP: Set sharpness in full screen mode.



: Make sharp-edge effect.

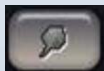

: Make image soft.

4) IMAGE SAVE: Save full screen freeze image to file.



: Save image in JPEG file format.

Image will be saved in the folder where playback program is installed

5) IMAGE PRINT: Print full screen freeze image.



: Print image.

[3] Player – AVI Save Panel



< AVI SAVE >

7) AVI Save Option: Set frame rate, size of file to be saved in AVI format.

CHANNEL : Select channel of image to save.
FRAMERATE : Select FPS of image to save.
SIZE : Select file size of the image to save.

8) Start : Start saving data in AVI file format.

9) Stop : Stop saving data in AVI file format.

When AVI SAVE is completed, "C:\WEB_BACKUP" folder pops up.

Appendix A. Frequently Asked Questions

Q. Turned power switch to ON, but DVR doesn't turn on.

A. Check if power cord is well connected to DC 12V power jack.

Q. After turning on DVR, Power LED on front panel lights, but no video output on monitor.

A. Check if monitor is turned on.

Check if brightness of monitor is too dark.

Check if video output cable on DVR is well connected to video input cable on monitor.

Q. I hear no audio sound.

A. First access [MENU]-[Device]-[Buzzer], and check if buzzer menus are "On".

And then, access [MENU]-[Display]-[Audio],

and check if "Playback" is checked for audio in playback mode,

and check if "Audio Out" is checked for audio in live mode.

Q. Remote control doesn't work.

A. Check if remote control type is "Universal". If remote control is universal, access [MENU]-[Display]-[Remote Control]-[REMOTE CONTROL] and check remote control type : U Type1 ~ U Type6. Press associated number button on upper part of remote control.

Check batteries in remote control.

Q. It doesn't record on HDD.

A. Check if overwrite is enabled from [MENU]-[Record]-[Setup]-[Channel].

Check if someone turned DVR off and replaced HDD while schedule recording.

Q. It doesn't record on date set to holidays.

A. Check if current time is set correctly from [MENU]-[System]-[Data/Time]-Data/Time,

and also check if holiday date is correctly set from [MENU]-[Record]-[Schedule].

Appendix B. Factory Default Value

When you press Default All button on [Menu]-[System]-[Information] all values will be defaulted as ex-factory setting values. See below for detailed factory default values.

< System Menu >

MENU	SUBMENU	MENU TITLE	FACTORY DEFAULT VALUE
information	information	language	English
Date/Time	Date/Time	Time format	00
		Time Zone	(GMT) Greenwich Mean Time : London, Dubi
		Use DST	Not checked
	Holiday	Select day of week	Sunday
	Time Sync	Automatic Sync	Off
		Time Server	211,062,253,088
		Retry Count	03
		Interval	0.5
		Last Sync- Time	----/--/-- --:--:--
Storage	Information		
User	User	User	Admin
		Auto Login	Not checked
		Auto Logout	Off
Logout			

MENU	SUBMENU	MENU TITLE	FACTORY DEFAULT VALUE	
LAN	Ethernet	MAC Address	00-0A-A2-08-08-68	
		IP TYPE	Dynamic	
		Port	50000	
	DDNS	DDNS On/Off	Off	
		DDNS Server	Static IP	211.062.253.088
				0000
			DVR ID	SDVR 16CH
		Update Interval	10	
		Last Update	----/--/-- --:--:--	
	Transmission	CH1 ~ CH16	Checked	
	Notification	Email	Send M-mail On/Off	Off
Retry Count			10	
Sender Server IP			210.126.014.160	
Send Port			26	
Send Server ID			SDVT	
Send Server PW			****	
Sender			hotmail.com	
Recipient			sdvr@hotmail.com	
Event		Active	Not checked	
		IP Address	192.168.001.072	
		Port	09988	
		Send Condition	Minute	
		Send Interval	10	
		Retry Count	6	

MENU	SUBMENU	MENU TITLE	FACTORY DEFAULT VALUE	
Camera	Camera	Copy Settings	CH1: Checked, CH2~CH16: Not checked	
		Title	CAM01 ~ CAM16	
		Covert	Off	
		Adjustment	Brightness →	-10
			Contrast →	-5
			Saturation →	+16
			Hue →	+16
			Position ->	+7
	PTZ	Copy Settings	CH1: Checked, CH2~CH16: Not checked	
		Protocol	PELCO-D	
		PTZ ID	1 ~ 16	
		Speed	7	
		Baud rate	9600	
	Audio	Audio	Record	1, 2, 3, 4CH All Checked
Playback			1, 2, 3, 4CH All Checked	
Audio Out			1, 2, 3, 4CH All Checked	
Display	OSD	Date/Time	Checked	
		Percent Bar	Checked	
		Camera Title	Checked	
		Resolution/Quality	Checked	
		Alarm/Motion Event	Checked	
		Boot Logo	Not checked	
		Transparency	-12	

MENU	SUBMENU	MENU TITLE	FACTORY DEFAULT VALUE
		OSD Margin	Left → +15
		Right → + 15	
		Top → +4	
		Bottom → +10	
	Main	Sequence Mode	Full 1 Ch
		Sequence Interval	2
		Event Popup	Off
		Popup Event Type	Alarm
		Popup Dwell	2
	Spot	Spot Monitor	On
		Spot Event Type	All
		Spot Dwell	2
		Spot Channel	CH1 ~ CH16 All Checked
	VGA	VGA Resolution	800 x 600 / 75 Hz
RS232	RS232	Baud rate	115200
		Data bits	8
		Stop bits	1
		Parity	None
	REMOTE CONTROL	Remote Control Type	SINGLE
Buzzer	Buzzer	Buzzer	On
		Video Loss	On
		Alarm-In	On
		Motion Detect	On

MENU	SUBMENU	MENU TITLE	FACTORY DEFAULT VALUE	
Setup	Channel	Copy Settings	CH1: Checked, CH2~CH16: Not checked	
		Resolution	CIF	
		Quality	High	
		FRS	12	
		Overwrite	Not checked	
	Event	Copy Settings	CH1: Checked, CH2~CH16: Not checked	
		Resolution	CIF	
		Quality	High	
		FRS	12	
		Panic	Copy Settings	CH1: Checked, CH2~CH16: Not checked
	Resolution		CIF	
	Quality		High	
	FRS		12	
	Schedule	Schedule	Channel	CH1
			Record Type	Off
CH1 ~ CH16			Time Event	
Pre-Event	Pre-Event	CH1 ~ CH16	All Not checked	
		Quality (CIF)	High	
		FPS	12	
Backup	CDRW Backup	Media	--- MB	
		Backup Size	0 MB	
	USB Backup	Media	--- MB	
		Backup Size	0 MB	

MENU	SUBMENU	MENU TITLE	FACTORY DEFAULT VALUE
Alarm	Alarm-In	Copy Settings	CH1: Checked, CH2~CH16: Not checked
		Type	N.O
		Beep	Off
		Alarm-Out 1	Not checked
		Alarm-Out 2	Not checked
		Duration	1
		Event Refresh Time	1
	Alarm-Out	Day	Off
		Start Hour	00, 00
		End Hour	23, 59
		Mode	Event
		Alarm-Out 1	Not checked
Alarm-Out 2	Not checked		
Motion	Setup	Copy Settings	CH1: Checked, CH2~CH16: Not checked
		Type	On
		Beep	Off
		Sensitivity	Normal
		Mask Zone	74 deactivated cells
		Zone View	Off
		Detect Cell Number	10

MENU	SUBMENU	MENU TITLE	FACTORY DEFAULT VALUE
	Action	Copy Settings	CH1: Checked, CH2~CH16: Not checked
		Alarm-Out 1	Not checked
		Alarm-Out 2	Not checked
		Duration	10
		Event Refresh Time	1
Video Loss	Video Loss	Copy Settings	CH1: Checked, CH2~CH16: Not checked
		Beep	On
		Alarm-Out 1	Not checked
		Alarm-Out 2	Not checked
		Duration	1
		Event Refresh Time	1

Appendix C. Specification & Dimension

- Real-Time Live Display in all Channel
- Quadplex (Live, Playback, Recording, Network)
- Multi Language
- Remote monitoring and Download through Network
- Convenient Search Function with Jog/Shuttle
- Firmware Upgrade via USB Port
- Easy PTZ Camera Control with Mouse
- Password Protection
- Remote Control
- User-Friendly Mouse control

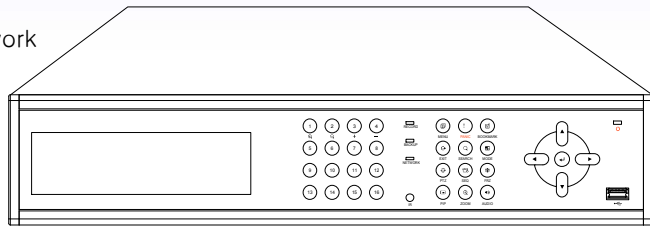

Contents		4 Channel	8 Channel	16 Channel
Compression Algorithm		MPEG4 ASP		
Audio		G.723		
General Feature				
Signal Format		NTSC or PAL (Auto Detect)		
Video	In	4CH	8CH	16CH
	Out	Main, Spot, VGA		
	Loop Out	4CH	8CH	16CH
Video Compression Rate		4 Steps Selectable		
Audio	In	1ch	2ch	4ch
	Out	1ch	1ch	1ch
Alarm	In	4 TTL	8 TTL	16 TTL
	Out	1 Relay Out		2 Relay Out
Storage		2EA S-ATA HDDs		
Recording Speed (NTSC / PAL)	704x480 (704x576)	60(50)fps	60(50)fps	60(50)fps
	704x240 (704x288)	120(100)ips	120(100)ips	120(100)ips
	352x240 (352x288)	240(200)ips	240(200)ips	240(200)ips
Resolution of Motion Detection Area		Area division: 16x12 Detection Division: 32x16		
Search Mode		Date/Time, HDD%, Event Calendar, Bookmark		
Recording Mode		Schedule (Time, Motion, Alarm, T+M, T+A), Holiday, Panic, Pre-Event		
Display Mode		1, 4, 6, 8, 9, 13, 16, PIP, SEQ		
Multi Language		English, German, French, Spanish, Italian, Dutch, Portuguese, Turkish, Russian, Polish		
Zoom		Digital Zoom x2		

Contents	4 Channel	8 Channel	16 Channel
Recording & Playback			
Multi-tasking	Quadplex (Live, Playback, Recording, Network)		
Multi Channel Playback	Available		
Event Log information	Available		
Pre-Alarm	Available		
Alarm / Relay			
Video Loss Alarm	Available		
Motion detection Alarm	Available		
Network			
Remote S/W : Monitoring, Search & Playback, Back-up	Integrated Remote Station		
Internet Explorer Support	Available		
DDNS Support	Yes		
CMS (Central Management Software)	Yes		
Simultaneous remote user access	4 persons		
Network Speed Value	Selectable		
Remote Setup	Available		
Data Export	AVI, JPG, BMP		
Back-Up & Archiving			
CD-RW	Option		
DVD-RW	Yes		
USB Port	USB 2.0		
Others			
Operation	PS2 Mouse / Remote controller / Key Button		
PTZ Control	RS-485		
Menu	GUI		

Detailed specification is subject to change without prior notice.

Appendix D. Remote Control

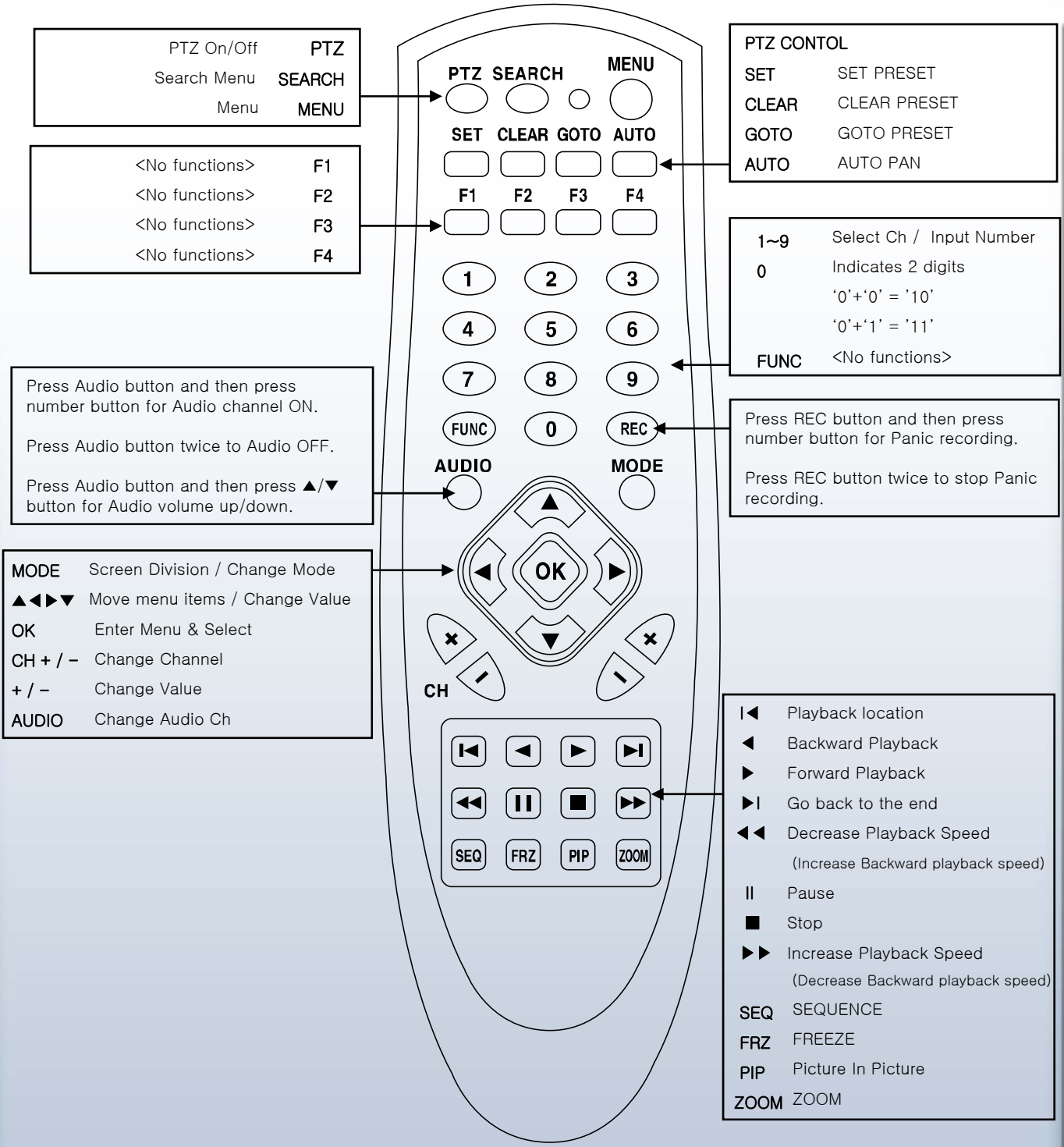

[Infrared Remote Control]

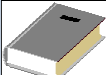
 **<Note>**

Some buttons on the infrared remote control may not be supported, depending on the DVR model.

Digital Video Recorder
Stand-alone DVR

