

Standalone Digital Video Recorder

Premium DVR 4, 8, 16 Channel Models

User`s Manual



MADE IN KOREA

FCC Compliance Statement

Notice to Users: This equipment has been tested and found to comply with the limits for a Class A digital device. Pursuant to Part 15 of the FCC Rules, these limits are designed to provide reasonable protection against harmful interference when the equipment is operated in a commercial environment. This equipment generates uses and can radiate radio frequency energy and, if not installed and used in accordance with the instruction manual, may cause harmful interference to radio communications. Operation of this equipment in a residential area is likely to cause harmful interference in which case the user will be required to correct the interference at own expense.

CAUTION

CHANGES OR MODIFICATIONS NOT EXPRESSLY APPROVED BY THE PARTY RESPONSIBLE FOR COMPLIANCE COULD VOID THE USER'S AUTHORITY TO OPERATE THE EQUIPMENT.

ATTENTION

DES CHANGEMENTS OU DES MODIFICATIONS NON EXPRESSEMENT APPROUVEES PAR LE RESPONSABLE DE LA CONFORMITE POURRAIENT ANNULER L'AUTORISATION DE L'UTILISATEUR A EXPLOITER L'EQUIPEMENT.

The equipment complies with the requirement of FCC CFR 47 PART 15 SUBPART B, Class A.

Explanation of Graphical Symbols



This symbol indicates the presence of important operating and maintenance (servicing) instruction in the literature accompanying the product.

Ce symbole indique la présence d'instructions importantes et de maintenances dans le manuel accompagnant le produit



This symbol indicates the presence of non-insulated "dangerous voltage" within the product's enclosure that may be of sufficient magnitude to constitute a risk of electric shock to persons.

Ce symbole indique la présence de « haute tension » non-isolé dans le produit qui peut avoir pour conséquence un risque de la décharge électrique aux personnes.

	CAUTION RISK OF ELECTRIC SHOCK DO NOT OPEN	
CAUTION : TO REDUCE THE RISK OF ELECTRIC SHOCK, DO NOT REMOVE COVER (OR BACK). NO USER SERVICEABLE PARTS INSIDE. REFER SERVICING TO QUALIFIED SERVICE PERSONNEL.		

	CAUTION RISK OF ELECTRIC SHOCK DO NOT OPEN	
ATTENTION : Pour réduire les risques d'électrocution, ne pas ouvrir et se référer à une personne compétente.		

Warnings

- Installation and servicing should be performed only by qualified and experienced personnel.
- Power off the DVR when connecting cameras, audio, or sensor cables.
- The manufacturer is not responsible for any damage caused by improper use of the product or failure to follow instructions for the product.
- The manufacturer is not responsible for any problems caused by or resulting from the user physically opening the DVR for examination or attempting to fix the unit.
- The manufacturer may not be held liable for any issues with the unit if any labels are removed in the product.

Cautions

- This product has free voltages (100V ~ 240V). See installation instructions before connecting to the power supply.
- This product uses a Lithium battery.
- To avoid any risk of explosion, do not replace the battery on the main board by anything other than a Lithium battery.
- Dispose of used batteries according to the manufacturer's instructions.
- This equipment and all communication wirings are intended for indoor use only.
- To reduce the risk of fire or electric shock, do not expose the unit to rain or moisture.

WEEE(Waste Electrical and Electronic Equipment)

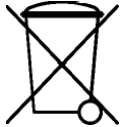

Customers in European Union countries are advised to dispose this product, at the end of its useful life, as per applicable local laws, regulations and procedures.

Important Safeguards

1. Read Instructions

- To reduce the risk of fire or electric shock, do not expose the unit to rain or moisture.

2. Retain Instructions

- The safety and operating instructions should be retained for future reference.

3. Cleaning

- Unplug this equipment from the wall outlet before cleaning it. Do not use liquid aerosol cleaners. Use a damp soft cloth for cleaning.

4. Attachments

- Never add any attachments and/or equipment without manufacturer approval as such additions may result in the risk of fire, electric shock, or other personal injury.

5. Water and/or Moisture

- Do not use this equipment near water or in contact with water.

6. Accessories

- Do not place this equipment on an unstable cart, stand or table. The equipment may fall, causing serious injury to a child or adult and serious damage to the equipment.
- Wall or shelf mounting should follow the manufacturer's instructions and should use a mounting kit approved by the manufacturer.



- Move this equipment and cart combination with care. Quick stops, excessive force and uneven surfaces may cause the equipment and cart combination to overturn.

7. Power Sources

- This equipment should be operated only from the type of power source indicated on the marking label. If not sure the type of power, please consult to distributor or local power company.

8. Power Cords

- Operator or installer must remove power, BNC, alarm and other connections before moving the equipment.

9. Lightning

- For added protection for this equipment during a lightning storm, or when it is left unattended and unused for long periods of time, unplug it from the wall outlet and disconnect the antenna or cable system. This will prevent damage to the equipment due to lightning and power-line surges.

10. Overloading

- Do not overload wall outlets and extension cords to avoid the risk of fire or electric shock.

11. Objects and Liquids

- Never push objects of any kind through openings of this equipment as they may touch dangerous voltage points or short out parts that could result in a fire or electric shock.
- Never spill liquid of any kind on the equipment.

12. Servicing

- Do not attempt to service this equipment yourself. Refer all servicing to qualified service personnel.

13. Damage Requiring Service

- Unplug this equipment from the wall outlet and refer servicing to qualified service personnel under the following conditions:
 - ① When the power-supply cord or the plug has been damaged.
 - ② If liquid is spilled or objects have fallen into the equipment.
 - ③ If the equipment has been exposed to rain or water.
 - ④ If the equipment does not operate normally by following the operating instructions, adjust only those controls that are covered by the operating instructions as an improper adjustment of other controls may result in damage and will often require extensive work by a qualified technician to restore the equipment to its normal operation.
 - ⑤ If the equipment has been dropped or damaged the cabinet.
 - ⑥ When the equipment exhibits a distinct change in performance—this indicates a need for service.

14. Replacement Parts

- When replacement parts are required, ensure the service technician uses replacement parts specified by the manufacturer or that have the same characteristics as the original part. Unauthorized substitutions may result in fire, electric shock, or other hazards.

15. Safety Check

- Upon completion of any service or repairs to this equipment, ask the service technician to perform safety checks to determine that the equipment is in proper operating condition.

16. Field Installation

- This installation should be made by a qualified service person and should conform to all local codes.

17. Correct Batteries

CAUTION

RISK OF EXPLOSION IF BATTERY IS REPLACED BY AN INCORRECT TYPE.
DISPOSE OF USED BATTERIES ACCORDING TO THE INSTRUCTIONS

ATTENTION

RISQUE D'EXPLOSION SI LA BATTERIE EST REMPLACÉE PAR UN TYPE INCORRECT
DISPOSEZ DE BATTERIES EN ACCORS AVEC LES INSTRUCTIONS

18. Operating Temperature

- An operating temperature range is specified so that the customer and installer may determine a suitable operating environment for the equipment.

19. Elevated Operating Ambient Temperature

- If installed in a closed or multi-unit rack assembly, the operating ambient temperature of the rack environment may be greater than room ambient. Therefore, consideration should be given to installing the equipment in an environment compatible with the specified operating temperature range.

20. Reduced Air Flow

- Installation of the equipment in the rack should be such that the amount of airflow required for safe operation of the equipment is not compromised.

21. Mechanical Loading

- Mounting of the equipment in the rack should be such that a hazardous condition is not caused by uneven mechanical loading.

22. Circuit Overloading

- Consideration should be given to connection of the equipment to supply circuit and the effect that overloading of circuits might have on over-current protection and supply wiring. Appropriate consideration of equipment nameplate ratings should be used when addressing this concern.





23. Grounding (Earthing)

- Connection of ground wire is highly recommended to protect the DVR from external electric shock, such as lightning, electrical surge.

Warning

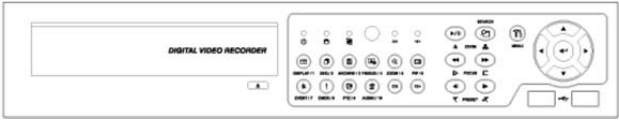
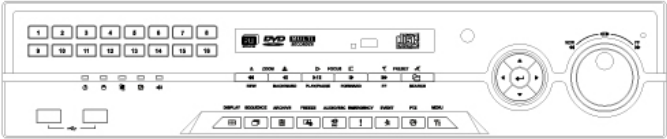
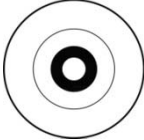
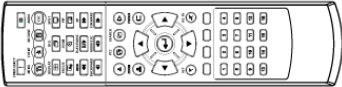
WARRANTY IS VOID IF SEAL OR LABEL IS REMOVED OR DAMAGED.

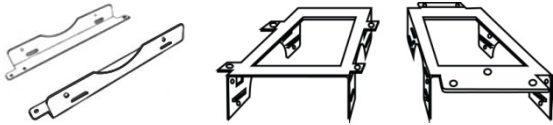
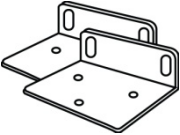
The List of Configuration

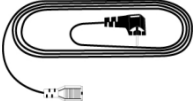
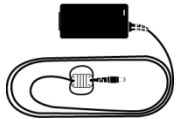
<p>DVR Set</p>	<p>S, A and E(4CH) Type : 4 / 8 / 16CH</p>  <p>B and E(8, 16CH) Type : 4 / 8 / 16CH</p>  <p>C, D, F, G, H and I Type : 4 / 8 / 16CH</p> 
<p>Manual / CMS CD</p>	
<p>Remote Controller</p>	
<p>Manual</p>	
<p>Screws</p>	
<p>HDD Brackets</p>	
<p>Rack Bracket (Except S, A, B and E Type)</p>	
<p>Data Cable</p>	
<p>Power Cable</p>	
<p>Adapter (Except G 8/16CH Type)</p>	

Operation Precautions

● Power Off

- Do not turn DVR off, or plug off the power adapter while DVR is in operation (record/playback). Otherwise, it may cause permanent damage to the equipment. Please click (↵) SETUP>SYSTEM>Shutdown sequentially and then remove the power after DVR is shut down completely. It is safe to wait for 5 seconds before turning the power on again.
- Do not turn DVR off, or plug off the power adapter while External storage device (e.g., USB memory stick, removable external hard disk and the like) in use. Otherwise, it may cause permanent damage to the equipment. Make sure that the power switch is in the “ON” position until data storage is completed. Please be aware that removing the storage device cause the same damage to the equipment.
- Do not turn DVR off, or plug off the power adapter during the format of the hard disk. Otherwise, it may cause permanent damage to the equipment. Make sure that the power switch is in the “ON” position until the formatting of the disk is completed.

● HDD Installation / Addition / Moving / Replacement / Removal

- For installation/addition/replacement/Removal of HDD (DVD-RW), make sure that DVR is turned off. Otherwise, it may cause permanent damage to the HDD (DVD-RW).
- When wish to power DVR off, please click (↵) SETUP>SYSTEM>Shutdown sequentially and then remove the power after DVR is shut down completely.
- **Installation/Addition/Moving/Replacement:** Start ‘HDD initialization’ including formatting. Otherwise, DVR would not recognize the hard disk and may begin to function abnormally. Please follow the below procedure for ‘HDD initialization’.
 - ① (Date/Time setup) Set up the current date and time (SETUP>SYSTEM>Admin>Date/Time).
 - ② (Initialization of system setup) All setup values are restored to original factory default settings. (SETUP>SYSTEM>Information>Status>Setup>Default).
 - ③ (HDD format) HDD format is done by SETUP>SYSTEM>Admin>Storage>Format. If there are more than two HDDs, each must be formatted, separately. When the format is completed, DVR will auto-reboot.
- **Removal:** Follow the Remove procedure even when a pre-installed hard disk has been removed.
 - SETUP>SYSTEM>Admin>Storage>Format, click (↵) ‘Removed’ item under the discrete Format headings of a corresponding HDD to discard ‘HDD’ item. When the Remove procedure is completed, DVR will auto-reboot.

● Date / Time Change

- Any change in Date/Time is immediately applied onto live video (LIVE), but the date/time when the recording was done are not changed.
- Make sure to reboot DVR after adjusting the Date/Time.
- Also, do not forget to execute SETUP>SYSTEM>Shutdown in sequence before reboot.

● Upgrade

- Do not upgrade until install a hard disk drive. Make sure that upgrade when the hard disk drive is in proper operation.

● Using a Mouse

- **Left mouse button:** have the same function as **Enter (↵)** on the Front panel of DVR.
- **Central button (wheel):** have the same function as **Search** key on the Front panel of DVR(display search menu).
- **Right mouse button:** display a number of ‘Function keys’ (please see ‘Input Device and Screen Icons>Using a mouse’ in this manual).

● PLAY / PAUSE Key

- Press the **PLAY/PAUSE** key to one-touch playback on the viewing screen (playback the recorded video from the last one minute).
- Every time pressing the **PLAY/PAUSE** key during playback mode, it is changed to ‘1X PLAY’ and ‘PAUSE’. The displayed sign on the screen also changes from ► to II.
- If wish to change mode (1X PLAY, REW, FF, BACKWARD, FORWARD) during playback, always press the **PLAY/PAUSE** key first (please see if the sign II is shown on the screen).
- Press the **PLAY/PAUSE** key to back up. Make sure that the backup is done in ‘PAUSE’ mode.

● Camera Title

- Camera Title displayed in Record and Playback modes of DVR is set to CAM1 ~CAM16. Registering camera title in setup menu (DEVICES>Camera/PTZ>Title) is to make every setup process easier.

Table of Contents

1. PRODUCT FEATURES	11	4.3 DISPLAY	44
1.1 Unpacking.....	11	4.3.1 OSD	44
1.2 Service	11	4.3.2 Main Monitor.....	45
1.3 System Connection Diagram	11	4.3.3 Multi Spot.....	45
2. INSTALLATION	22	4.3.4 Video In / Out.....	47
2.1 Hard disk and DVD-RW Installation	22	4.4 DEVICES	47
2.1.1 SATA Port	22	4.4.1 Network.....	48
2.1.2 Internal SATA Storage	23	4.4.2 Camera / PTZ	52
2.1.3 e-SATA External Storage.....	23	4.4.3 Audio	53
2.1.4 HDD Installation.....	23	4.4.4 Alarm In.....	53
2.1.5 Maximum HDD Capacity.....	23	4.4.5 Alarm Out.....	54
2.1.6 DVD-RW Installation.....	24	4.4.6 Serial In	54
2.2 Connector Wiring	24	4.5 RECORD	55
2.2.1 Video-In/Loop Out Connections	24	4.5.1 Setting	55
2.2.2 HD-SDI Input Signal detection	24	4.5.2 Schedule	57
2.2.3 Monitor Connections	24	4.5.3 Pre Alarm	58
2.2.4 HDMI Connections	25	4.5.4 Motion Detection.....	59
2.2.5 Audio Connections	25	4.5.5 Holiday	59
2.2.6 TCP/IP(Ethernet) Connections.....	25	4.6 LINK	60
2.2.7 Alarm Connections(TTL)	25	4.6.1 Alarm In.....	60
2.2.8 Master Alarm.....	26	4.6.2 Motion Event.....	61
2.2.9 Alarm Connections	26	4.6.3 Video Loss	61
2.2.10RS-485/422 Connections	26	4.6.4 Serial In	62
2.2.11RS-485 Over Coax Connection	26	4.6.5 System Event.....	63
2.2.12USB Connections	26	4.6.6 Popup Link.....	63
2.2.13RS-232 Connections	26	5. OPERATION INSTRUCTION	64
2.2.14Grounding (Earthing).....	26	5.1 Viewing	64
2.2.15Factory Reset Switch.....	26	5.1.1 First Image	64
2.2.16Power Supply connections	27	5.1.2 View Format.....	65
2.2.17Connections Guideline	27	5.1.3 Digital Zoom	65
3. INPUT DEVICE AND SCREEN ICONS	28	5.1.4 Freeze Live Image	65
3.1 Key and LEDs	28	5.1.5 Pan / Tilt Control	65
3.2 Camera Select Keys for 16 Channel DVR....	30	5.1.6 System Log.....	67
3.3 Front Panel	31	5.1.7 Key Lock	67
3.4 Using a Remote Controller.....	31	5.1.8 Emergency Recording.....	67
3.5 Using a Mouse.....	32	5.2 Search.....	67
3.6 Screen Icon.....	32	5.2.1 Date / Time Search	68
4. SETUP	33	5.2.2 Calendar Search.....	68
4.1 Login / Logout	33	5.2.3 Event Search	69
4.2 SYSTEM	34	5.3 Playback	70
4.2.1 Information.....	34	5.4 One-touch Playback	71
4.2.2 Admin	37	5.5 Digital Zoom in Playback	71
4.2.3 Account.....	40	5.6 Archive.....	71
4.2.4 System Log	43	5.7 Menu Bar.....	72
4.2.5 Exit.....	43	5.8 Alarm Out Control.....	73
4.2.6 Shutdown	43		

6. CMS PRO	75	7. ICMS VIEWER	112
6.1 CMS Pro Features	75	7.1 System Recommendations	112
6.1.1 Introduction	75	7.2 Program Installation	112
6.1.2 Features	75	7.3 Login	113
6.1.3 System Requirements	75	7.4 Watch Mode	114
6.2 Installation	76	7.4.1 Log-in Screen	114
6.2.1 Software Installation	76	7.4.2 Local Setting	114
6.2.2 Login	77	7.5 Live View	117
6.3 Menu	78	7.5.1 Connection	117
6.4 Setup	79	7.5.2 Display Mode	118
6.4.1 Local Setup - Device	79	7.5.3 Health Check	119
6.4.2 Device Group Setup	81	7.5.4 PTZ Control	120
6.4.3 Local Setup - Environment	82	7.5.5 System Log	120
6.4.4 Local Setup - Account	85	7.6 Search Mode	121
6.4.5 Local Setup – E-map	86	7.6.1 Date/Time Search	121
6.4.6 Remote Device Setup	88	7.6.2 Event Search	122
6.4.7 Change Password	89	7.6.3 POS/ATM	123
6.4.8 Help	89	7.7 Disconnection	124
6.5 View	90	7.8 Uninstall	125
6.5.1 Server List	90	8. XCMS VIEWER	127
6.5.2 Remote Device System Log	90	8.1 Program Installation	127
6.5.3 Remote Device Event Log	91	8.1.1 System Recommendations	127
6.5.4 CMS System Log	92	8.1.2 Program Installation Method	127
6.5.5 Health Check	92	8.2 Login	128
6.5.6 Show All Windows	94	8.3 Watch Mode	128
6.6 Application	94	8.3.1 Login Screen	128
6.6.1 Search	94	8.3.2 Local Setting	129
6.6.2 Exit	95	8.3.3 Live	132
6.7 Live (Live Video Monitoring System)	95	8.4 Search Mode	135
6.7.1 Overview	95	8.4.1 Date/Time Search	135
6.7.2 Live Monitor Menu	95	8.4.2 Event Search	136
6.7.3 Screen Layout Control	102	8.4.3 POS/ATM	137
6.7.4 Change Division Display	102	8.5 Disconnection	138
6.7.5 Sequencing	103	8.6 Uninstall	139
6.7.6 Audio Volume Control	103	9. CMS WEB CLIENT PRO	141
6.8 Search	104	9.1 System Requirements	141
6.8.1 Overview	104	9.2 Setup and Login	141
6.8.2 Time Bar Search	104	9.3 Live Display	142
6.8.3 Event Search	106	9.4 Search Screen	143
6.8.4 POS/ATM Search	106	9.5 PTZ Control	144
6.8.5 Thumbnail Search	107	9.6 Capture	145
6.8.6 Smart Search	107	10. CMS MOBILE VIEWER	147
6.9 E-Map	108	10.1 iPhone Mobile	147
6.9.1 Overview	108	10.1.1 System Requirements	147
6.9.2 Controls	108	10.1.2 Installation	147
6.9.3 E-map Camera – Instant Playback	108	10.1.3 Site Registration	148
6.9.4 Alarm In/Out Control	109	10.1.4 Connection	149
6.9.5 Audio	109	10.1.5 Live View (Portrait View)	150
6.10 Uninstalling CMS Pro	110		

10.1.6 Live View (Landscape View)	151	12.4.2 Schedule Setup	184
10.1.7 PTZ Control	152	12.5 Setup	184
10.1.8 Search	152	12.5.1 Title	184
10.1.9 Snapshot gallery	154	12.5.2 Port Setting	185
10.1.10 Setting	155	12.5.3 OSD Display	185
10.1.11 Uninstallation	155	12.5.4 Pattern Setting	185
10.2 iPad Mobile	156	12.6 Search	188
10.2.1 System Requirements	156	13.HD-SDI VIDEO SIGNAL ACCESSORIES . 191	
10.2.2 Installation	156	13.1 HSC1100	191
10.2.3 Site Registration	158	13.1.1 Introduction	191
10.2.4 Connection	158	13.1.2 Features	191
10.2.5 Live View (Portrait View)	159	13.1.3 Technical Specification	191
10.2.6 Live View (Landscape View)	160	13.1.4 Unpacking	191
10.2.7 PTZ Control	160	13.1.5 Service	191
10.2.8 Search	161	13.1.6 System Dimension Diagram	191
10.2.9 Snapshot gallery	162	13.1.7 System Connection Diagram	192
10.2.10 Setting	163	13.1.8 Cable	192
10.2.11 Uninstallation	163	13.1.9 Display	192
10.3 Android Phone (mViewer Pro)	164	13.2 HSC1200	193
10.3.1 System Requirements	164	13.2.1 Introduction	193
10.3.2 Installation	164	13.2.2 Features	193
10.3.3 Site Registration	165	13.2.3 Technical Specification	193
10.3.4 Connection	166	13.2.4 Unpacking	193
10.3.5 Live View (Portrait View)	166	13.2.5 Service	193
10.3.6 Live view (Landscape View)	167	13.2.6 System Dimension Diagram	193
10.3.7 PTZ control	168	13.2.7 Connector Wiring	194
10.3.8 Alarm Out Control	169	13.2.8 Cable	194
10.3.9 Search	169	13.2.9 Operation Key and Screen Display Information	194
10.3.10 Snapshot Gallery	170	13.3 HSC2110	195
10.3.11 Setting	171	13.3.1 Introduction	195
10.3.12 Uninstallation	171	13.3.2 Features	195
11.KEYBOARD CONTROLLER	173	13.3.3 Technical Specification	195
11.1 Connection	173	13.3.4 Unpacking	195
11.1.1 Configuration Diagram	173	13.3.5 Service	195
11.1.2 USB Connection	173	13.3.6 System Dimension Diagram	195
11.2 Keyboard Setup in DVR	173	13.3.7 Connector Wiring	196
11.3 Keyboard Configuration	174	13.3.7.2 RS-485 Connection	196
11.4 Setup	175	13.3.7.3 Power Supply Connection	196
11.4.1 DVR Control Mode	175	13.3.8 PTZ Control	196
11.4.2 Speed Dome Setup	176	13.3.9 Cable	196
11.4.3 Joystick Calibration	176	13.3.10 Display	197
11.5 Operation	176	13.4 HSC2410	197
11.5.1 DVR/SPD Mode Conversion	176	13.4.1 Introduction	197
11.5.2 DVR Control Mode	176	13.4.2 Features	197
11.5.3 SPD Control Mode (Speed Dome) ...	178	13.4.3 Technical Specification	197
12.SERIAL IN (POS)	181	13.4.4 Unpacking	197
12.1 Usage of Serial-In Function	181	13.4.5 Service	197
12.2 Connection Method	181	13.4.6 System Dimension Diagram	198
12.3 Connection Diagram	181	13.4.7 Connector Wiring	198
12.4 Link	183	13.4.8 Cable	198
12.4.1 Link Setup	183	13.4.9 Display	199

13.5 HSR1110	199
13.5.1 Introduction	199
13.5.2 Features	199
13.5.3 Technical Specification	199
13.5.4 Unpacking	199
13.5.5 Service.....	199
13.5.6 System Dimension Diagram.....	200
13.5.7 Connector Wiring	200
13.5.8 Cable.....	200
13.5.9 Display.....	200
13.6 HSR1440	201
13.6.1 Introduction	201
13.6.2 Features	201
13.6.3 Technical Specification	201
13.6.4 Unpacking	201
13.6.5 Service.....	201
13.6.6 System Dimension Diagram.....	201
13.6.7 Connector Wiring	202
13.6.8 Cable.....	202
13.6.9 Display.....	202
13.7 HQS1004	203
13.7.1 Introduction	203
13.7.2 Features	203
13.7.3 Technical Specification	203
13.7.4 Unpacking	203
13.7.5 Service.....	203
13.7.6 System Dimension Diagram.....	203
13.7.7 Connector Wiring	204
13.7.8 Cable.....	204
13.7.9 Display.....	204
13.8 HFO1100 & HFO1200	205
13.8.1 Introduction	205
13.8.2 Features	205
13.8.3 Technical Specification	205
13.8.4 Unpacking	205
13.8.5 Service.....	205
13.8.6 System Dimension Diagram.....	206
13.8.7 Connector Wiring	206
13.8.8 Cable.....	207
13.8.9 Display.....	207

1. Product Features

1.1 Unpacking

- This equipment is an electronic appliance, so it should be handled with special care.
- After unpacking, please check if all the following items are included.
 - DVR Main body
 - **S Type**: Power Supply Adapter (DC 12V, 3A) and Power Supply Cable
 - **A, B and E(4CH) Type**: Power Supply Adapter (DC 12V, 5A) and Power Supply Cable
 - **C, D, E(8, 16CH), F, G(4CH), H and I Type**: Power Supply Adapter (DC 12V, 6.67A) and Power Supply Cable
 - **G(8, 16CH) Type**: Power Supply Cable
 - Remote Control With 2 AAA batteries
 - Installation CD (CMS Software & User's Manual)
 - Manual

1.2 Service

- If there is any problem in the product, please refer servicing to a supplier or a distributor with qualified service personnel.

Warning

WARRANTY IS VOID IF SEAL OR LABEL IS REMOVED OR DAMAGED.

1.3 System Connection Diagram

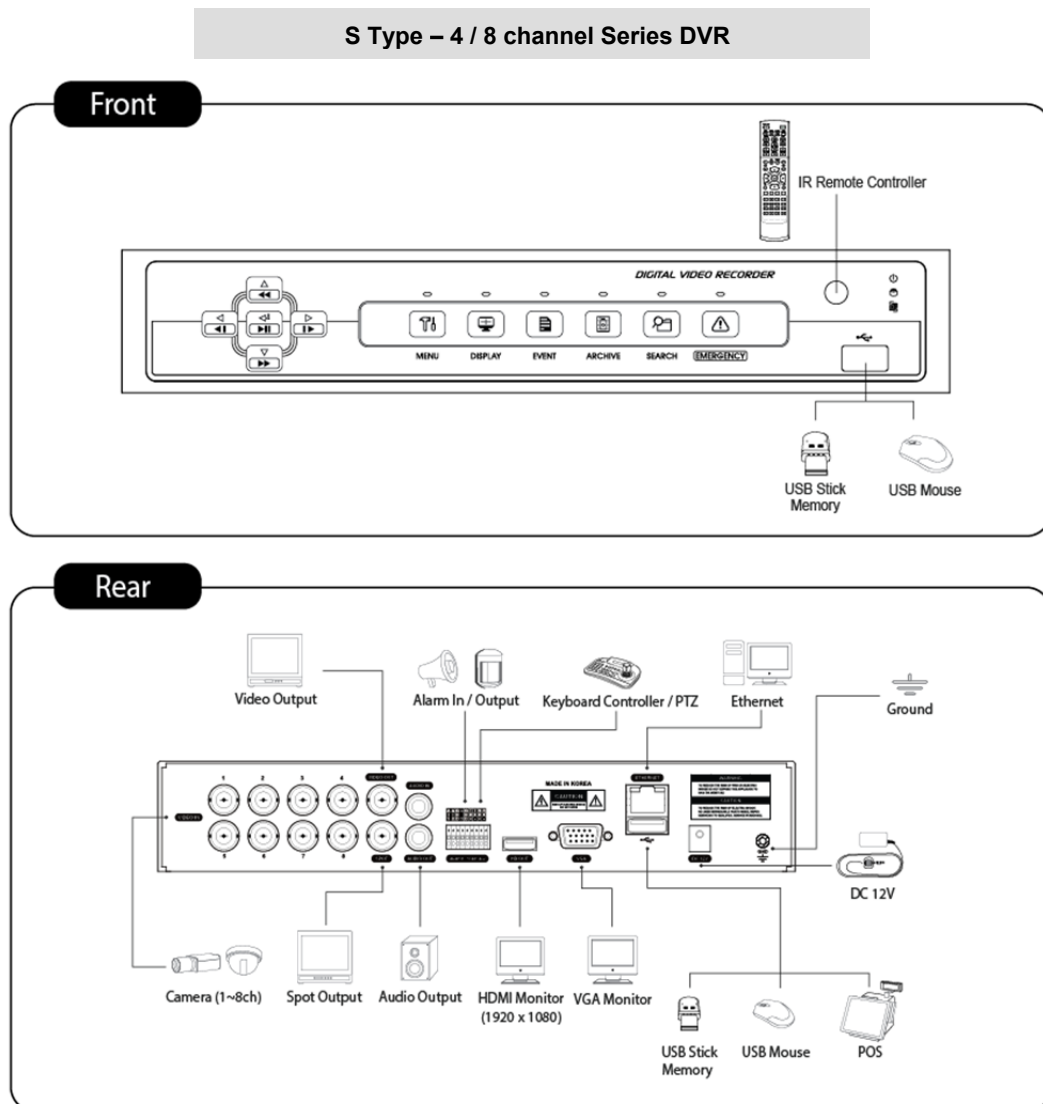

A Type – 4 / 8 / 16 channel Series DVR

Front

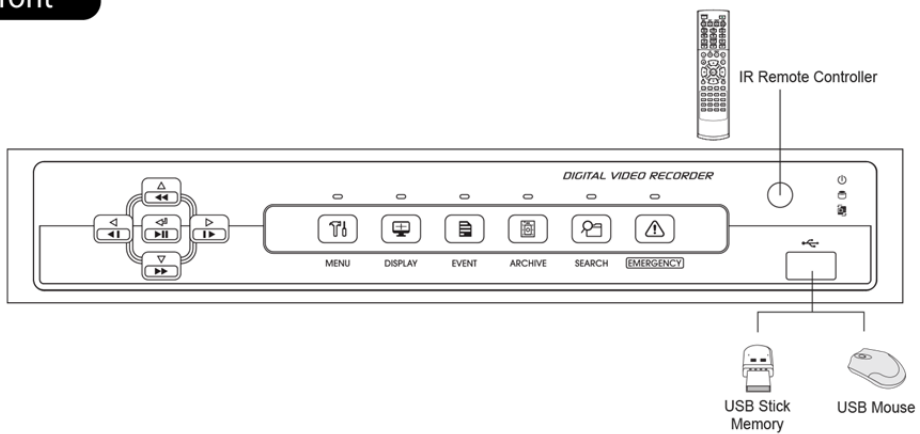

Rear

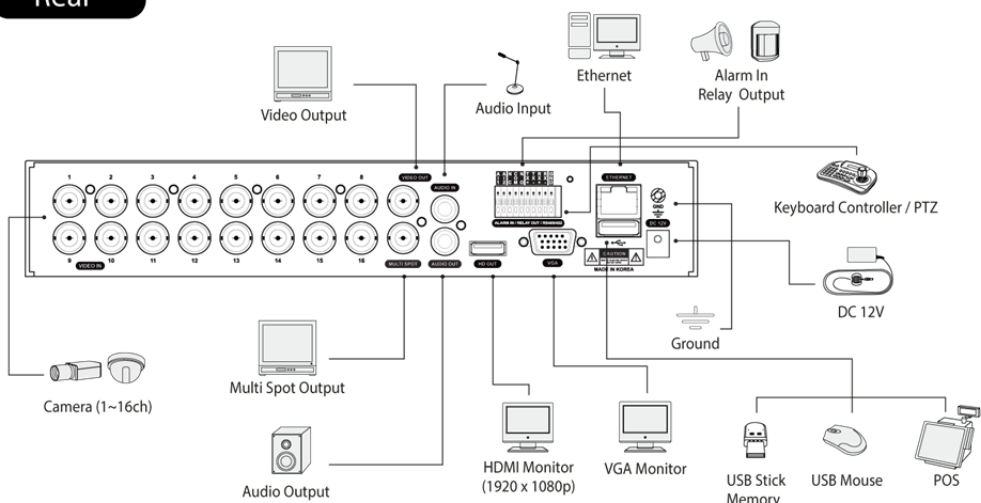

B Type – 4 / 8 / 16 channel Series DVR

Front

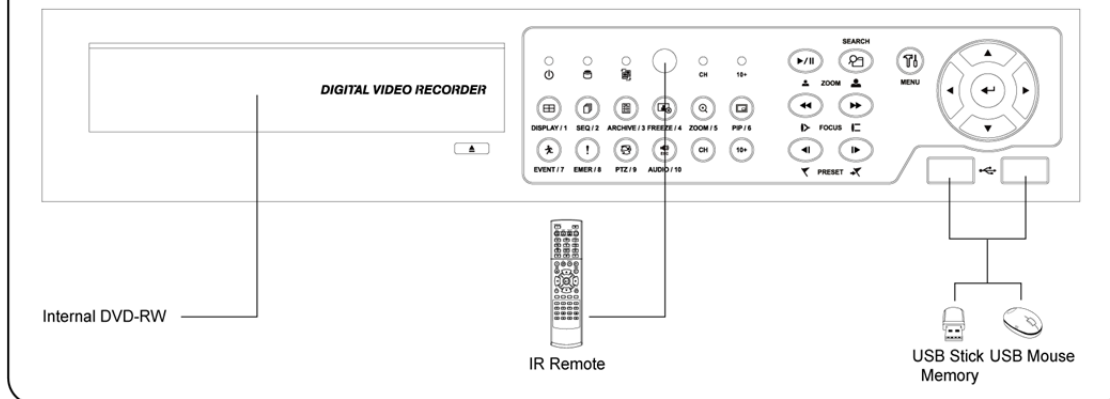

Rear

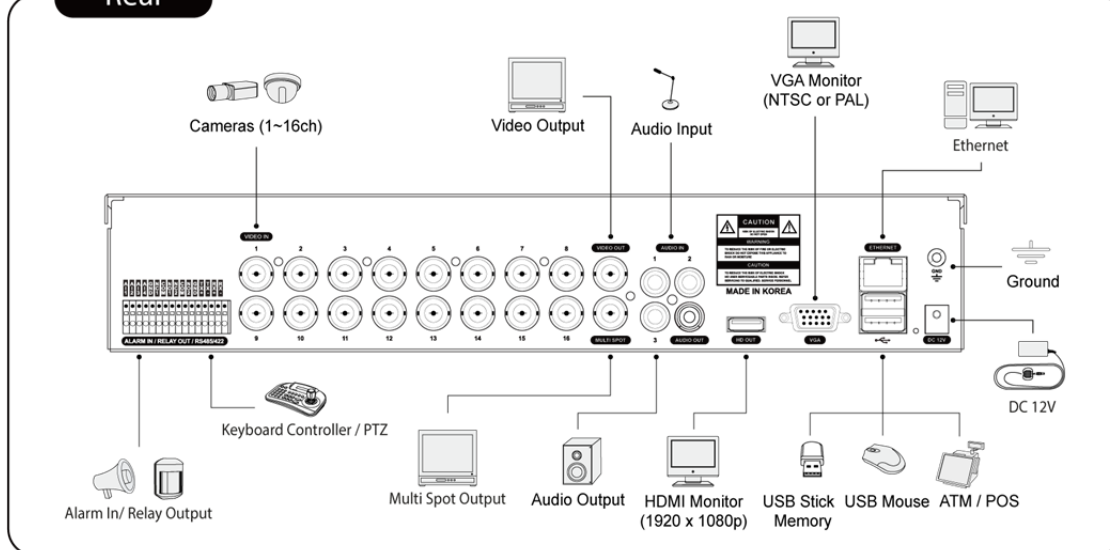

C Type – 4 / 8 / 16 channel Series DVR

Front

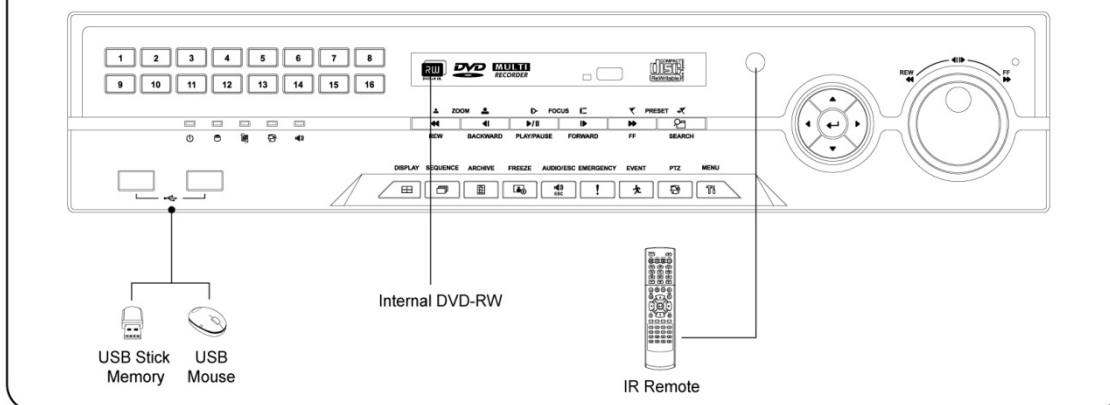

USB Stick Memory
USB Mouse

Internal DVD-RW

IR Remote

Rear

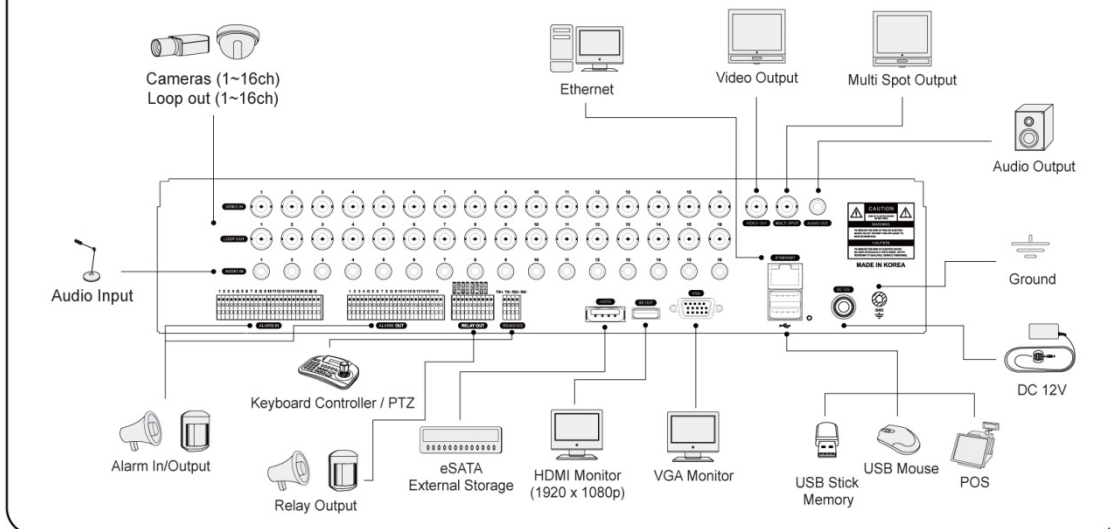

Cameras (1~16ch)
Loop out (1~16ch)

Ethernet

Video Output

Multi Spot Output

Audio Output

Audio Input

Ground

DC 12V

Alarm In/Output

Keyboard Controller / PTZ

Relay Output

eSATA
External Storage

HDMI Monitor
(1920 x 1080p)

VGA Monitor

USB Stick
Memory

USB Mouse

POS

D Type – 4 / 8 / 16 channel Series DVR

Front

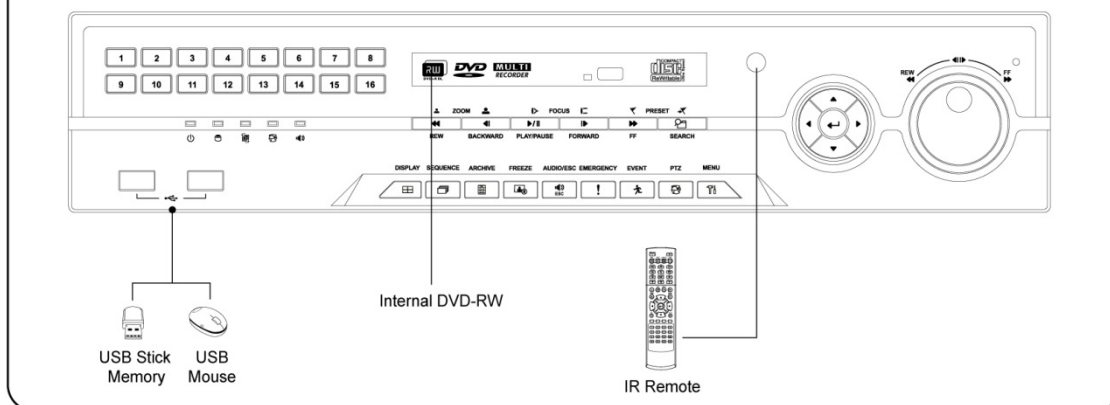

Rear

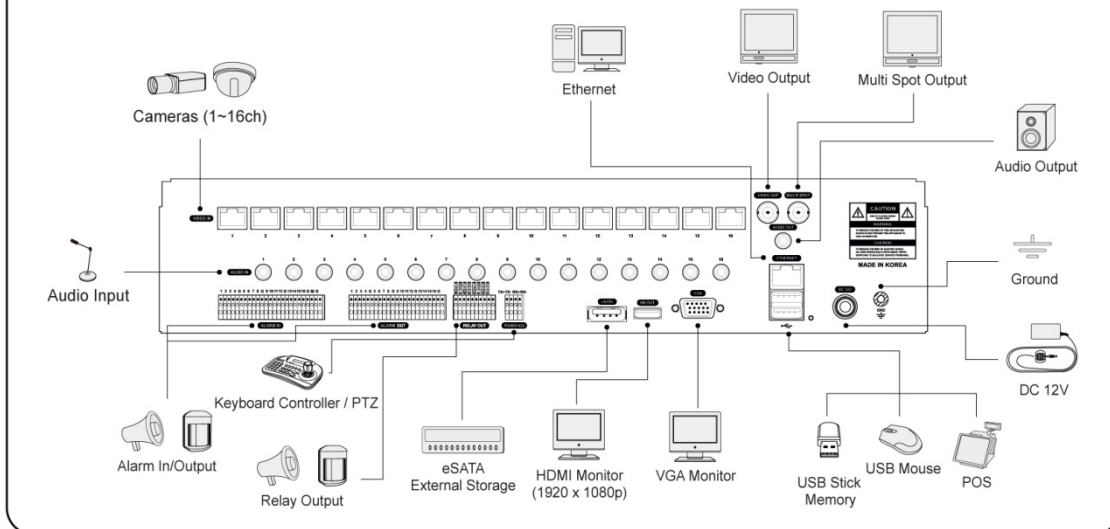

E (4CH) Type – 4 channel Series HD-SDI DVR

Front

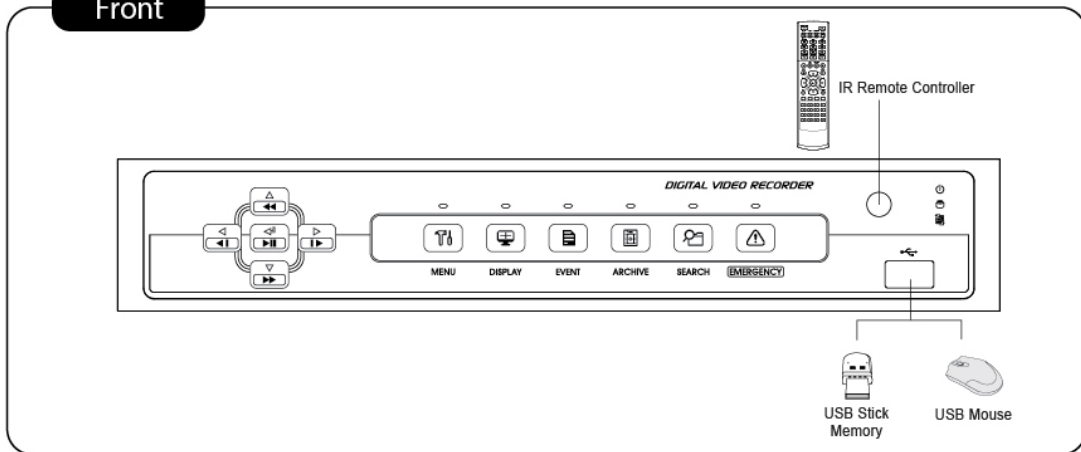

Rear

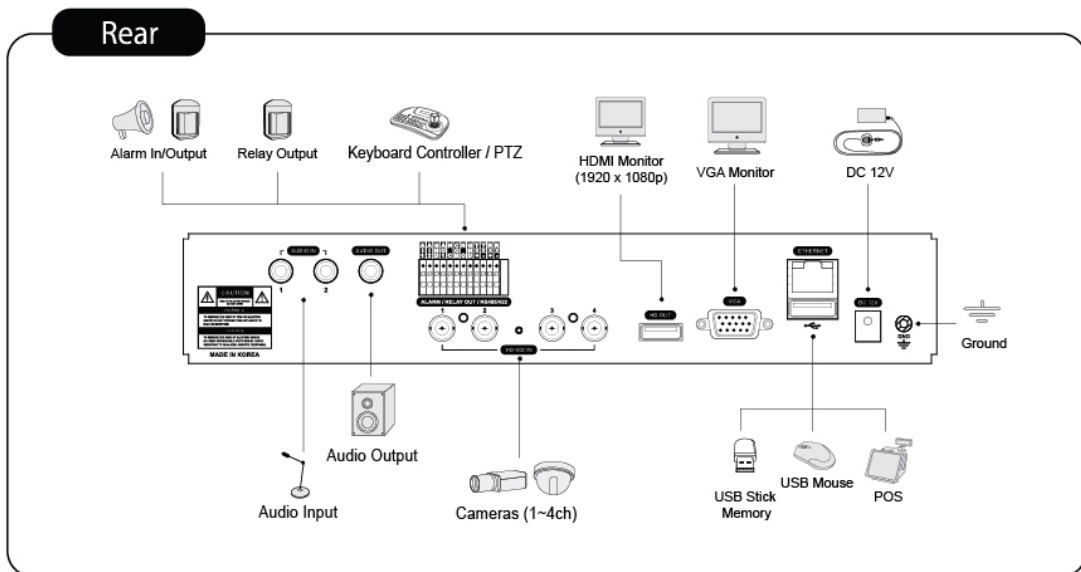

E (8, 16CH) Type – 8 / 16 channel Series HD-SDI DVR

Front

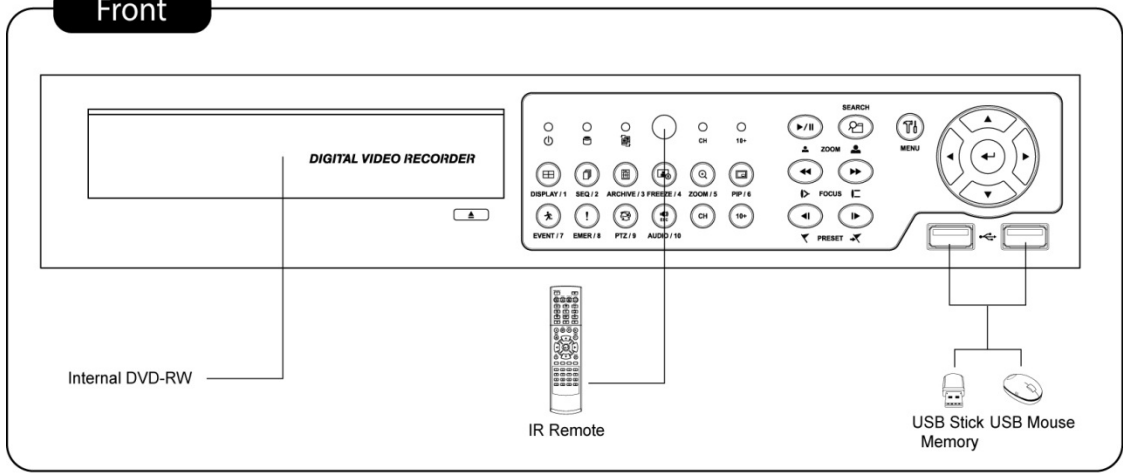

Rear

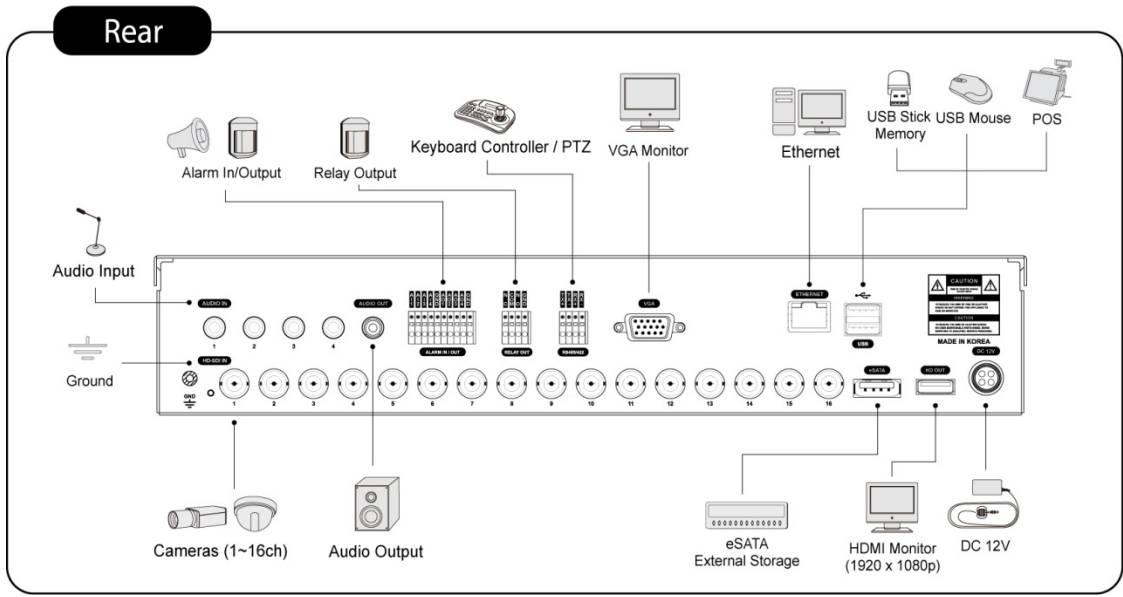

F Type – 4 / 8 / 16 channel Series HD-SDI DVR

Front

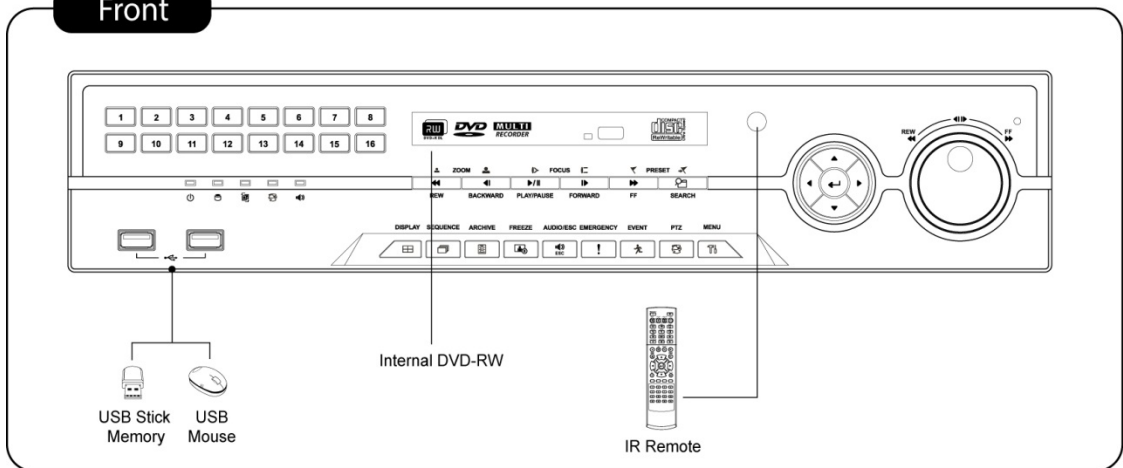

USB Stick Memory USB Mouse

Internal DVD-RW

IR Remote

Rear

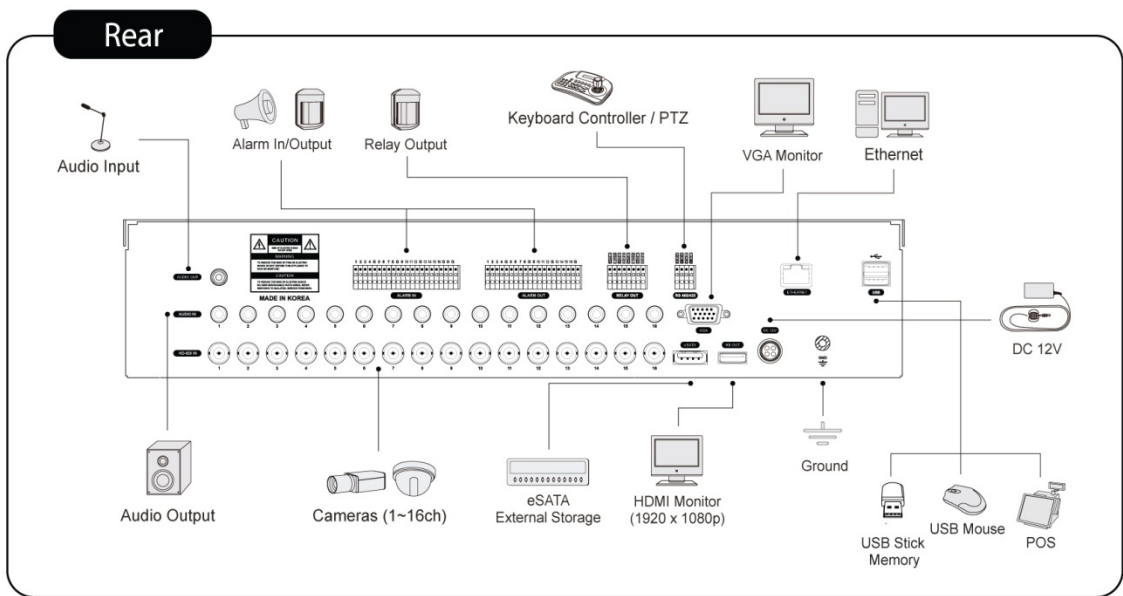

Audio Input

Alarm In/Output

Relay Output

Keyboard Controller / PTZ

VGA Monitor

Ethernet

Audio Output

Cameras (1~16ch)

eSATA External Storage

HDMI Monitor (1920 x 1080p)

Ground

DC 12V

USB Stick Memory

USB Mouse

POS

G Type – 4 channel Series HD-SDI DVR

Front

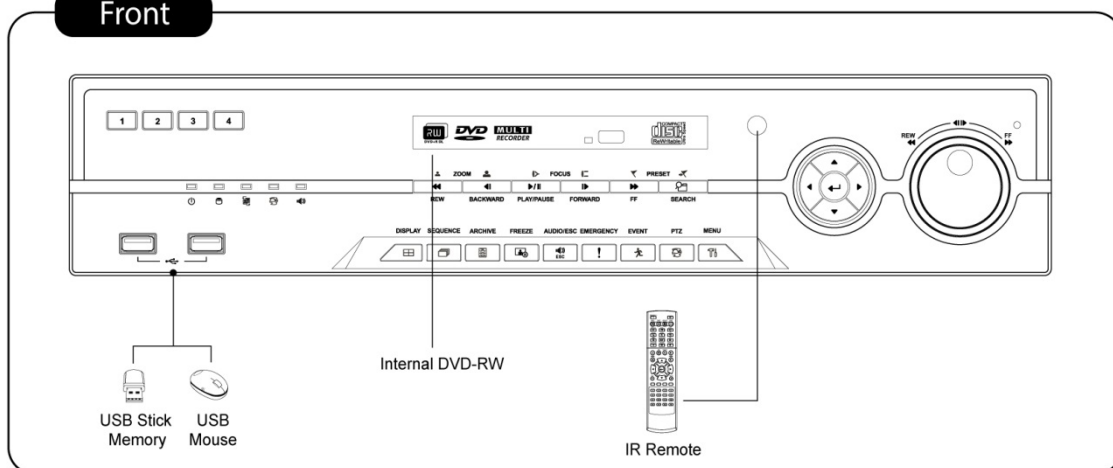

Rear

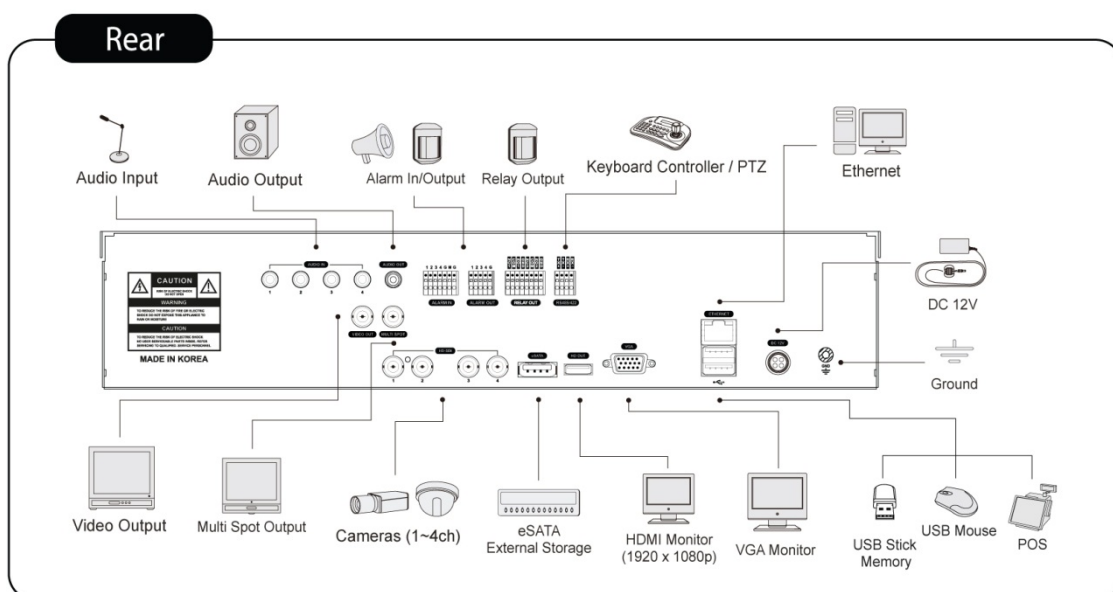

H Type – 4 channel Series HD-SDI DVR

Front

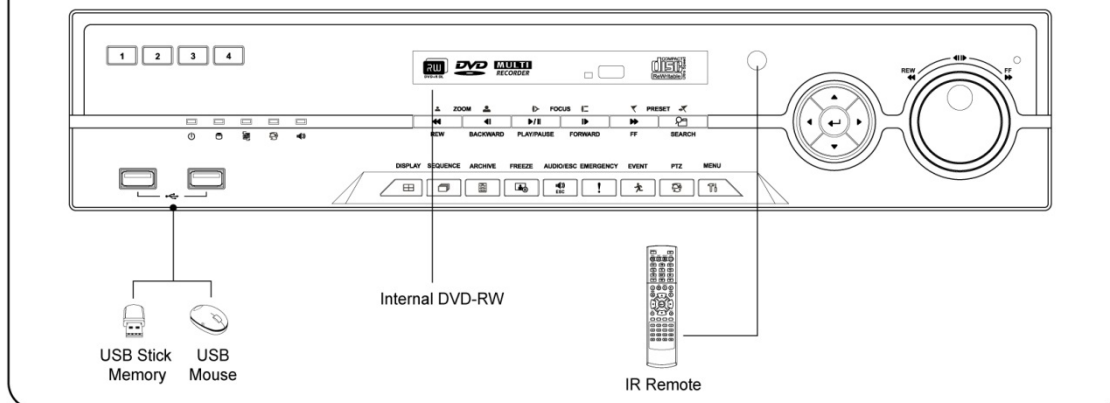

Rear

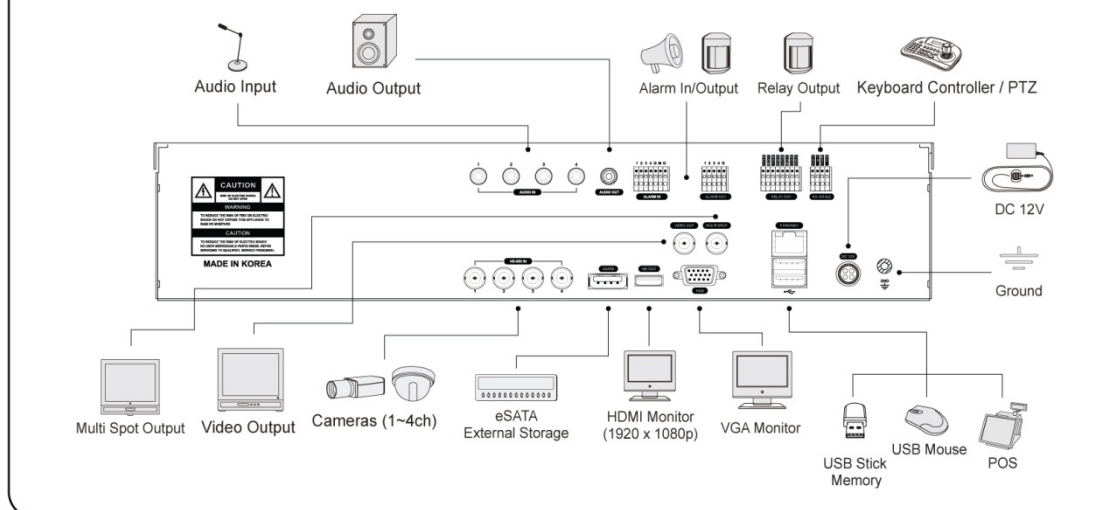

I Type – 4 + 4 channel Series Hybrid DVR

Front

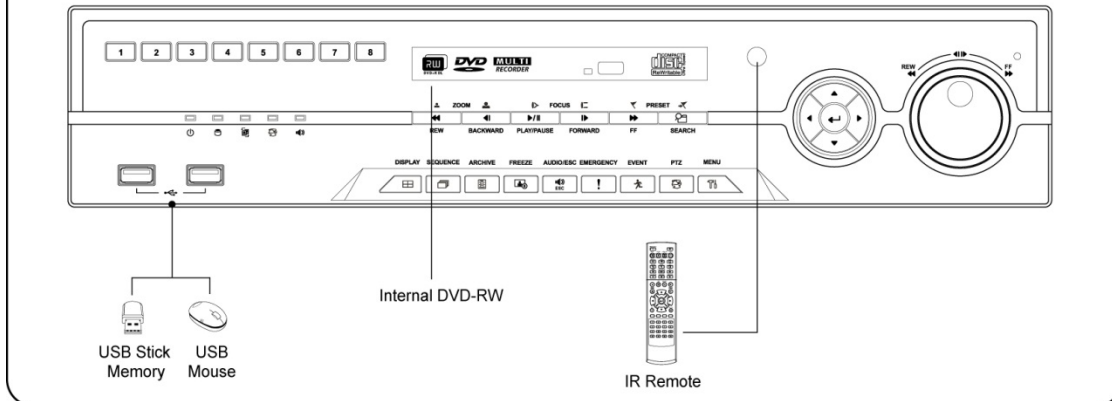

Rear

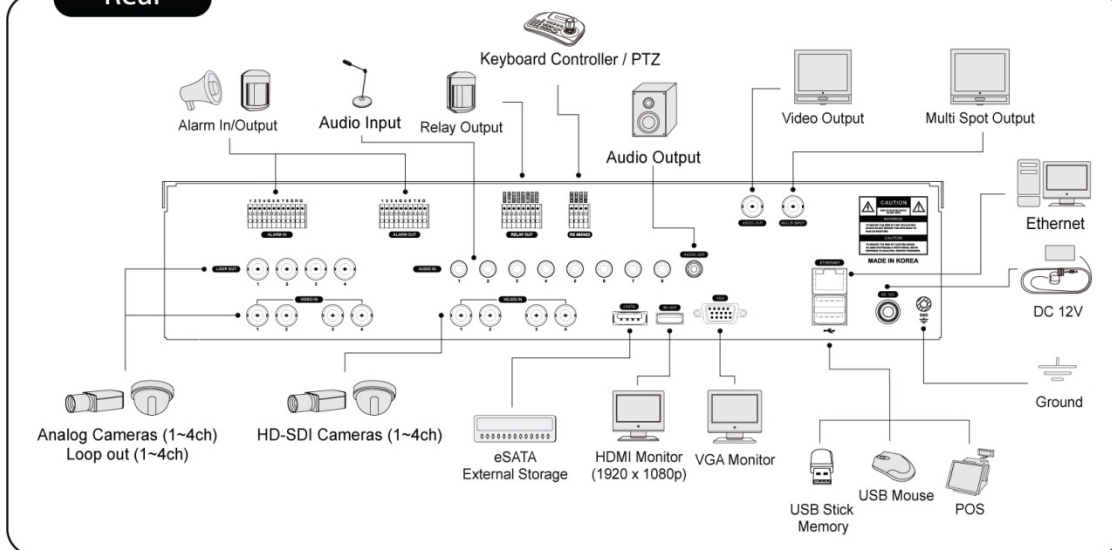

2. Installation

2.1 Hard disk and DVD-RW Installation

2.1.1 SATA Port

- When installing HDDs, make sure to connect from SATA 1 Port.
- **S and E(4ch) Type**
 - Main substrate of this DVR has one SATA port: it is indicated as SATA 1.
- **A Type**
 - Main substrate of this DVR has two SATA port: it is indicated as SATA 1 and 2.
- **B and E(8, 16CH) Type**
 - Main substrate of this DVR has three SATA port: it is indicated as SATA 1, 2 and 3.
 - Please mount DVD-RW at the **SATA 3 port**.
- **C, D, F, G, H and I Type**
 - Main substrate of this DVR has five SATA ports: they are indicated as SATA 1, 2, 3, 4 and SATA 5.
 - Please mount DVD-RW at the **SATA 5 port**.
- Up to five SATA devices (HDD and DVD-RW) are able to be connected to the SATA ports in serial; however the devices must be connected onto correct SATA port.
- Refer to the table below to mount HDDs and DVD-RW.

S and E (4CH) Type

4 / 8 CH DVR	Storage		SATA 1 Port	
	HDD			
	1		HDD	

A Type

4 / 8 / 16 CH DVR	Storage		SATA 1, 2 Port	
	HDD		1	2
	1		HDD	---
	2		HDD	HDD

B and E (8, 16CH) Type

4 / 8 / 16 CH DVR	Storage		SATA 1, 2, 3 Port		
	HDD	DVD-RW	1	2	3
	1	1	HDD	---	DVD-RW
	2	1	HDD	HDD	DVD-RW
	2	0	HDD	HDD	---

C, D, F, G, H and I Type

4 / 8 / 16 CH DVR	Storage		SATA 1, 2, 3, 4, 5 Port				
	HDD	DVD-RW	1	2	3	4	5
	1	1	HDD	---	---	---	DVD-RW
	2	1	HDD	HDD	---	---	DVD-RW
	3	1	HDD	HDD	HDD	---	DVD-RW
	4	1	HDD	HDD	HDD	HDD	DVD-RW
4	0	HDD	HDD	HDD	HDD	---	

2.1.2 Internal SATA Storage

- **C, D, F, G, H and I Type** DVR have 5 internal SATA Ports.
- 1-4 SATA Port: It is designed to mount HDD. Connect from SATA 1 port when installing HDDs.
- 5 SATA Port: Please mount DVD-RW.
- Only one DVD-RW can be installed among the SATA Ports.

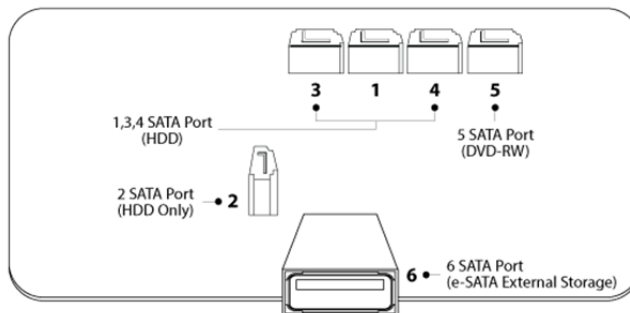

2.1.3 e-SATA External Storage (C, F, G, H and I Type)

- These series DVRs have one external SATA Port; the picture above shows external **SATA 6 Port**.
- 6 SATA Port: It is designed to mount 4HDDs per each external SATA Port.

2.1.4 HDD Installation

- Securely fix a hard disk by using bracket and screws provided herewith.
- Please do not use any different hard disk cables (data cable and power supply cable) other than ones we provide.
- Otherwise, it may cause damage to the hard disk.

CAUTION

INSTALL HARD DISK AFTER DVR POWER IS OFF. OTHERWISE, IT MAY CAUSE PERMANENT DAMAGE TO THE HARD DISK. TO TURN OFF DVR, PLEASE CLICK (←) SETUP>SYSTEM>SHUTDOWN. ALSO, WAIT FOR 5 SECONDS BEFORE PLUGGING IN POWER SUPPLY AGAIN.

CAUTION

- FOR INSTALLATION/ADDITION/REPLACEMENT/REMOVAL OF HDD (DVD-RW), MAKE SURE THAT DVR IS TURNED OFF. OTHERWISE, IT MAY CAUSE PERMANENT DAMAGE TO THE HDD (DVD-RW)
- **INSTALLATION/ADDITION/MOVING/REPLACEMENT:** USER SHOULD START 'HDD INITIALIZATION' INCLUDING FORMATTING. OTHERWISE, DVR WON'T RECOGNIZE THE HARD DISK AND MAY BEGIN TO FUNCTION ABNORMALLY. PLEASE FOLLOW THE BELOW PROCEDURE FOR 'HDD INITIALIZATION'.
 - ① (DATE/TIME SETUP) SET UP THE CURRENT DATE AND TIME (SETUP>SYSTEM>ADMIN>DATE/TIME)
 - ② (INITIALIZATION OF SYSTEM SETUP) ALL VALUES IN SETUP ARE RESTORED TO FACTORY DEFAULT SETTINGS. – (SETUP>SYSTEM>INFORMATION>STATUS>SETUP>DEFALUT)
 - ③ (HDD FORMAT) HDD FORMAT IS DONE BY SETUP>SYSTEM>ADMIN>STORAGE>FORMAT. IF THERE ARE MORE THAN TWO HDDS, EACH MUST BE FORMMATED SEPARATELY. WHEN THE FORMAT IS COMPLETED, DVR WILL AUTO-REBOOT.
- **REMOVAL:** FOLLOW THE REMOVE PROCEDURE EVEN WHEN A PRE-INSTALLED HARD DISK HAS BEEN REMOVED. – SETUP>SYSTEM>ADMIN>STORAGE>FORMAT, CLICK (←) 'REMOVED'ITEM UNDER THE DISCRETE FORMAT HEADINGS OF A CRRESPONDING HDD TO DISCARD 'HDD' ITEM. WHEN THE REMOVE PROCEDURE IS COMPLETED, DVR WILL AUTO-REBOOT.

2.1.5 Maximum HDD Capacity

- Each model has a different HDD capacity recognition.
- Below table shows the recommended maximum HDD capacity for each model.

Type	S, E(4ch)	A~B	C~D	E (8, 16ch)	F~I
Capacity	3TB	6TB	12TB	6TB	12TB

2.1.6 DVD-RW Installation

- Securely fix DVD-RW by using bracket and screws provided herewith.
- Please do not use any different DVD-RW cables (data cable and power supply cable) other than the ones we provide.
- Otherwise, it may cause damage to the DVD-RW.
- Only one DVD-RW can be used. Mount it at the SATA 5 port (**B, C, D, E (8, 16CH), F, G, H and I Type**).

CAUTION

INSTALL DVD-RW OR/AND HARD DISK AFTER DVR POWER OFF. OTHERWISE, IT MAY CAUSE PERMANENT DAMAGE TO THE HARD DISK. TO TURN OFF DVR, PLEASE CLICK (⏻) SETUP>SYSTEM>SHUTDOWN. ALSO, WAIT FOR 5 SECONDS BEFORE PLUGGING IN POWER SUPPLY AGAIN.

2.2 Connector Wiring

2.2.1 Video-In/Loop Out Connections

S, A, B, C and D Type

- Connect a camera to 'VIDEO IN'.
- If user wishes to link camera input to another device, please connect the camera to 'LOOP OUT'. (**C and I Type**).
- Assure the 'VIDEO IN' and 'LOOP OUT' connections are connected properly, not oppositely.

E, F, G and H Type

- Connect cameras to 'HD-SDI IN' to channel 1 to 16.

I Type

- Connect cameras to 'HD-SDI IN' to channel 1 to 4.
- Connect cameras to 'VIDEO IN' to channel 5 to 16.

NOTE

C and I Type model supports LOOP OUT connection.

2.2.2 HD-SDI Input Signal detection (E, F, G, H and I Type)

- These type of DVRs will automatically detect the input signals from 720P 24, 720P 25, 720P 30, 720P 50, 720P 60, 1080I 50, 1080I 60, 1080P 24, 1080P 25, 1080P 30, 1080P 50, 1080P 60 (Auto Detection) when the system starts.
- 720P and 1080P HD-SDI inputs can be used simultaneously without any restriction on different channel.
- 1080I input cannot be used simultaneously with 720P and/or 1080P.

NOTE

1080i input does not support digital zoom in Live mode.

2.2.3 Monitor Connections (Video Out, VGA, Spot and Multi Spot)

- Video Out (**S, A, B, C, D, G, H and I Type Only**)
 - Use with the CCTV monitor.
 - Connect BNC cable between CCTV monitor and 'VIDEO OUT' of the DVR.
- VGA
 - Use with the computer monitor.
 - Connect VGA cable between computer monitor and 'VGA' of the DVR
- Spot (**S Type Only**)
 - This function supports one Channel Display on Spot Monitor
 - Connect BNC cable between spot monitor and spot port of rear panel.
- Multi Spot (**A, B, C, D and G (4ch) Type Only**)
 - This function supports Multi-channel Display on Spot Monitor
 - Connect BNC cable between spot monitor and multi spot port of rear panel.

CAUTION

BLACK SCREEN WILL APPEAR IF THE MONITOR DOES NOT SUPPORT THE SELECTED RESOLUTION. UNLESS USER PRESS 'OK' DURING BLACK SCREEN, SYSTEM WILL AUTOMATICALLY GO BACK TO THE PREVIOUS RESOLUTION IN 15 SECONDS.

2.2.4 HDMI Connections

- Connect HDMI cable to HD out port of rear panel and HDMI port of HD output device.
- Please click (←) SETUP> DISPLAY> VGA and the following screen will appear.

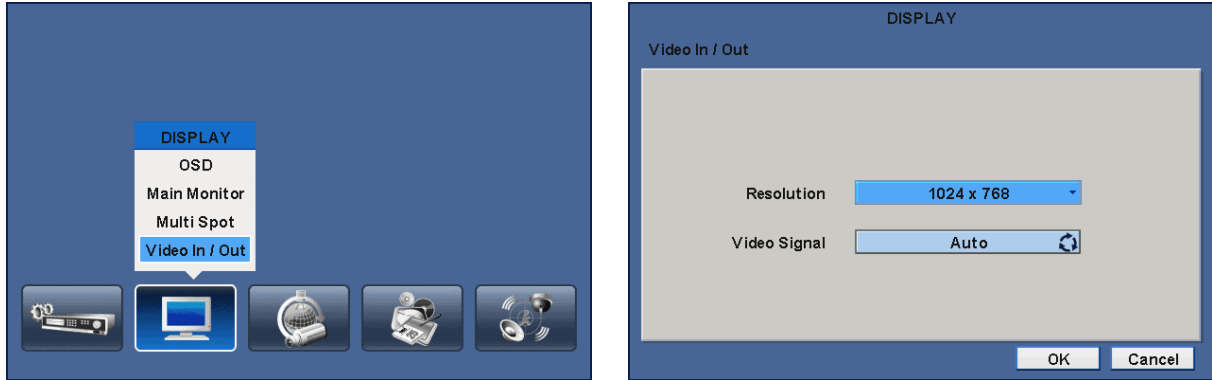

- Click the box below to select resolution.
 - User can select the resolution among '1920x1080 50hz', '1920x1080 60hz', '1280x720 50hz', '1280x720 60hz', and '1024x768'
 - The default setting of DVR is '1280 x 768'.
- Click the box below to select signal format. (S, A, B, C, D, G, H and I Type only)
 - User can select the signal output among 'NTSC', 'PAL' and 'AUTO'.
 - The default setting of DVR is 'AUTO'

CAUTION

HDMI CONNECTION MAY NOT BE COMPATIBLE WITH CERTAIN OUTPUT DEVICE.
VIDEO NOISE MAY OCCUR DEPENDING ON THE TYPE OF HDMI CABLE USED. MAKE SURE TO USE AN HDMI-CERTIFIED CABLE.

CAUTION

BLACK SCREEN WILL APPEAR IF THE MONITOR DOES NOT SUPPORT THE SELECTED RESOLUTION. UNLESS USER PRESS 'OK' DURING BLACK SCREEN, SYSTEM WILL AUTOMATICALLY GO BACK TO THE PREVIOUS RESOLUTION IN 15 SECONDS.

NOTICE

F (4 / 8 CH) Type: Users can select the resolution among '1920x1080 RB', '1920x1080', '1680x1050 RB', '1680x1050', '1280x720', '1024x768'

2.2.5 Audio Connections

- Connect an audio device to 'AUDIO IN' and a speaker system to 'AUDIO OUT'. Please use a speaker system with volume adjustable.

2.2.6 TCP/IP(Ethernet) Connections

- Connect to 'ETHERNET' connector with the LAN cable.
- When connect to Internet, use an ordinary LAN cable (Non-cross cable). However, when connect directly to a PC, please use only 'Crossover cable'.

2.2.7 Alarm Connections(TTL) (S, C, D, E, F, G, H and I Type)

- Connect Alarm Input (Sensor) to 'AI 1~AI 4 (or AI 16)' connectors and connect Sensor Common to 'G' connector.
- Connect Alarm Output (buzzer, siren, etc.) to 'AO 1~AO 4 (or AO 16)' connectors and connect Common to 'G' connector.

2.2.8 Master Alarm (C, D, F, G, H and I type)

- Alarm In sensor will be deactivated if Master Alarm is on.
- Connect Master Alarm In to 'M' connectors.

2.2.9 Alarm Connections(Relay (Dry Contact)) (A~I Type)

- Connect Alarm Output (buzzer, siren, etc.) to 'NO or NC 1~ NO or NC 2' connectors, Power to 'COM' connector and Ground to 'GND' connector.

2.2.10 RS-485/422 Connections

- PTZ Camera connector.
- Please use TX+, TX-, RX+ and RX- terminals.

2.2.11 RS-485 Over Coax Connection (S, A, B, C and I Type)

- PTZ Camera Connector
- Please connect Coax to 'Video In' and select any Protocol in Camera/PTZ setup.

NOTE

PTZ Camera must support RS-485 over Coax function in order to use this feature.

NOTE

When selecting Protocol, user can choose any protocol from the Protocol list other than 'NONE'. If 'NONE' is selected then RS-485 over Coax will not work.

2.2.12 USB Connections

- There are up to four identical USB ports in front and in rear. It is possible to connect a USB memory stick to archive data or a mouse to control the device.

2.2.13 RS-232 Connections

- This port is not in use for users. Do not connect any devices through this port.

CAUTION

WHEN USING THE RS232 SERIAL PORT, USERS MUST REQUEST FOR ASSISTANT TO QUALIFIED TECHNICAL PERSON OR SERVICE REPRESENTATIVE.

2.2.14 Grounding (Earthing)

- Connection of ground wire is highly recommended to protect the DVR from external electric shock, such as lightning, electrical surge.

2.2.15 Factory Reset Switch

- Reset the switch to restore all setup values of menus to factory default settings. It is also possible to use to initialize System Log file.
- The switch is located in a pin hole of the back panel.
- Put the clip pin into the switch hole on the monitor (Live) screen and keep pressing until the switch has clicked.

CAUTION

PRESS FACTORY RESET SWICH ONLY IN LIVE MODE **NEVER** PRESS IN SETUP MODE.

2.2.16 Power Supply connections

- **S Type:** Plug the power supply adapter (**DC 12V, 3A**) which include in this product to 'DC12V' connector and plug another side to power source. Adapter input voltage is a free volt (100 VAC ~ 240 VAC). Please do not use any different power supply adapter because it may cause the DVR to malfunction.
- **A, and B Type:** Plug the power supply adapter (**DC 12V, 5A**) which include in this product to 'DC12V' connector and plug another side to power source. Adapter input voltage is a free volt (100 VAC ~ 240 VAC). Please do not use any different power supply adapter because it may cause the DVR to malfunction.
- **C, D, E, F, G (4ch) H and I Type:** Plug the power supply adapter (**DC 12V, 6.67A**) which include in this product to 'DC12V' connector and plug another side to power source. Adapter input voltage is a free volt (100 VAC ~ 240 VAC). Please do not use any different power supply adapter because it may cause the DVR to malfunction.
- **G (8 / 16ch) Type:** Plug the power source. Products input voltage is a free volt (100 VAC ~ 240 VAC).
- Please do not use any different power supply adapter because it may cause the DVR to malfunction.











2.2.17 Connections Guideline

- **Video out Connector:** If only the monitor is connected to VIDEO OUT connector, please set the impedance switch on the rear side of the monitor to 75 ohms to prevent abnormally bright or collapsed images. If wish to connect another device (e.g., a recorder) to the back of the monitor, please set the impedance switch on the rear side of the monitor to HIGH Z (High Impedance) and set the last device to 75 ohms.
- **Alarm Input Connector:** Do not input any type of voltage to the AI 1~AI 4 (AI 16) connectors.











3. Input Device and Screen Icons









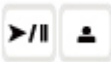

3.1 Key and LEDs

S, A and E (4CH) Type











KEYS		Operating mode	Setup mode
		<ul style="list-style-type: none"> Control Pan/Tilt rotation of up/down/left/right in PTZ mode Rewind, Backward, Play/Pause, Forward, Fast Forward in Playback mode 	<ul style="list-style-type: none"> Menu, Enter / Up/Down/Left/Right on screen cursor control
MENU		<ul style="list-style-type: none"> Enter the Main Menu (Setup mode) 	
DISPLAY		<ul style="list-style-type: none"> Select 1/4/9/16 channel display 	
EVENT		<ul style="list-style-type: none"> System Log display on/off 	
ARCHIVE		<ul style="list-style-type: none"> Copy video data into the external storage device 	
SEARCH		<ul style="list-style-type: none"> Video search mode on/off 	
EMERGENCY		<ul style="list-style-type: none"> Emergency recording on/off 	
Power LED (Red)		<ul style="list-style-type: none"> Light off: DVR off Light on: DVR on 	
HDD LED (Green)		<ul style="list-style-type: none"> Light off: Standby Read/Write Blink : DATA Reading/Writing 	
Network LED (Yellow)		<ul style="list-style-type: none"> Light off: Devices are not connected to DVR through network Light On: Devices are Connected to DVR through network 	

B and E (8, 16CH) Type

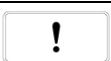
KEYS	PTZ KEY	Operating mode	Setup mode
▲, ▼, ◀, ▶		<ul style="list-style-type: none"> Control Pan/Tilt rotation of up/down/left/right in PTZ mode 	<ul style="list-style-type: none"> Up/Down/Left/Right on screen cursor control
1 ~ 10		<ul style="list-style-type: none"> Camera select keys : (4/8 channel DVR) 	
11 ~ 16		<ul style="list-style-type: none"> Camera select keys : (16 channel DVR) 	
DISPLAY		<ul style="list-style-type: none"> Select 1/4/9/16 channel display 	
SEQUENCE		<ul style="list-style-type: none"> Channel sequence mode on/off (Main Monitor) 	
ARCHIVE		<ul style="list-style-type: none"> Copy video data into the external storage device 	
FREEZE		<ul style="list-style-type: none"> Screen freeze mode on/off 	
ZOOM		<ul style="list-style-type: none"> Zoom-In/Out 	
PIP		<ul style="list-style-type: none"> Picture In Picture display on/off 	
EVENT		<ul style="list-style-type: none"> System Log display on/off 	
EMERGENCY		<ul style="list-style-type: none"> Emergency recording on/off 	

PTZ		<ul style="list-style-type: none"> • Pan/Tilt control mode on/off 	
AUDIO/ESC		<ul style="list-style-type: none"> • Audio on/off (Viewing/Playback) • Select audio channel: Press AUDIO key and then channel key • ESC 	
MENU		<ul style="list-style-type: none"> • Enter the Main Menu (Setup mode) 	
PLAY/PAUSE		<ul style="list-style-type: none"> • Viewing mode: Instant playback (playback the recorded video from the last one minute) • Playback mode: 1X PLAY/PAUSE • Zoom-Out on PTZ mode 	
SEARCH		<ul style="list-style-type: none"> • Video search mode on/off • Zoom-In on PTZ mode 	
REW		<ul style="list-style-type: none"> • Fast backward playback (changes up to x128 with each press) • Focus Near in PTZ mode 	
FF		<ul style="list-style-type: none"> • Fast forward playback (changes up to x128 with each press) • Focus Far in PTZ mode 	
BACKWARD		<ul style="list-style-type: none"> • Frame backward playback • Save Preset in PTZ mode 	
FORWARD		<ul style="list-style-type: none"> • Frame forward playback • Go to Preset in PTZ mode 	
Power LED (Red)		<ul style="list-style-type: none"> • Light off: DVR off • Light on: DVR on 	
HDD LED (Green)		<ul style="list-style-type: none"> • Light off: Standby Read/Write • Blink : DATA Reading/Writing 	
Network LED (Yellow)		<ul style="list-style-type: none"> • Light off: Devices are not connected to DVR through network • Light On: Devices are Connected to DVR through network 	

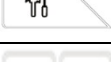
C, D, F, G, H and I Type

KEYS	PTZ KEY	Operating mode	Setup mode
▲, ▼, ◀, ▶		<ul style="list-style-type: none"> • Control Pan/Tilt rotation of up/down/left/right in PTZ mode 	<ul style="list-style-type: none"> • Up/Down/Left/Right on screen cursor control
1 ~ 16		<ul style="list-style-type: none"> • Camera select keys : (4/8/16 channel DVR) 	
DISPLAY		<ul style="list-style-type: none"> • Select 1/4/9/16 channel display 	
SEQUENCE		<ul style="list-style-type: none"> • Channel sequence mode on/off (Main Monitor) 	
ARCHIVE		<ul style="list-style-type: none"> • Copy video data into the external storage device 	
FREEZE		<ul style="list-style-type: none"> • Screen freeze mode on/off 	
EVENT		<ul style="list-style-type: none"> • System Log display on/off 	
EMERGENCY		<ul style="list-style-type: none"> • Emergency recording on/off 	
PTZ		<ul style="list-style-type: none"> • Pan/Tilt control mode on/off 	
AUDIO/ESC		<ul style="list-style-type: none"> • Audio on/off (Viewing/Playback) • Select audio channel: Press AUDIO key and then channel key • ESC 	
MENU		<ul style="list-style-type: none"> • Enter the Main Menu (Setup mode) 	
REW		<ul style="list-style-type: none"> • Fast backward playback (changes up to x128 with each press) • Zoom-Out on PTZ mode 	
BACKWARD		<ul style="list-style-type: none"> • Frame backward playback • Zoom-In on PTZ mode 	

PLAY/PAUSE		<ul style="list-style-type: none"> Viewing mode: Instant playback (playback the recorded video from the last one minute) Playback mode: 1X PLAY/PAUSE Focus Near in PTZ mode 	
FORWARD		<ul style="list-style-type: none"> Frame forward playback Focus Far in PTZ mode 	
FF		<ul style="list-style-type: none"> Fast forward playback (changes up to x128 with each press) Save Preset in PTZ mode 	
SEARCH		<ul style="list-style-type: none"> Video search mode on/off Go to Preset in PTZ mode 	
Power LED (Red)		<ul style="list-style-type: none"> Light off: DVR off Light on: DVR on 	
HDD LED (Green)		<ul style="list-style-type: none"> Light off: Standby Read/Write Blink : DATA Reading/Writing 	
Network LED (Yellow)		<ul style="list-style-type: none"> Light off: Devices are not connected to DVR through network Light On: Devices are Connected to DVR through network 	

3.2 Camera Select Keys for 16 Channel DVR

B and E (8, 16CH) Type



• Below shows how to select camera channel for 4/8/16 channel DVR

- Select Camera No. 1~10: press key and use **1~10** key
- Select Camera No. 10~16: press key and use , **1~6** key

C, E, F, G, H and I Type

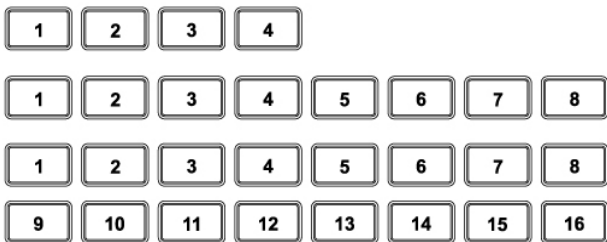

- Below shows how to select camera channel for 4 channel DVR
 - Select Camera No. 1~4
- Below shows how to select camera channel for 8 channel DVR
 - Select Camera No. 1~8
- Below shows how to select camera channel for 16 channel DVR
 - Select Camera No. 1~16

3.3 Front Panel

S, A and E(4CH) Type

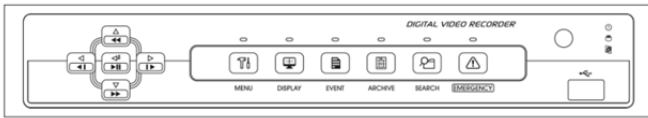

4 / 8 / 16 Channel DVR

B and E(8, 16CH) Type

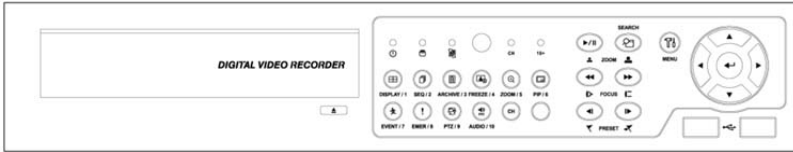

4 Channel DVR

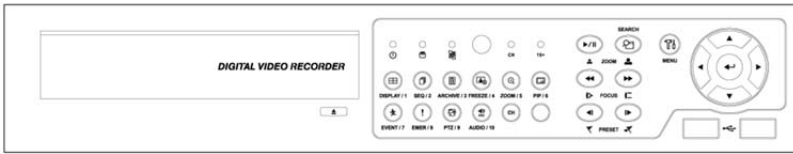

8 Channel DVR

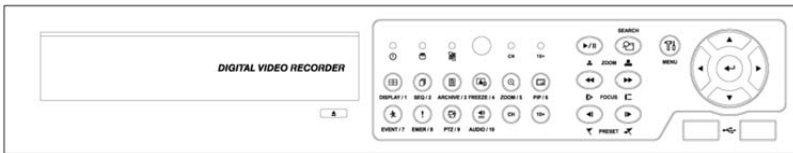

16 Channel DVR

C, D, F, G, H and I Type

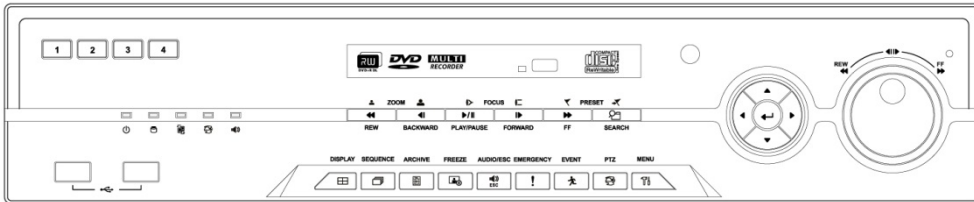

4 Channel DVR

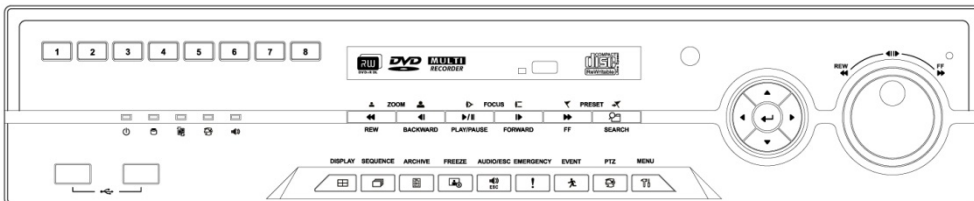

8 Channel DVR

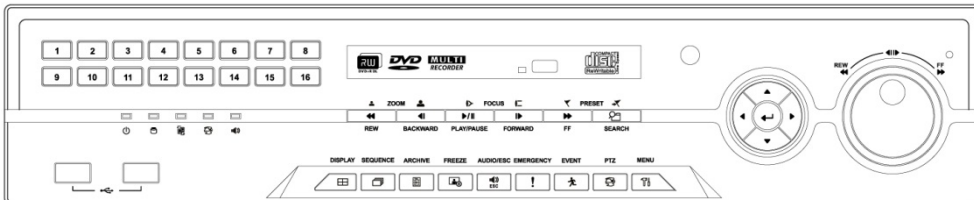

16 Channel DVR

3.4 Using a Remote Controller

- Usage of a remote controller is same as the front panel keys.
- Follow the procedure below when using the remote controller for multi DVRs.
 - ① Check System ID (e.g., between 1 and 255) of the DVR that wish to use.
 - (SETUP>SYSTEM>Information>Status>System ID).
 - ② Holding up the remote controller to face towards the DVR and press the System ID numbers one by one, while pressing ID button on the remote controller. Note that the System ID is a **3-digit number**. Button '10' functions the same as '0'.
 - (e.g.: If System ID is 3, press **10>10>3** buttons in sequence while pressing the ID button)

3.5 Using a Mouse

- Mouse provides an easier access to adjustment. Refer to below for proper use.
- Left mouse button functions the same as **Enter** (↵) key on the front panel of DVR.
- Right mouse button displays the following “Function keys” on screen.
- Click Search menu at “Function Keys” the same as **Search** key on the front panel of DVR. Press the button, then the Search menu will appear on screen.











S, A and E (4CH) Type

Name of Key	Function	Name of Key	Function
Display	Change display mode	Event	Display System Log
Sequence	Display each channel sequentially	Search	Enter Search Mode
Spot	Use spot monitor	Setup	Enter Setup
Freeze	Freeze on live/recorded display	Emergency	Activate Emergency record
PIP	Picture in Picture function	Shutdown	Pre-step before Power off (SETUP>SYSTEM>Shutdown)
PTZ	En/Disable PTZ control	Cancel	Cancel Function key menu

B, C, D, E (8, 16CH), F, G, H and I Type

Name of Key	Function	Name of Key	Function
Display	Same as front key	Event	Same as front key (indicate System Log)
Sequence	Same as front key	Search	One-touch playback (same function with (PLAY/PAUSE))
Spot	Same as front key	Setup	Same as front key
Freeze	Same as front key	Emergency	Same as front key
PIP	Same as front key	Shutdown	Pre-step before Power off (SETUP>SYSTEM>Shutdown)
PTZ	Same as front key	Cancel	Cancel Function key menu

3.6 Screen Icon

Icon	Description	Icon	Description
	Continuous recording mode		In Audio recording
	Event recording mode (Motion, Alarm In)		CMS access indication/ No. of accesses (up to 16)
	In recording		In channel sequencing
	PTZ registration / PTZ mode		Lock
	Setup in HDD Overwrite mode		Setup in HDD No Overwrite mode (HDD Full)
	Setup in HDD No Overwrite mode (recording)		

4. Setup

4.1 Login / Logout

- At the default setting of DVR, user has to input the password to enter the set up menu.
- Please press SETUP key to enter the setup menu and the following screen will appear.

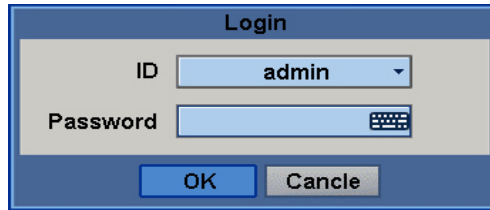

- In order to use all functions and privileges, log in as ID: admin.
- Default Password is "1111".
- At Setup>System>Account, Administrator should set a user rights depending on each user separately in "Login Settings".
- After login successfully, following screen will appear:

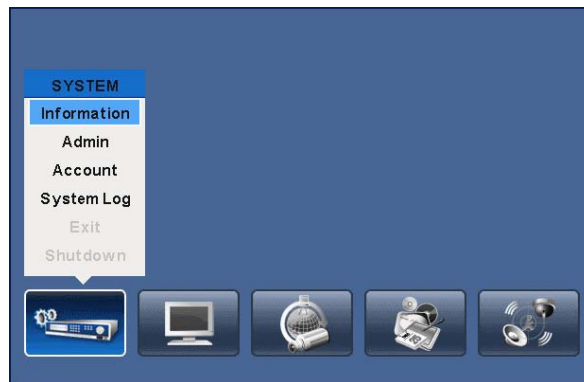

- Recording continues during setup.
- Main menu consists of 5 sub menus.
 - (SYSTEM / DISPLAY / DEVICES / RECORD / LINK)
- There is no factory default in the case of passwords. => Factory default function cannot be applied to passwords.
- To escape from the setup menu, please click (↵) SYSTEM>Exit on the screen. Then, the following dialogue box will appear.

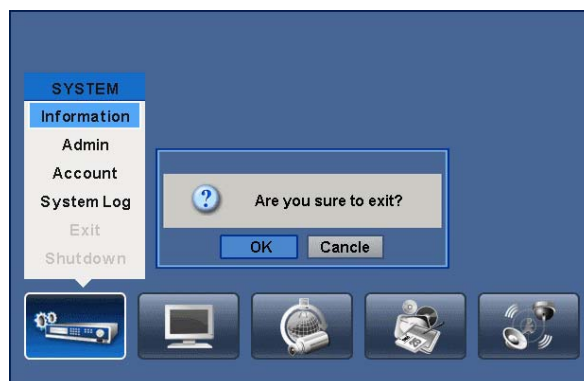

- Please choose 'OK' to log out.
- User may select the Main menu with ◀, ▶ direction keys or mouse click. Please click (↵) the submenu to choose the one under the Main menu.

NOTE

Press AUDIO/ESC in the setup screen. It operates like CANCEL (ESC).
It will not operate in the live or playback mode but only in the setup menu.

4.2 SYSTEM

4.2.1 Information

- Please click (↔) SYSTEM>Information and the following screen will appear.



Status

Site Description

- Decide on a name of DVR.
- Please click (↔) keyboard icon on Site Description frame and the following virtual keyboard will appear.



- Please click (↔) desired letters (characters) on the virtual keyboard to input.

①  Use to erase one character every time.

②  Use to erase the whole sentence.

- Please choose 'OK' to confirm the input and choose 'Cancel' to cancel.

System ID

- Control DVRs by one remote controller by setting DVR IDs.
- Please click (↔) ▲, ▼ direction keys on the right-hand side of the System ID frame to set the ID of DVR. Take any whole number **between 1 and 255**.
- While pressing (+) or (-) button, the System ID value increases or decreases by 10 units.

Language

- Please click (↔) Language frame to choose desired language and press (↔) key again.

Setup

- **Default:** Click (↔) Default frame to restore all setup values of menus to factory default settings. Please note that System Log is not initialized.

NOTE

This has a different function from Factory Reset Switch on the back panel of DVR in that System Log is not initialized.

- **Import:** Copy the Menu setup stored in USB memory stick into DVR. Please plug in the memory stick and then click (↔) Import.
- **Export:** Store the Menu setup of DVR in USB memory stick. Please plug in the memory stick and then click (↔) Export.
- When user is on Default, Import or Export process, a message box will ask the progress and click the confirmation icon, then a message box will show whether its success or failure.

System Log

- **Export:** Store the System Log contents in USB memory stick. Please plug in the memory stick and then click (↔) Export.
- When user is on Default, Import or Export process, a message box will ask to proceed and click the confirmation icon, then a message box will show whether its success or fail.

Version

- When user complete Status data input, please click (↔) Version and the following screen will appear.

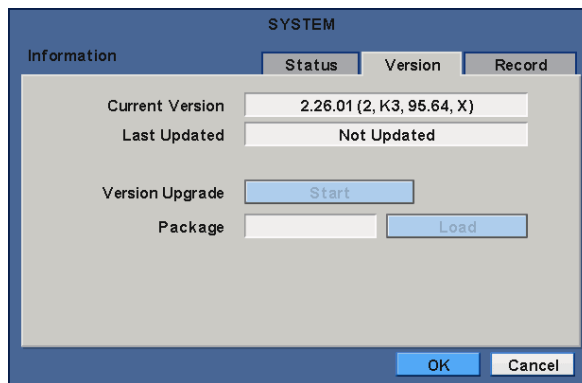

Version Upgrade

- User may upgrade DVR software.
- Please follow the Upgrade procedure below.
 - ① Plug USB memory stick having upgrade file into DVR.
 - ② Click (↔) Load frame. Then, software version stored in the USB will appear on the left-hand side.
 - ③ Click (↔) Start frame to start the upgrade.
 - ④ When the upgrade is completed, a dialogue box pops up. Please choose 'OK' and DVR will auto-reboot.

NOTE

Upgrade file must be placed without folder. Otherwise SYSTEM will not be able to recognize the file.

CAUTION

DO NOT UPGRADE UNTIL A HARD DISK DRIVE IS INSTALLED. MAKE SURE TO UPGRADE WHEN HDD IS IN PROPER OPERATION.

CAUTION

PLUGGING OUT USB DEVICE OR FORCED POWER-OFF DURING VERSION UPGRADE MAY CAUSE PERMANENT DAMAGE.

CAUTION

REMOTE UPGRADING WILL CAUSE SYSTEM TO CHANGE ALL THE SETTINGS TO DEFAULT EXCEPT NETWORK SETTING.

Record

- When user completes Version input, please click (↔) Record. Then, the following screen will appear.

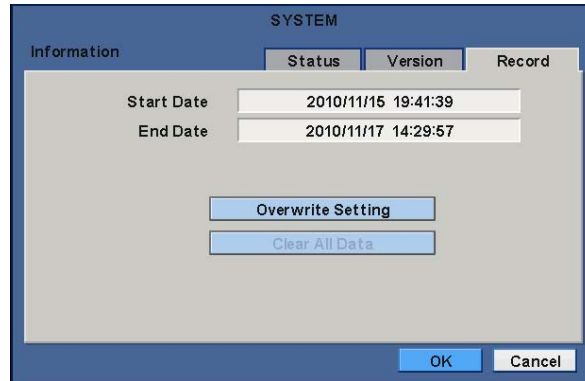



- The screen shows start time and end time of recorded data.

Overwrite Setting

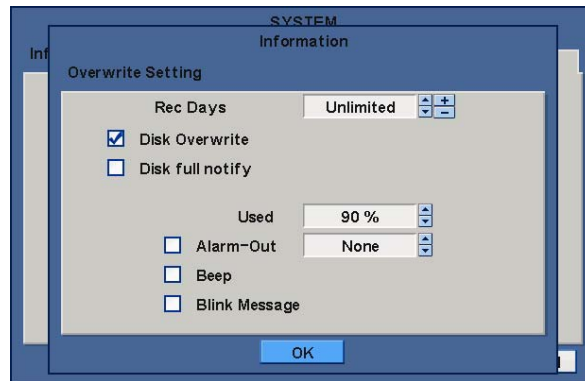
- Click (↔) Overwrite Setting button and the following screen will appear.



- User shall designate the total recording days from 1 day to 30 days and unlimited.
- User may set for beeping or notifying messages that notify the used percentage of disk.
- Check Disk Overwrite and user may activate the overwrite function.
 - This function makes restart the recording from the beginning when the HDD is full. The previous recorded data will be erased from the first one. Following icon will display in bottom of live mode. .
- ① Uncheck () Disk Overwrite, recording will stop automatically when the HDD is full.
- ② At no Overwrite mode,  icon will appear when HDD capacity is full that indicates the recording has stopped and,  icon will appear while the recording is going on.
- ③ If user changes this setting, the warning message will appear. Then click (↔) “confirmation” button and user may change the setting.
- If user checks () Disk full notify item, the warning message will appear as the used amount of disk.
 - ① **Used**
 - User may set the certain value of HDD usage for notification. It will notify at that point. The values are from 50 ~ 100%.
 - ② **Alarm-Out**
 - The Alarm-out will happen at the used amount of HDD which is specified at Used.
 - ③ **Beep**
 - Check () , the warning sound will happen at the used amount of HDD which is specified at Used.
 - ④ **Blink Message**
 - Check () , the warning message “Disk Used (xx%)!” will appear on the OSD.

CAUTION

IF USER USES "Rec Days" FUNCTION, DVR WILL STORE ONLY THE DAYS THAT SPECIFIED BY USER. PLEASE BEWARE OF DATA LOSS DUE TO "Rec Days" FUNCTION.

NOTE

Notify setting does not affect saving the recorded data. It only gives notification and keep recording until hard disk is full.

NOTE

For more specific setting about Alarm-out, use Setup>DEVICES>Alarm Out.

Clear All Data

- Use to delete or purge all normal recorded data from database. Please follow the procedure below.
 - ① Click (←) Clear All Data frame.
 - ② When a dialogue box asking "Remove All Data?" shows, choose 'OK'.
 - ③ Then, Progress window will appear and the process starts.
 - ④ When all data are deleted, a dialogue box asking "Are you sure to remove log?" will pop up.
 - ⑤ Choose 'OK' to delete all the recorded data as well as System Log.
- When user finished all the necessary inputs to SYSTEM menu, please click (←) 'OK' on the bottom to go back to SETUP screen.

NOTE

This might take a while to completely delete all data, and DVR will reboot after the data is cleared.

CAUTION

DELETED DATA CANNOT BE RESTORED.

4.2.2 Admin

- Please click (←) SYSTEM>Admin and the following screen will appear.

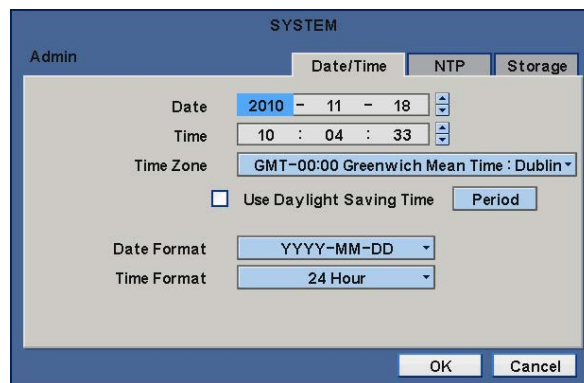
**Date / Time****Date**

- This menu will allow user to adjust the settings.
- Please follow the procedure below for time adjustment.
 - ① Click (←) items (Y, M, D) to change. A designated item will be highlighted in a box (Y: Year, M: Month and D: Date).
 - ② Adjust the number by clicking (←) ▲, ▼ buttons on the right-hand side.
 - ③ Repeat the same procedure to change Y, M and D.

Time

- This menu will allow user to adjust the current time. The adjustment procedure is same as of Date.

CAUTION

IF ADJUSTED DATE/TIME IS PRIOR TO RECORDED DATA, DATA AFTER NEW DATE/TIME MAY BE ERASED.

CAUTION

ANY CHANGE IN DATE/TIME IS IMMEDIATELY APPLIED ON VIEWING SCREEN (LIVE), BUT THE DATE/TIME WHEN THE RECORDING WAS DONE IS NOT CHANGED. MAKE SURE TO REBOOT DVR AFTER CHANGING THE DATE/TIME. DO NOT FORGET TO EXECUTE SHUTDOWN (SYSTEM>Shutdown) BEFORE REBOOT.

Time Zone

- Please click (←) Time Zone frame to see the list of nations and choose one.
- Click (←) a check box next to Use Daylight Saving Time. When user dwells in a region of DST area, please check it (i.e.).
- If DST is observed, please click (←) Period and the following screen will appear.

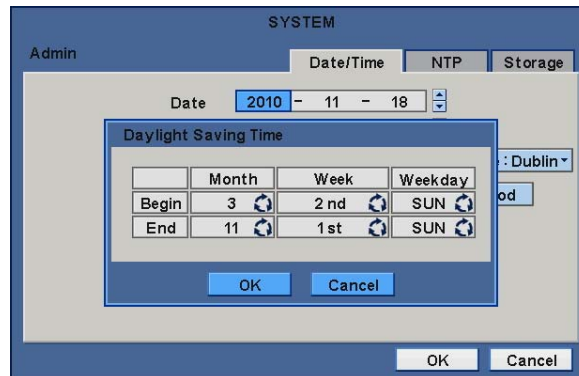

- Adjust the dates of beginning (Begin) and end (End) of DST by 'Month/Week/Weekday'.
- Click (←) the numbers in 'Month/Week/Weekday' for adjustment.
- Choose 'OK' to confirm the setting.

Date Format

- Set date indication format. Please click (←) Date Format frame to select a format from the list.

Time Format

- Set time indication format. Please click (←) Time Format frame to select a format from the list.

NTP

- When user complete Date/Time input, please click (←) NTP and the following screen will appear.

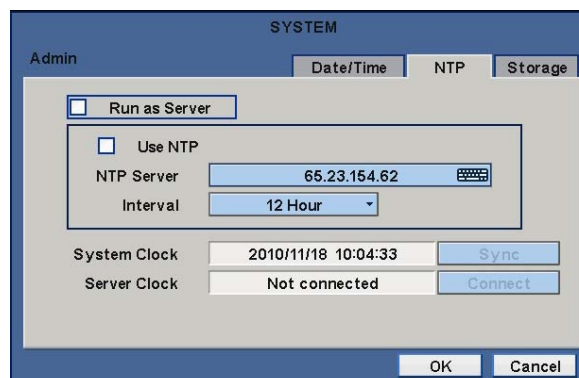

- This menu is for accurate setting of time of day clock in DVR.
- User may check only one of Run as Server and Use NTP.
 - **Run as Server:** NTP cannot be used in a non-networked environment (Intranet environment). In this case, DVR with Run as Server functions as Time Server.
 - **Use NTP:** Connect to Internet to synchronize DVR clock with Network Time Server's clock.
- When user completes NTP input, please click (←) to save the setup.

NTP Server

- Click (←) keyboard icon in NTP Server frame and the virtual keyboard will appear. Input IP address of NTP server.

NOTE

“Use NTP” function connected to the Time zone, user should set the Time zone correctly to operate the NTP function properly.

NOTE

Currently used NTP is administered by pool.ntp.org and its IP address is 65.23.154.62. However, users are allowed to use IP address of any NTP site.

Interval

- Set clock-update-interval from NTP Server. Normally, user can adjust 1 hour up to 24 hours.

System Clock

- Display DVR clock.

Server Clock

- Display NTP Server's clock if Internet is connected to Server Clock. If not displaying, please click (↔) Connect button.
- When Server Clock is displayed, please click (↔) Sync button to synchronize NTP Server's clock with DVR clock.
- Choose 'OK' to confirm the clock synchronization.

Storage

- When users click the storage tab, following screen will appear.
- Set S.M.A.R.T. (Self-Monitoring Analysis and Reporting Technology) function for HDD format and auto-display of HDD information. DVD-RW is not shown here.

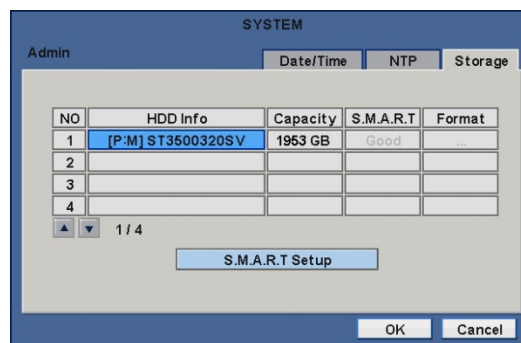

- Clicking Up and Down button for checking up the status of HDD and DVD-RW devices.
- Using E-SATA port will allow users to connect up to maximum 8 HDD +1 DVD-RW. (**C, F, G, H and I Type**)
- When user installs full storage device and DVD-RW including two e-SATA storage, then following procedures will be listed as below:
 - 1. Internal SATA 1~4 Ports
 - 2. External SATA 1
 - 3. DVD-RW

Format

- User must format when:
 - install new HDD
 - add another HDD
 - replace HDD
 - move HDD (change installation port)
 - remove HDD
- Click (↔) Add/Remove frame in Format column and choose 'OK' on the dialogue box to start formatting.
- Following format, DVR will auto-reboot. If there are more than 2 HDDs, please formats each of HDDs. DVR will auto-reboot when all the HDDs are formatted.
- If the format changes to '---'after reboot, it means formatting has been properly done.

CAUTION

EXECUTE REMOVE PROCEDURE EVEN WHEN USER REMOVE PREVIOUSLY INSTALLED HDD. THE REMOVE PROCEDURE IS THE SAME AS THE FORMAT PROCEDURE DESCRIBED ABOVE.

S.M.A.R.T

- Click the frame on S.M.A.R.T column and temperature and HDD damage will show.

S.M.A.R.T Setup

- Please click (←) S.M.A.R.T Setup and the following screen will appear.

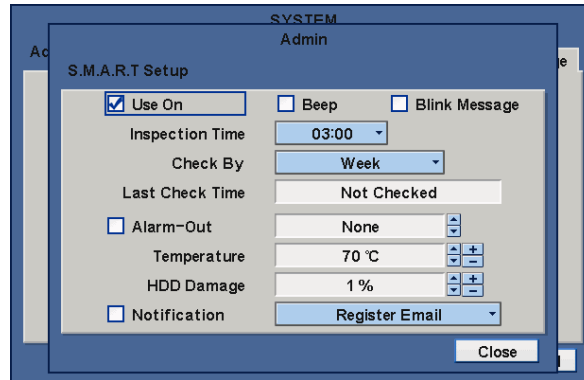

- Check the square box next to Use On. Through S.M.A.R.T function, make alarm message, indicating HDD damage, will show.
- Check Beep; it will give the alarm sound, indicating HDD damage, as the SMART setup.
- Check Blink Message, the alarm message will blink on the OSD, as the SMART setup.
- If "Use on" box is unchecked, Beep, Blink Message will be unchecked automatically. Only when "Use on" is checked , user can set Beep, Blink Message function.
- Click (←) Inspection Time frame to set inspection time.
- Click Check by frame to select inspection interval.
- Last Check Time: show the time of the last inspection.
- Check Alarm out: user can set the alarm out, when S.M.A.R.T function detects abnormal symptoms from HDD.
- Duration of alarm out operating time can adjust on DEVICES>Alarm Out setup section (please refer 4.4.5).
- Clicking (←) ▲, ▼ direction buttons on the right-hand of alarm-out frame to select the device for alarm out.
- Click (←) ▲, ▼ direction buttons on the right-hand side of Temperature frame to adjust to maximum temperature for the HDD used in DVR. In general, it is 55°C.
 - While pressing (+) or (-) button on the rightmost side of Temperature, a target value increases or decreases by 10 units.
- Check Notification: user can send the email notification to registered email address, when S.M.A.R.T function detects abnormal symptoms from HDD.
- Choose 'OK' to confirm the setting.

4.2.3 Account

- Please click (←) SYSTEM>Account and the following screen will appear.

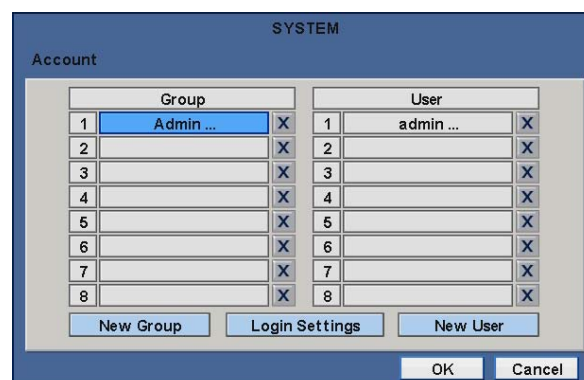

New Group

- Please click (←) New Group and the following screen will appear.

SYSTEM
SYSTEM

Account

Group Name

Setup Archiving
 Search Shutdown
 Network

OK Cancel

- Click (←) keyboard icon on the right-hand side of Group Name frame. Then, the virtual keyboard will show. Please click (←) desired characters (up to 8 characteristics) on the virtual keyboard.
- Do provisioning for Group Name by selectively checking some of the following items (Setup, Search, Network, Archiving and Shut Down).
- Choose 'OK' to confirm the setting.

Login Setting

- Please click (←) Login Settings and the following screen will appear.

SYSTEM
SYSTEM

Account

Login required for followings

Setup Archiving
 Search Shutdown
 Network

OK Cancel

- Selectively enable password protection for important operations (Setup, Search, Network, Archiving and Shut Down).
- Please check the operations that wish to enable password protection.
- Choose 'OK' to confirm the setting.

CAUTION

USER WILL NOT BE ASKED TO ENTER THE PASSWORD FOR OPERATION(S) WHEN PASSWORD PROTECTION IS NOT ACTIVATED.

New User

- Please click (←) New User and the following screen will appear.

SYSTEM
SYSTEM

Account

User Name

Password

Confirm

Select Group

OK Cancel

- Click (↵) the keyboard icon on the right-hand side of User Name frame and the virtual keyboard will appear. Click desired characteristics (up to 8 characteristics) on the virtual keyboard.
- Input Password and Confirm.
- Choose 'OK' to confirm the setting. Then, lists of Group and User will show as follows.

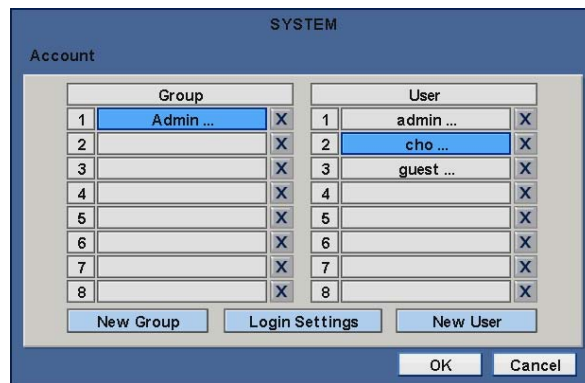

- Click (↵) ☒ to delete the set Group or User.
- User may create up to 8 Groups and 8 Users per Group.
- Choose 'OK' to confirm the setting.

Password Resetting

- Click ID on User column. The following screen will appear.



- This is a screen for password resetting.
- Input password by clicking the keyboard icon on the right-hand side of the frame.

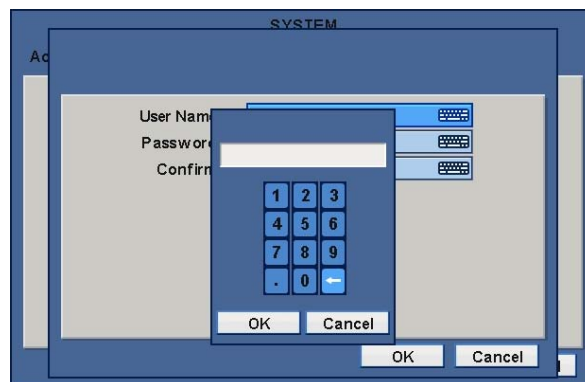

- Use  key if wish to erase password on keyboard.

4.2.4 System Log

- Please click (←) SYSTEM>System Log and the following screen will appear.

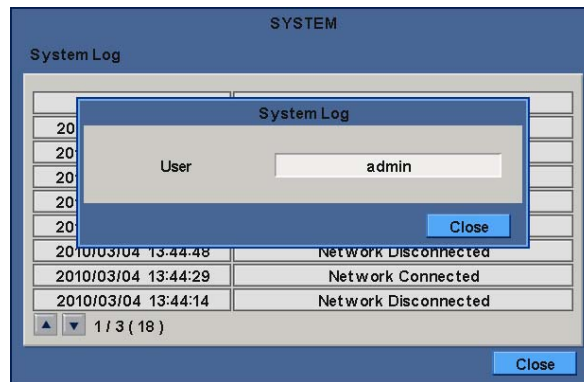

- System Log displays diverse events as below events by specifying the user account that actually has accessed the DVR.
 - Setup (Menu) Enter/Exit
 - Playback Mode Enter/Exit
 - Network Access Enter/Exit
 - Archive Success/Fail
 - System Start/shut down
 - S.M.A.R.T. Check
 - NTP Sync/ Server Success/Fail
 - Send E-mail Success/Fail
 - HDD Format Success/Fail
 - Data clear Success/Fail
 - USB Upgrade Success/Fail
 - DVR Setup Change by Remote
 - Before/After Time Adjust
 - Video loss
- System Log removal procedure is as follows:
 - Execute Clear All Data in SYSTEM>Information>Record and choose 'OK' on the popup dialogue box. Please note that all normal recorded video data are deleted from database.
 - Press Factory Reset Switch on the back panel. Please note that the entire menu setup is also defaulted.

4.2.5 Exit

- Please click (←) SYSTEM>Exit and choose 'OK' on the popup dialogue box to exit from the setting.

CAUTION

ANY CHANGES MADE IN SETUP WILL BE APPLIED AFTER EXIT.

4.2.6 Shutdown

- Shutdown is a function to help user safely turn the DVR off. Please use the proper shut down procedure to avoid damaging to our DVR system. Do not remove the power during shut down.
- Click (←) SYSTEM>Shutdown and then choose 'OK' on the dialogue box to confirm.
- When user select Shutdown menu, the OSD menu on the screen disappears.
- Reboot the DVR after Shutdown. Turn off the DVR and wait for 5 seconds before restart.

CAUTION

DO NOT TURN DVR OFF WITHOUT USING THE PROPER SHUT DOWN PROCEDURE. OTHERWISE, IT MAY CAUSE DAMAGE TO DVR. ALWAYS REMOVE THE POWER AFTER SHUT DOWN.

4.3 DISPLAY

- Please click (←) DISPLAY and the following screen will appear.

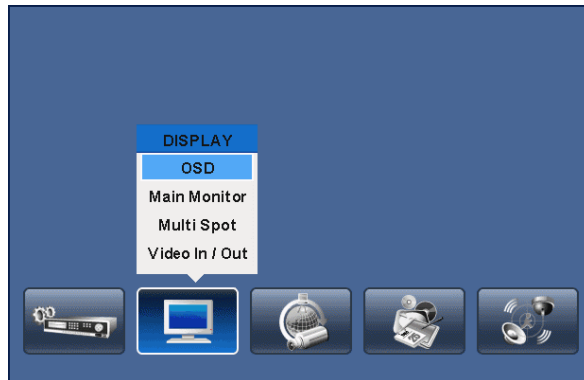

4.3.1 OSD

- Please click (←) DISPLAY>OSD and the following screen will appear.

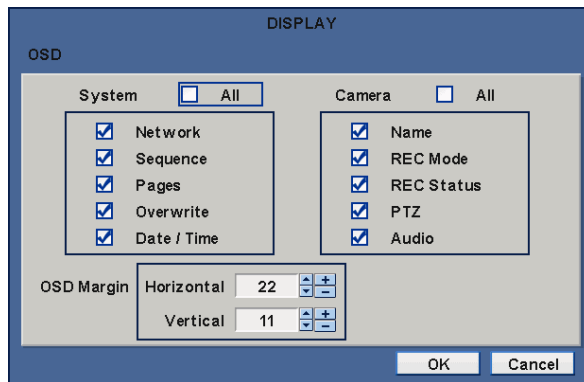

- The OSD menu will allow user to configure full features (i.e., on/off every letter and icon) displayed on the screen.
- Letters and icons are divided under System and Camera categories. If click (←) 'All', all items are on/off at once.

OSD Margin

- The OSD Margin menu will allow user to adjust the position of OSD (letters) on the monitor. Use it when some of letters are dropped out and invisible on the monitor.
- Adjust Horizontal to change margin between both ends of the monitor on horizontal side and OSD. Margin range is between **0 and 50**, with a larger number representing greater margin.
- Adjust Vertical to change margin between both ends of the monitor on vert 130.
- Vertical side and OSD Margin range is between **0 and 50**, with a larger number representing greater margin.
- While pressing (+) or (-) button, a target value increases or decreases by 10 units.

4.3.2 Main Monitor

- Please click (←) DISPLAY>Main Monitor and the following screen will appear.

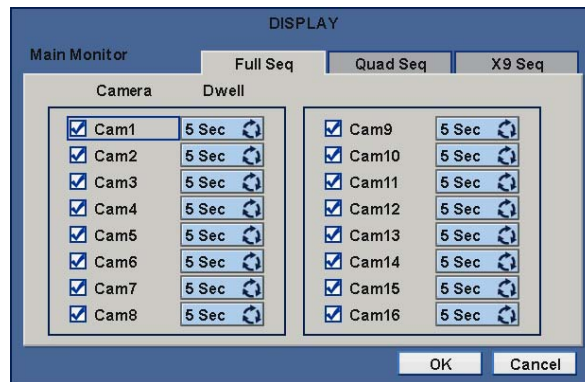

- The Main Monitor menu will allow user to adjust channel sequencing interval of Main monitor.

Full Seq

- Adjust interval for 'Full screen sequencing'.
- Check check box next to the camera that wish to include in sequencing. Any camera with unchecked check box will be excluded from channel sequencing.
- Adjust the rotation interval of camera by clicking Dwell column. The rotation interval changes to **3>5>10>15>30>60 seconds** by each press.

Quad Seq

- Use only with 8 / 16 channel DVRs.
- Adjust interval for 'X4 Split Screen sequencing'.
- Check check box next to the camera that wish to include in sequencing. Any camera with unchecked check box will be excluded from channel sequencing.
- Adjust the rotation interval of camera by clicking Dwell column. The rotation interval changes to **3>5>10>15>30>60 seconds** by each press.
- '4 Split Screen sequencing' is disabled in the following modes.
 - **8 channel DVR:** 3x3 Mode
 - **16 channel DVR:** 4x4 Mode

X9 Seq

- Use only with 16 channel DVR.
- Adjust interval for 'X9 Split Screen sequencing'.
- Check check box next to the camera that wish to include in sequencing. Any camera with unchecked check box will be excluded from channel sequencing.
- Adjust the rotation interval of camera by clicking Dwell column. The rotation interval changes to **3>5>10>15>30>60 seconds** by each press.
- '9 Split Screen sequencing' is disabled in 4X4 Mode.

4.3.3 Multi Spot

- This connection supports multi-channel display (1/4/9/16) on spot monitor depending on its channels(4/8/16).
- Click [MS] button on the menu bar to select the Multi Spot.
- Click [1/4/9/16] button to select the multi-channel split display mode.

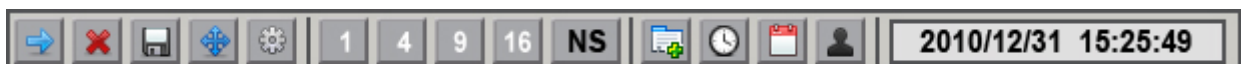

- Please click (←) DISPLAY>Multi Spot and the following screen will appear.

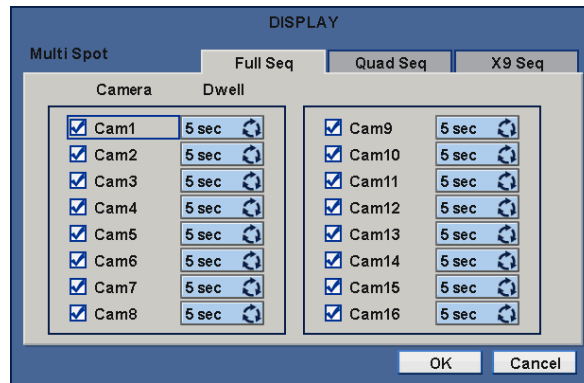

- The Multi Spot menu will allow user to adjust channel sequencing interval of **Spot** monitor.

Full Seq

- Adjust interval for 'Full screen sequencing'.
- Check check box next to the camera that wish to include in sequencing. Any camera with unchecked check box will be excluded from channel sequencing.
- Adjust the rotation interval of camera by clicking Dwell column. The rotation interval changes to **3>5>10>15>30>60 seconds** by each press.

Quad Seq

- Use only with 8 / 16 channel DVRs.
- Adjust interval for 'X4 Split Screen sequencing'.
- Check check box next to the camera that wish to include in sequencing. Any camera with unchecked check box will be excluded from channel sequencing.
- Adjust the rotation interval of camera by clicking Dwell column. The rotation interval changes to **3>5>10>15>30>60 seconds** by each press.
- '4 Split Screen sequencing' is disabled in the following modes.
 - **8 channel DVR:** 3x3 Mode
 - **16 channel DVR:** 4x4 Mode

X9 Seq

- Use only with 16 channel DVR.
- Adjust interval for 'X9 Split Screen sequencing'.
- Check check box next to the camera that wish to include in sequencing. Any camera with unchecked check box will be excluded from channel sequencing.
- Adjust the rotation interval of camera by clicking Dwell column. The rotation interval changes to **3>5>10>15>30>60 seconds** by each press.
- '9 Split Screen sequencing' is disabled in 4X4 Mode.

4.3.4 Video In / Out

- Users are able to set its video output resolution from 1024 x 768 to 1920 x 1080

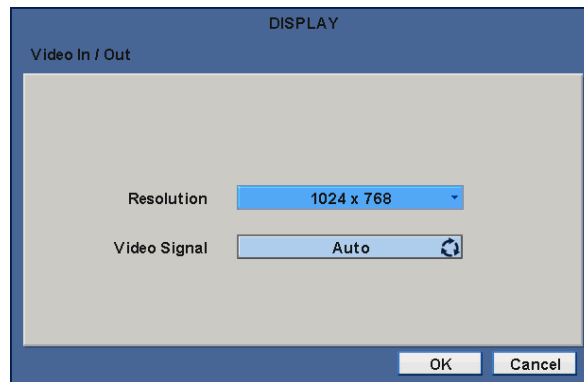

- DVR displays and records differently with previous NTSC or PAL methods.
- Analog Output will help users to select its video output between NTSC and PAL. (S, A, B, C, D, G, H and I Type only)

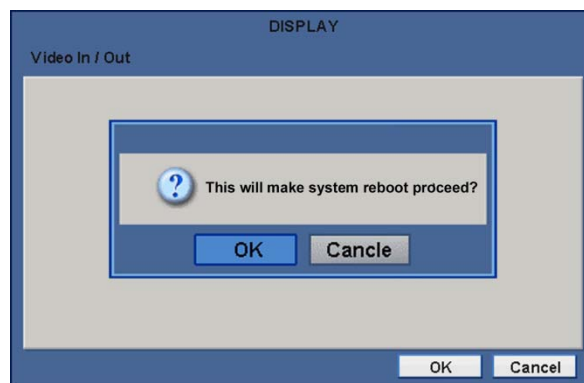

- Once it has changed, it will ask to reboot for the new recognition of video out method.
- The default value is 'AUTO'.

4.4 DEVICES

- Please click (←) DEVICES and the following screen will appear.



4.4.1 Network

- Please click (↔) DEVICES>Network and the following screen will show.

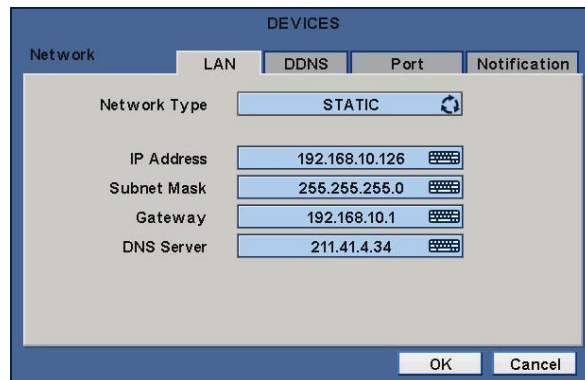

LAN

Network Type

- Please click (↔) Network Type. When you click (↔) the button, it changes alternately to Static (fixed IP) and DHCP (floating IP).
- In Static, user must manually set the static IP address for use.
 - Set IP Address, Subnet Mask and Gateway. Please ask your network administrator for more details.
 - To input address, please click (↔) and execute the keyboard icon on the right-hand side of each frame.

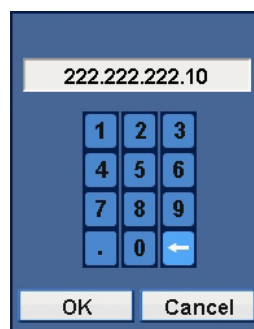

- In DHCP, IP Address, Subnet Mask, Gateway and DNS Server will have input automatically.

DNS Server

- When user set Network Type to DHCP, DNS server will be inputted automatically.
- When user set Network Type to Static, please click (↔) the keyboard icon on the right-hand side of DNS Server frame and manually input the address.

CAUTION

NOTE THAT DNS SERVER ADDRESS IS IP ADDRESS OF YOUR COMMUNICATIONS COMPANY NAME SERVER PROVIDING INTERNET SERVICE. IT IS NOT THE IP ADDRESS OF DDNS SERVICE SITE.

DDNS

- Please click (←) DDNS and the following screen will appear.

DEVICES

Network LAN DDNS Port Notification

Dvrdomain.com 3rd party

DDNS Server dvrdomain.com

Port 95

MAC Address 00:19:9c:05:ca:04

Domain Name

ID

Password

Get Domain Name

OK Cancel

- 'Floating IP system', although being predominantly used over Internet, is very inconvenient for users because its address varies every time when user access. The best alternative is DDNS (Dynamic Domain Naming System) which uses name (domain name) instead of IP address (numbers). DDNS automatically recognizes ever changing, floating IP addresses, so it will allow easy Internet access.
- Dvrdomain.com
 - Check a checkbox of Dvrdomain.com to use Dvrdomain.com Server.
 - As for DDNS Server, Dvrdomain.com will be showing as default.
 - As for Port, 95 will be shown as default. If '95' is unable, please consult with a product distributor.

DEVICES

Network LAN DDNS Port Notification

Dvrdomain.com 3rd party

DDNS Server dvrdomain.com

Port 95

MAC Address 00:19:9c:04:4f:c9

Domain Name ddns04-4f-c9.dvrdomain.com

ID

Password

Get Domain Name

OK Cancel

- When user press Get Domain Name button, Domain Name and MAC Address value will automatically display after 10 seconds.
- Choose 'OK' to confirm the setting.
- 3rd Party
 - Check a checkbox of 3rd Party to use dyndns.org or no-ip.com Server.
 - As for DDNS Server, dyndns.org will be showing as default. No-ip.com can be selected by clicking the arrow.

DEVICES

Network LAN DDNS Port Notification

Dvrdomain.com 3rd party

DDNS Server dvrdomain.com

Port 95

MAC Address 00:19:9c:04:4f:c9

Domain Name

ID

Password

Run ddns service

OK Cancel

- As for Domain Name, user has to input the Domain Name given from the selected DDNS Server.
- As for ID and Pass word, use the user ID and Password to log in to the selected DDNS Server.
- Click “Run ddns service” to start mapping from DVR to DDNS Server.
- Choose ‘OK’ to confirm the setting.

CAUTION

For the security reason, please do not use default password to admin account.

NOTE

User must join ‘dyndns.org’ or ‘no-ip.com’ prior to using it as DDNS server. Please check corresponding website for more information.

Port

- Please click (↔) Port and the following screen will appear.

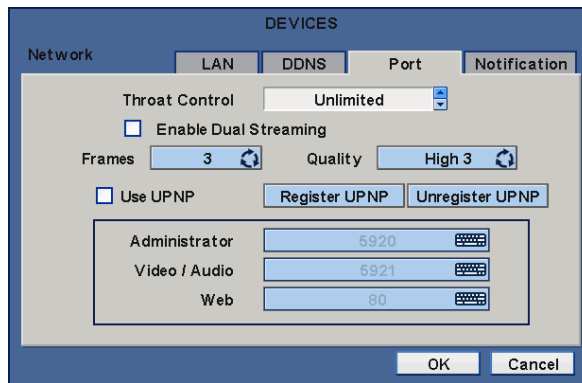

- Network Throat Control is for setting an average transfer speed.
- Please choose the suitable speed according to the users’ network environment.
- If users want to use dual streaming, please click on the check box beside the “Enable Dual Streaming”. If not, please uncheck the check box.
- There are total of 14 different network throat controls users may choose. (bps: bit per second) 26 kbps, 128 kbps, 256 kbps, 512 kbps, 1 Mbps, 2 Mbps, 4 Mbps, 8 Mbps, 10 Mbps, 20 Mbps, 40 Mbps, 80 Mbps, 100 Mbps, Unlimited(default).
 - Ethernet support Max. 1000Mbps.
- Network video transmission speed and quality can be configured by pressing “Frames” and “Quality” buttons as follows.
 - Frames : 1, 2, 3, 4, 5, 7, 15, 30 frames for NTSC (1, 2, 3, 4, 5, 6, 12.5, 25 frames for PAL)
 - Quality : Std. 1, Std. 2, Std. 3, Std. 4 (standard), High 1, High 2, High 3, Super 1, Super 2, Super 3
- The Port Number Setup menu will allow users to set Administrator and Port Number for Video/Audio and Web Port.
- The Port Number Setup menu has two selections of “Register UPNP” or “Unregister UPNP”.
- Click (↔) “Register UPNP” for automatic port forwarding.
- Click (↔) “Unregister UPNP” to do port forwarding manually.
- For Port Number Setup, please get an approval of the network administrator in connection with CMS program.
- Port number
 - **Administrator:** 5000~65535
 - **Video / Audio:** 5000~65535
 - **Web:** 1~65535
- Choose ‘OK’ to confirm the setting.

NOTE

If users check the “Enable Dual Streaming” and click “OK” button, DVR will automatically reboot.

CAUTION

IT IS NOT POSSIBLE TO CHANGE PORT NUMBER DURING CMS ACCESS TO DVR.

CAUTION

CHANGES MADE IN SETUP WILL BE APPLIED AFTER EXITING THE MENU.

CAUTION

PLEASE CHECK THE ROUTER FOR UPNP SUPPORTABILITY BEFORE START USING THE UPNP FEATURE.

CAUTION

ONCE PORT NUMBERS ARE CHANGED, IT MUST BE CHANGED THE PORT NUMBERS OF CMS (Central Monitoring Station) PROGRAM AS WELL.

Notification

- Please click (↵) Notification and the following screen will appear.

The screenshot shows the 'DEVICES' configuration window with the 'Notification' tab selected. It includes an 'Add E-Mail' button, a table with 5 rows for 'No' and 'E-Mail Address', and fields for 'SMTP Server', 'Sender ID', 'Password', and 'SMTP Port'. A checkbox 'Use dvrdomain.com' is checked. 'Attachment' is set to 'None' and 'Duration' is set to '1 Sec'. 'OK' and 'Cancel' buttons are at the bottom.

- The Notification menu allows users to send the message of the Event occurred in DVR via E-Mail.
- Click (↵) the keyboard icon on the right-hand side of Add E-Mail frame and the virtual keyboard will appear. Please register E-Mail address. E-Mail address should contain @.
- Click (↵) the keyboard icon on the right-hand side of SMTP Server frame and the virtual keyboard will appear. Please register the SMTP Server. SMTP server can be set up by the users to have own SMTP server on their site.
- Click (↵) the keyboard icon on the right-hand side of Sender ID frame and the virtual keyboard will appear. Please register an ID to the sender mail server (e.g., tony123).
- If users want to use dvrdomain.com which is offered by manufacturer instead of own SMTP server, please click on the check box (use dvrdomain.com).
- Default number of SMPT port is 25. Please note that some particular areas have restriction on the default port. If so, port number 2525 and 587 can be replaceable.
- When an event occurs, users can send an email to a designated mail address by clicking attach button and selecting data to be transmitted. Users may select one of JPEG, VIDEO CLIP and None. In case of transmitting VIDEO CLIP data, set the duration of time for recoded data in duration menu. (e.g., 5 sec, 10 sec).

CAUTION

ACCORDING TO THE VARIOUS LOCAL CONDITIONS; SSL EMAIL SERVERS MAY NOT WORK CORRECTLY WITH THIS FUNCTION. IF SO PLEASE INACTIVATE THE SSL FEATURE IN THE SERVER SETUP. NOTE THAT SOME SERVER MAY NOT HAVE THIS INACTIVATE FEATURE

CAUTION

DEPENDING ON THE VARIOUS LOCAL CONDITIONS, SOME E-MAIL SERVERES MAY NOT WORK PROPERLY WITH THIS FUNCTION.

4.4.2 Camera / PTZ

- Please click (←) DEVICES>Camera/PTZ and the following screen will appear.
- Click (←) the keyboard icon on the right-hand side of each frame on Title column and the virtual keyboard will appear. Then, register titles of cameras.
- If a check box is checked on No column, a video of the corresponding camera is recorded and displayed on the monitor. However, if user does not check the checkbox, both recording and monitor display stop. Then, DVR picture, instead of a recorded video, will be displayed on the monitor.

CAUTION

WHEN USER EXCLUDES A CORRESPONDING CAMERA VIDEO FROM RECORDING AND MONITOR DISPLAY (CHECK A CHECK BOX) , MAKE SURE CHANNELS OF LARGE NUMBERS ARE EXCLUDED FIRST.

- If a check box is checked on Covert column, a video is recorded but is not displayed on the monitor.
- Click (←) each frame on PTZ column to select PTZ protocols connected to a corresponding camera.

NOTE

When using RS-485 over Coax, user can select any protocol from the Protocol list other than 'NONE'. If 'NONE' is selected then RS-485 over Coax will not work.

- Click (←) each frame on Set to set PTZ Settings connected to a corresponding camera.

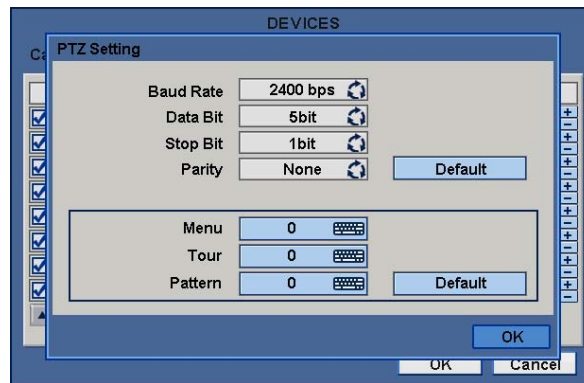

- If users click (**Default**), proper number of selected PTZ will appear automatically. Please choose 'OK' to confirm the setting.
- Menu, Tour and Pattern help user to use OSD function of PTZ camera.
 - PTZ camera itself supports OSD menu, use the setup value to more easily enter and use the OSD menu even in DVR.
 - If OSD enter command is 95 + PSET for example, designate 95 for Menu item,
 - If shortcut key to use Tour function is 71 ~79 + PSET, designate 70 for Tour item and
 - If shortcut key to use Pattern function is 81 ~ 89 + PSET, designate 80 for Pattern item.
 - The setting information herein is used for PAN/TILT control in 5.1.5 (to be described).
 - If click Default, basic setup values are given (i.e., Menu: 95, Tour: 70, Pattern: 80).
 - For further details on setting, please refer to the PTZ camera manual.
- Click (←) ▲, ▼ direction buttons on the right-hand side of the ID column to set ID number (i.e., 0 ~ 9999) of each PTZ.
- While pressing (+) or (-) button, ID increases or decreases by 10 units.
- Choose 'OK' to confirm the setting.

4.4.3 Audio

- Please click (↔) DEVICES>Audio and the following screen will appear.

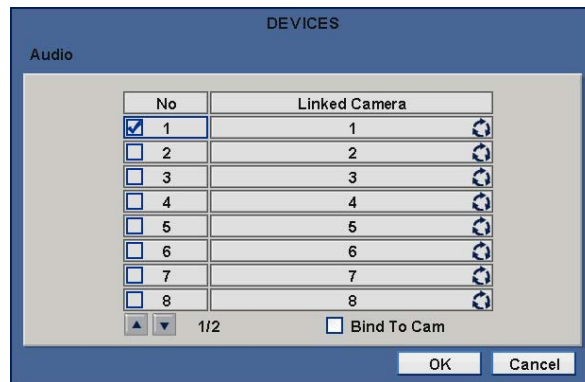

- The Audio menu will allow user to choose whether to record Audio.
- When a check box is marked on No column, corresponding audio and video from Linked Camera will be recorded. However, if the check box is not marked, audio will not record.
- If users check on bind to cam, then the audio and video of same channel will come out. If not, the audio of unchecked channel will not come out. In addition, this function will effect on live screen. (The default audio channel is No. 1)
- Choose 'OK' to confirm the setting.

4.4.4 Alarm In

- Please click (↔) DEVICES>Alarm In and the following screen will appear.

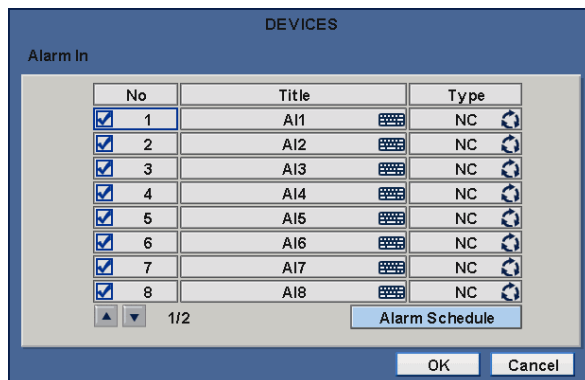

- The Alarm In menu will allow user to give title and to select the type of Alarm input.
- The Alarm In menu will allow user to give title and to select the type of Alarm input.

Alarm In Setting

- Click (↔) the keyboard icon on the right-hand side of each frame on Title column and the virtual keyboard will appear. Then, please register the title of Alarm input.
- When a check box is marked on No column, a corresponding Alarm starts operating. However, if user does not check the check box, the operation stops.
- Click (↔) each frame on Type column to select type of a corresponding Alarm input.
 - **NO**: contact is normally open (Normally open)
 - **NC**: contact is normally closed (Normally closed)
- User may change the type of all Alarm input at a time by clicking the Type box on the menu tab.
- Choose 'OK' to confirm setting.

Alarm Schedule

- Users are able to schedule the Alarm In deactivation period.
- Click '**Alarm Schedule**' and the following screen will appear.

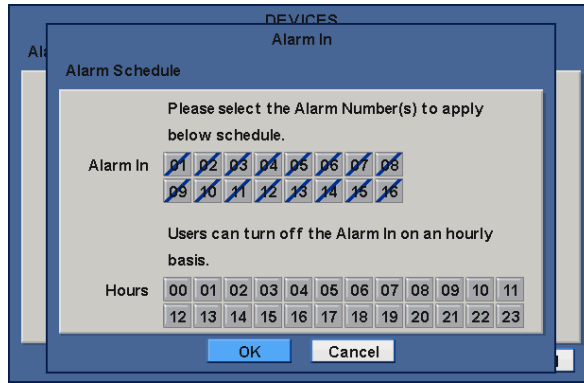

- Select the Alarm Input(s) to apply alarm in sensor deactivation according to Alarm schedule.
- Select the Hours to deactivate the alarm in sensor.
- Choose 'OK' to confirm setting.

4.4.5 Alarm Out

- Please click (←) DEVICES>Alarm Out and the following screen will appear.
- The Alarm Out menu will allow user to give title and to select the type and duration of Alarm output.

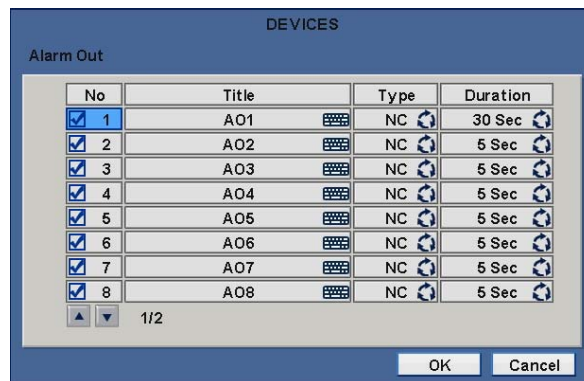

- Click (←) the keyboard icon on the right-hand side of each frame on Title column and the virtual keyboard will appear. Then, please register the title of Alarm output.
- When a check box is marked on No column, a corresponding Alarm output starts operating. However, if user does not check the check box, the operation stops.
- Click (←) each frame on Type column to select type of a corresponding Alarm output.
 - **NO**: contact is normally open (Normally open)
 - **NC**: contact is normally closed (Normally closed)
- User may change the type and duration of all Alarm output at a time by clicking the Type and Duration box on the menu tab.
- Choose 'OK' to confirm setting.

4.4.6 Serial In

NOTE

Please refer to "12 Serial In".

4.5 RECORD

- Please click (←) RECORD and the following screen will appear.

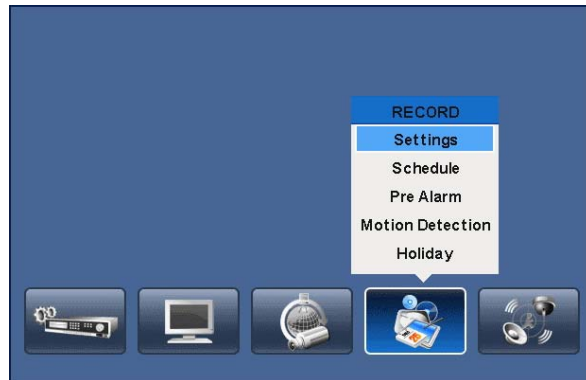

4.5.1 Setting

- Please click (←) RECORD>Settings and the following screen will appear.

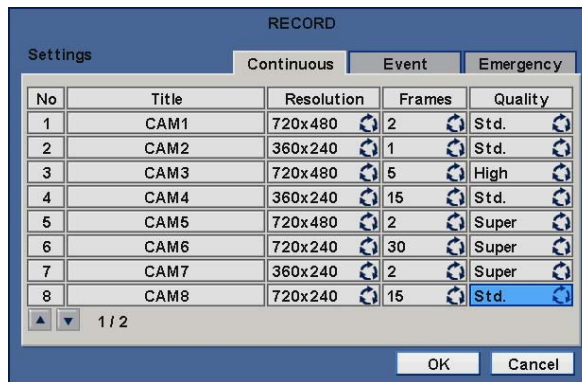

- There are three kinds of recording mode.
 - **Continuous:** record continuously.
 - **Event:** record only when Sensor or Motion calls.
 - **Emergency:** record when press **EMERGENCY** key.

NOTE

A, B, C and D Type does not have HD-SDI Input tap.

NOTE

E, F, G, H and I Type DVR can detect 1080i, 1080p or 720p HD-SDI signals. If user connected Camera before the booting, each signal is automatically detected and recognized (Auto Detection).

CAUTION

IF USER CONNECTS DIFFERENT TYPES OF HD-SDI SIGNALS WHILE DVR IS OPERATING. IT MAY CAUSE MALFUNCTIONS OF DVR.

-960H Type-

S, A, B, C and D Type

NTSC(PAL)	360x240 (360x288)	720x240 (720x288)	720x480 (720x576)	960x480 (960x576)
4 Channel DVR	120 (100)	120 (100)	120 (100)	120 (100)
8 Channel DVR	240 (200)	240 (200)	240 (200)	240 (200)
16 Channel DVR	480 (400)	480 (400)	480 (400)	480 (400)

**-HD-SDI Type-
E and F Type**

30/60hz (25/50hz)	960x480 (960x576)	1280 x 720	1920 x 1080
4 Channel DVR	Max. 30 (25) fps per Channel	Max. 30 (25) fps per Channel	Max. 30 (25) fps per Channel
8 Channel DVR	Max. 30 fps per Channel	Max. 30 fps per Channel	Max. 15 fps per Channel
16 Channel DVR	Max. 30 fps per Channel	Max. 30 fps per Channel	Max. 15 fps per Channel

G Type

30/60hz (25/50hz)	960x480 (960x576)	1280 x 720	1920 x 1080
4 / 8 / 16 Channel DVR	Max. 30 (25) fps per Channel	Max. 30 (25) fps per Channel	Max. 30 (25) fps per Channel

H Type

30/60hz (25/50hz)	960x480 (960x576)	1280 x 720	1920 x 1080
4 / 8 Channel DVR	Max. 60 (50) fps per Channel	Max. 60 (50) fps per Channel	Max. 60 (50) fps per Channel

I Type

•HD-SDI Input (CH 1 ~ 4)

30/60hz (25/50hz)	960x480 (960x576)	1280 x 720	1920 x 1080
4 Channel	Max. 30(25) fps per Channel	Max. 30(25) fps per Channel	Max. 30(25) fps per Channel

• Analog Input (CH 5 ~ 16)

NTSC(PAL)	360x240 (360x288)	720x240 (720x288)	720x480 (720x576)	960x480 (960x576)
12 Channel	360 (300)	360 (300)	360 (300)	360 (300)

NOTE

Frames are possible to be selected depends on Hz of input cameras (HD-SDI) or PAL/NTSC (Analogue) **Except E (8/16), F (8/16) Type.**

- HD-SDI: 1, 3, 5, 7, 15, 25, 50 (25 Hz & 50 Hz) / 1, 3, 5, 7, 15, 30, 60 (30 Hz & 60 Hz)
- Analog: 1, 3, 5, 6, 12.5, 25, 50 (PAL) / 1, 3, 5, 7, 15, 30, 60 (NTSC)

Continuous

- The Continuous menu will allow user to set recording mode.
- Each frame on Title column shows camera title registered in DEVICES>Camera/PTZ. User cannot change camera titles here.
- Click (↔) each frame on Resolution column to select recording resolution of a corresponding camera. User may select one of **360x240(288), 720x240(288), 720x480(576), 960x480(576), 1280x720 and 1920x1080.**
- Click (↔) each frame on Frames column to select recording rate of a corresponding camera. Recording rate varies by camera. Below lists the maximum recording rate of each camera.
- Click (↔) each frame on 'Quality' column to select recording quality of a corresponding camera. User may select its recording quality from **Super, High, Std and Low.**
- Click (↔) each frame on 'Duration' column to select recording duration (i.e., **10 second ~1 hour**) of a corresponding camera.
- User may change the setting values of Resolution, Frames, Quality and Duration at a time by clicking the menu tab.
- Choose 'OK' to confirm the setting.

Event

- Please click (↔) Event and the following screen will appear.



- The Event menu will allow user to set Event videos.
- Each frame on Title column shows camera title registered in DEVICES>Camera/PTZ. User cannot change camera titles here.
- Click (↔) each frame on Resolution column to select recording resolution of a corresponding camera. User may select one of **360x240(288)**, **720x240(288)**, **720x480(576)**, **960x480(576)**, **1280x720** and **1920x1080**.
- Click (↔) each frame on Frames column to select recording rate of a corresponding camera. Recording rate varies by camera. Below lists the maximum recording rate of each camera.
- Click (↔) each frame on 'Quality' column to select recording quality of a corresponding camera. User may select its recording quality from **Super, High, Std and Low**.
- Click (↔) each frame on 'Duration' column to select recording duration (i.e., **10 second ~ 1 hour**) of a corresponding camera.
- User may change the setting values of Resolution, Frames, Quality and Duration at a time by clicking the menu tab.
- Choose 'OK' to confirm the setting.

Emergency

- Please click (↔) Emergency and the following screen will appear Emergency.
- The Emergency menu will allow user to set Emergency videos.
- Each frame on Title column shows camera title registered in DEVICES>Camera/PTZ. User may not change camera titles here.

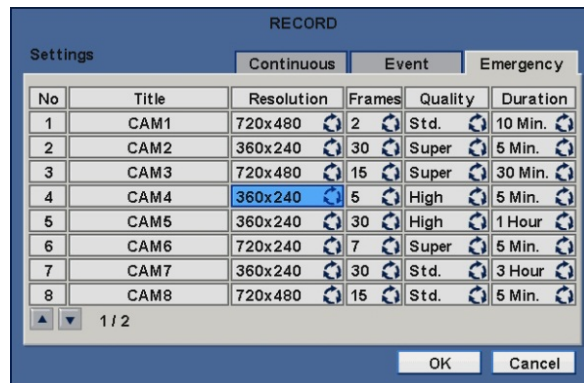

- Click (↔) each frame on Resolution column to select recording resolution of a corresponding camera. User may select one of **360x240(288)**, **720x240(288)**, **720x480(576)**, **960x480(576)**, **1280x720** and **1920x1080**.
- Click (↔) each frame on Frames column to select recording rate of a corresponding camera. Recording rate varies by camera. Below lists the maximum recording rate of each camera.
- Click (↔) each frame on 'Quality' column to select recording quality of a corresponding camera. User may select its recording quality from **Super, High, Std and Low**.
- Click (↔) each frame on 'Duration' column to select recording duration (i.e., **10 second ~ 1 hour**) of a corresponding camera.
- User may change the setting values of Resolution, Frames, Quality and Duration at a time by clicking the menu tab.
- Choose 'OK' to confirm the setting.

4.5.2 Schedule

- Please click (↔) RECORD>Schedule.
- Each weekday is composed of 24 'Time blocks'. Each block represent 1 hour.
- Click (↔) Camera frame to select Camera No. 1.
- Please set the recording mode as follows:
 - ① Mark a check box the desired recording mode in the schedule (i.e., Continuous, Alarm, Motion and Pre Alarm). If user wants to stop recording, please clear all check boxes.
 - ② Click block, row, column or all (square box) to register desired recording mode.
 - Click (↔) a block and only the block will be registered.
 - Click (↔) a row (S~H) and the entire row will be registered.
 - Click (↔) a column (00~23) and the entire column will be registered.
 - Click (↔) a square box (top-left side between 'S' and '00') and all the rows/columns will be registered.

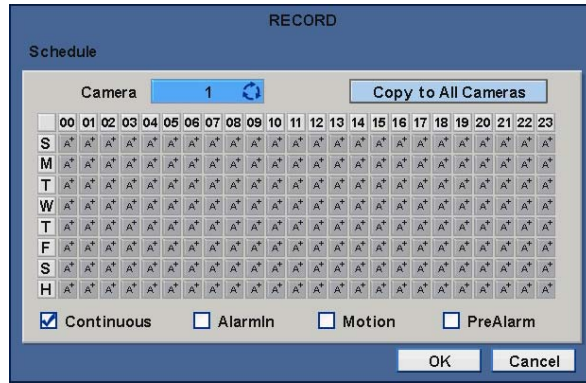

- Repeat the procedure for Camera Nos. 2 to 16. If user wants every camera to have the same mode, please click (←) Copy to All Camera.
- Below lists symbols of the respective recording modes.

- Continuous
- Alarm In
- Alarm In / Continuous
- Alarm In / Pre Alarm
- Motion
- Motion / Continuous
- Motion / Pre Alarm
- Motion / Alarm In
- Motion / Alarm In / Continuous
- Motion / Alarm In / Pre Alarm

- Choose 'OK' to confirm the setting.

NOTE

Holiday (H) registration can be done in the menu 4.5.5.

4.5.3 Pre Alarm

- Please (←) RECORD>Pre Alarm and the following will appear.
- Pre Alarm is effectively used when user selected recording mode by Alarm or Motion.
- The Pre Alarm will allow user to check, during playback, the previously recorded video before the record start time.



- Each frame on Title column shows camera title registered in DEVICES>Camera/PTZ. User cannot change camera titles here.
- Click (←) each frame on Frames column to select recording rate of a corresponding camera. Recording rate varies by camera.

- Click (←) each frame on 'Quality' column to select recording quality of a corresponding camera. User may select its recording quality from **Super, High, Std and Low**.
- Click (←) each frame on 'Duration' column to select recording duration (i.e., **10 second ~ 10 minute**) of a corresponding camera.
- User may change the setting values of Resolution, Frames, Quality and Duration at a time by clicking the menu tab.
- Choose 'OK' to confirm the setting.

4.5.4 Motion Detection

- Please click (←) RECORD>Motion Detection and the following screen will appear.



- The Motion Detection menu will allow user to set Motion detection alarm.
- Press **SETUP** key (or right mouse button) and the SETUP menu will appear.
- SETUP menu descriptions.
 - **Camera:** select camera for setup.
 - **Sensitivity:** select sensitivity (Low, Normal and High)
 - **Reverse Vert:** activate the entire column at the cursor's position.
 - **Reverse Horz:** activate the entire row at the cursor's position.
 - **Select All:** active all blocks.
 - **Deselect All:** deactivate all blocks.
 - **Copy to All Cameras:** The present channel setup applies to all other cameras. Only when click save button, the changed setup can be saved.
 - **Save:** save the new settings and go back to previous menu (page).
 - **Exit:** ignore the new settings and go back to previous menu (page).
 - **Cancel:** cancel Motion Setup menu.
- Choose 'OK' to confirm the setting.

4.5.5 Holiday

- Please click (←) RECORD>Holiday and the following screen will appear.



- The Holiday menu will allow user to register holidays. Please follow the registration procedure below.
 - ① Use arrow buttons in the Month Calendar to select Year and Month of holiday to be registered.
 - ►►: search subsequent 'Year'
 - ◀◀: search previous 'Year'
 - ►: search subsequent 'Month'
 - ◀: search previous 'Month'
 - ② Click (↔) on date user need to register as holiday.
 - ③ Click (↔) ADD button and the date just clicked on will be copied to the Schedule frame for registration.
 - ④ If wish to cancel the registration of a certain holiday, please click ☒ button next to the Schedule frame.
- Since holidays may vary every year, we recommend user to update on a regular basis.
- Choose 'OK' to confirm the setting.

4.6 LINK

- Please click (↔) LINK and the following screen will appear.

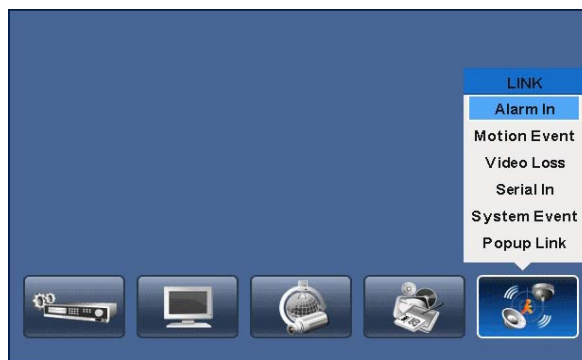

- The LINK menu will allow user to set recording modes of all kinds of alarms (Sensor, Motion Event, Video loss, System Event, etc.), alarm output, e-mail notification and the like.

4.6.1 Alarm In

- Please click (↔) LINK>Alarm In and the following screen will appear.
- Select cameras for recording while the alarm in sensor is in operation and alarm outputs and set up E-mail addresses for notification.
- Link Notification displays E-mail addresses registered in DEVICES>Network>Notification.
- Please follow the setup procedures below.
 - ① Click (↔) Alarm In frame and select Alarm In 1.
 - ② Select cameras for recording when Alarm In 1 is on. Please check a check box under Link Camera. More than two cameras can be set.
 - ③ Select alarm outputs to be worked when Alarm In 1 is on. Please check a check box under Link Alarm Out or R1~2. More than two alarm outputs can be set.
 - ④ Select E-mail addresses for notification when Alarm In 1 is on. Please check a check box under Link Notification. More than two E-mail addresses can be set.
 - ⑤ Repeat the above procedure for Alarm In 2~ Alarm In 16 (Up to 2 for **S and A Type** / Up to 4 for **B and E Type** / Up to 8 for **H Type** / Up to 16 for **C, D, F, G and I Type**).

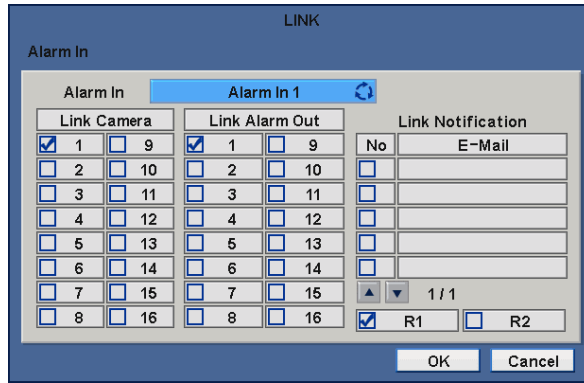

- Choose 'OK' to confirm the setting.

4.6.2 Motion Event

- Please click (←) LINK>Motion Event and the following screen will appear.

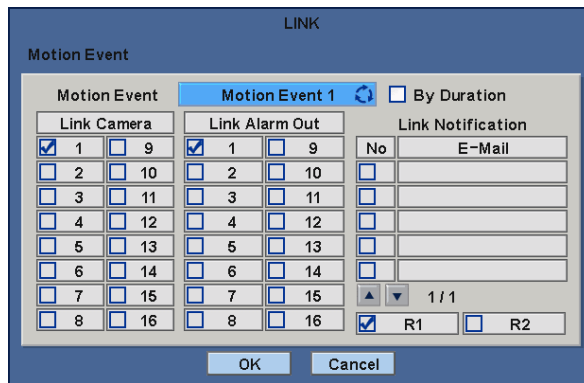

- Select cameras for recording while the motion sensor is in operation and alarm outputs and set up E-mail addresses for notification.
- Link Notification displays E-mail addresses registered in DEVICES>Network>Notification.
- Please follow the setup procedures below.
 - ① Click (←) Motion Event frame and select Motion Event 1.
 - ② Select cameras for recording when Motion Event 1 is on. Please check a check box under Link Camera. More than two cameras can be set.
 - ③ Select alarm outputs to be worked when Motion Event 1 is on. Please check a check box under Link Alarm Out or R1~2. More than two alarm outputs can be set.
 - ④ Select E-mail addresses for notification when Motion Event 1 is on. Please check a check box under Link Notification. More than two E-mail addresses can be set.
 - ⑤ Repeat the above procedure for Motion Event 2~ Motion Event 16.
- Click (←) By Duration box to set up the recording duration and prevent recording caused by event.
- The duration time can be controlled by previous setting mode: RECORD>Settings>Event
- Choose 'OK' to confirm the setting.

4.6.3 Video Loss

- Please click (←) LINK>Video Loss and the following screen will appear.

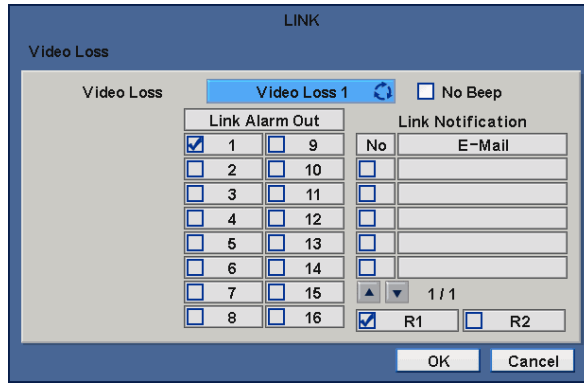

- Select alarm outputs and set up E-mail addresses for notification when Video Loss occurs.
- Link Notification displays E-mail addresses registered in DEVICES>Network>Notification.
- Please follow the setup procedures below.
 - ① Click (←) Video Loss frame and select Video Loss 1.
 - ② Select cameras for recording when Video Loss 1 is on. Please check a check box under Link Camera. More than two cameras can be set.
 - ③ Select alarm outputs to be worked when Video Loss 1 is on. Please check a check box under Link Alarm Out or R1~2. More than two alarm outputs can be set.
 - ④ Select E-mail addresses for notification when Video Loss 1 is on. Please check a check box under Link Notification. More than two E-mail addresses can be set.
 - ⑤ Repeat the above procedure for Video Loss 2~ Video Loss 16.
- Click No Beep to deactivate alert sounds from video loss. Apply to all channels.
- Choose 'OK' to confirm the setting.

4.6.4 Serial In

- Please click (←) LINK>Serial In and the following screen will appear.

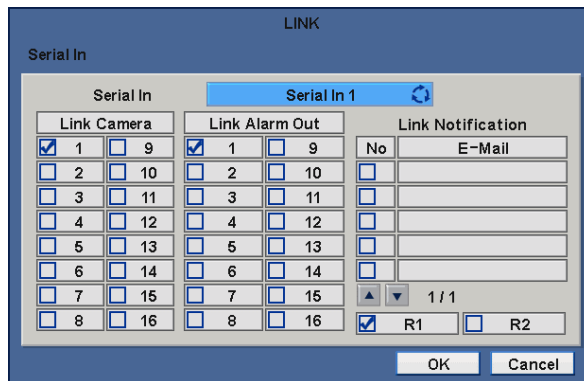

- Select cameras for recording while the Serial In is in operation and alarm outputs and set up E-mail addresses for notification.
- Link Notification displays E-mail addresses registered in DEVICES>Network>Notification.
- Please follow the setup procedures below.
 - ① Click (←) Video Loss frame and select Serial In 1.
 - ⑥ Select cameras for recording when Serial In 1 is on. Please check a check box under Link Camera. More than two cameras can be set.
 - ⑦ Select alarm outputs to be worked when Serial In 1 is on. Please check a check box under Link Alarm Out or R1~2. More than two alarm outputs can be set.
 - ⑧ Select E-mail addresses for notification when Serial In1 is on. Please check a check box under Link Notification. More than two E-mail addresses can be set.
 - ⑨ Repeat the above procedure for Serial In 2~ Serial In 4.
- Click No Beep to deactivate alert sounds from video loss. Apply to all channels.

- Choose 'OK' to confirm the setting.

4.6.5 System Event

- Please click (←) LINK>System Event and the following screen will appear.

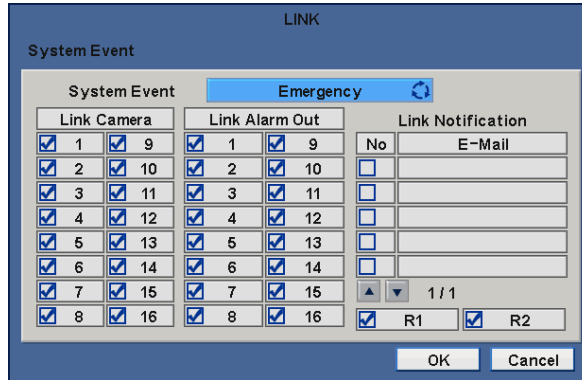

- Select recording cameras and alarm outputs while Emergency recording using **EMERGENCY** key and set E-mail addresses for notification.
- Link Notification displays E-mail addresses registered in DEVICES>Network>Notification.
- Please follow the setup procedures below.
 - ① System Event frame displays Emergency, which user does not have to change.
 - ② Select cameras for recording when emergency occurs. Please check a check box under Link Camera. More than two cameras can be set.
 - ③ Select alarm outputs to be worked when emergency occurs. Please check a check box under Link Alarm Out or R1~2. More than two alarm outputs can be set.
 - ④ Select E-mail addresses for notification when emergency occurs. Please check a check box under Link Notification. More than two E-mail addresses can be set.
- Choose 'OK' to confirm the setting.

4.6.6 Popup Link

- Please click (←) LINK>Popup Link and the following screen will appear.

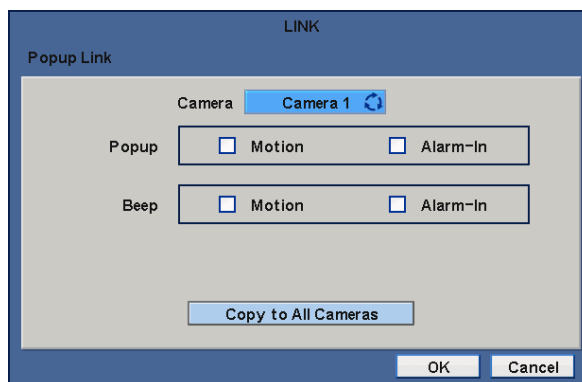

- When Motion or Alarm-In is detected, user can select a popup or beep sound for warning, or have a particular channel of interest to pop-up on Spot Screen.
- Please follow the setup procedures below.
 - ① Select camera
 - ② **Popup**: Please check a check box under making the popup screen for main monitor.
 - ③ **Beep**: Please check a check box under making beep sound.
- Click Copy to All Cameras button, then the present channel setup will apply to all other cameras.
- Choose 'OK' to confirm the setting.

5. OPERATION INSTRUCTION

5.1 Viewing

5.1.1 First Image

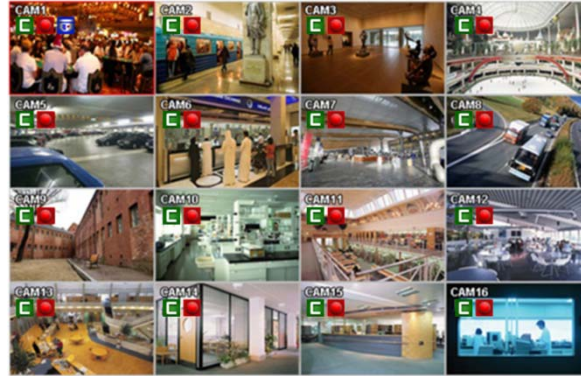

- Power on DVR and the following live video will appear, while viewing and recording at the same time.



- The screen will display date/time and icons below.

Icon	Description
	Continuous recording mode
	Event recording mode (Motion, Alarm In)
	In recording
	PTZ registration/PTZ mode
	In Audio recording
	CMS Access Indication/No. of accesses (up to 16)
	In channel sequencing
	Setup in HDD Overwrite mode
	Setup in HDD None Overwrite mode(recording)
	Setup in HDD None Overwrite mode(HDD Full)
	Master Alarm Enabled.

- On the right bottom side of the screen, disk usage will show by %.
- On the left top side of each channel screen, icon will show as its operation.
- At the normal state, HDD Overwrite mode is on and icon shows.
- When Overwrite mode is off Information>Record>Overwrite Setting), will show. And when the disk becomes full, the icon will be changed to .

- Click Emergency recording button,  icon will show.
- Click Audio button,  icon will show. And click channel button, then user can change only audio channel.

NOTE

When front key does not work well, please check whether the audio icon  is activated on the screen.

5.1.2 View Format

- The available view formats when the Main Monitor is in viewing mode include Full Screen, Split Screen, Channel Sequencing Screen and PIP screen.
 - **Full Screen:** Please press camera select key (**1~16**) to view the corresponding camera image in full view format.

NOTE

Using a mouse: Double click to view the corresponding camera image in full view format and click one more time to back to Split Screen.

- **Split Screen:** Please press **DISPLAY** key and the available split screens (or multi-window view formats) will display alternately (i.e., 2x2, 3x3 and 4x4).
- **Channel Sequencing:** Please press **SEQUENCE** key to display images in sequencing view format periodically. This automatic sequence function is not limited to the full screen format, but can be used in any view mode. In 8 channel DVR, 4-camera sequencing view mode is possible and in 16 channel DVR, 4 or 9-camera sequencing view modes are possible.

5.1.3 Digital Zoom

- Select a Channel into Full Screen.
- Drag a portion to zoom by mouse.
- Double click mouse to exit zoomed screen.
- This function works only in the full screen. Users cannot use the digital zoom function in split screen format, channel sequencing or PIP mode.

5.1.4 Freeze Live Image

- Press **FREEZE** key while viewing live image to pause the image.
- The Freeze function works only in the full screen or split screen formats. Please do not use this function in channel sequencing mode or in PIP mode.

5.1.5 Pan / Tilt Control

- Press **PTZ** key to adjust PTZ cameras connected to DVR. Pan/Tilt mode is available only in the full screen format.

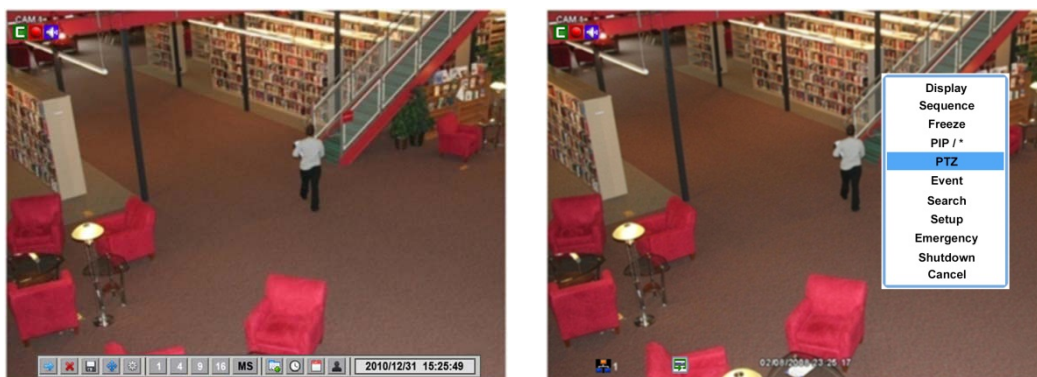



- In Pan/Tilt mode, the  icon is displayed on the bottom of the screen.
- Following is the key usage found in Pan/Tilt mode.

Key	Function
	Up/Down/Left/Right rotation
	Zoom out
	Zoom in
	Focus near
	Focus far
	Iris Close
	Iris Open
	Save Preset
	Go to the Preset
	Go to OSD main menu
	Run Group Tour 1~9
	Run Pattern 1~9

- To use a mouse in Pan/Tilt mode, please move the cursor to the lower portion near the center of the screen. To use front button in Pan/Tilt mode, please push setup button.
- To activate PTZ control OSD menu, user must move the cursor to the bottom right portion of the screen. A key pad control will show as follows:



- To save current camera number, select Preset No and  button click.
- To move to preset, select preset No and  button click.
- Available 1 ~ 255 Preset numbers can saved it depends on camera specification.
- As explained earlier in 4.4.2., press Menu button to pop-up PTZ camera OSD setup screen and set up Tour and Pattern items.
 - Since these functions make use of a memory function of the camera itself, user should set them in Camera OSD.
 - Once user completes the setup, close the Camera OSD menu.
 - User can conveniently use Tour and Pattern functions simply by clicking Tour and Pattern buttons.
 - Particulars on how to setup each function on OSD Menu are found in the manual of a corresponding camera.

NOTE

Suppose a command for using Tour function is 71 ~ 79 + Preset and if you had set Tour to 70, use Preset No: 1 ~ 9 + Tour button to benefit the Tour function (70 + 1~9).

NOTE

It is required to set Menu as Preset number 95 from camera in order to call camera menu display by clicking 'menu' button or using 95+Goto button.

5.1.6 System Log

- Press **EVENT** key and the System Log screen will appear.

Date/Time	Log
03/09/2009 PM 01:22:35	NTP Sync : Success
03/09/2009 PM 01:22:35	After Time Adjusted
03/09/2009 PM 01:22:35	Before Time Adjusted
03/09/2009 PM 01:08:16	CD/DVD Archive : Success
03/09/2009 PM 12:22:32	NTP Sync : Success
03/09/2009 PM 12:22:32	After Time Adjusted
03/09/2009 PM 12:22:32	Before Time Adjusted
03/09/2009 AM 11:22:29	NTP Sync : Success

▲ ▼ 1 / 29 (229)

Close

- Please refer 'SETUP>SYSTEM>System Log' to learn different events listed on the System Log and see how to delete the System Log.

5.1.7 Key Lock

- Press AUDIO>FF>FORWARD keys in sequence to operate the key lock function. This function is indicated by  icon in the lower portion on the right-hand side of the screen.
- Once the Key Lock function is activated, user cannot use any key. If wish to use a key, please enter the correct password to release the key lock function. If Password is not required, simply press ENTER ↵ key.

5.1.8 Emergency Recording

- When user presses **EMERGENCY** key, recording starts right away regardless of preset recording mode.
- Emergency recording is not operated while SETUP.
- Press Emergency key one more time to stop the emergency recording.

5.2 Search

- This involves searching recorded video to playback the wanted video of a specific date and time.
- Press **SEARCH** key on the viewing screen, or Click Search menu at "Function Keys" and the following Search menu will appear.

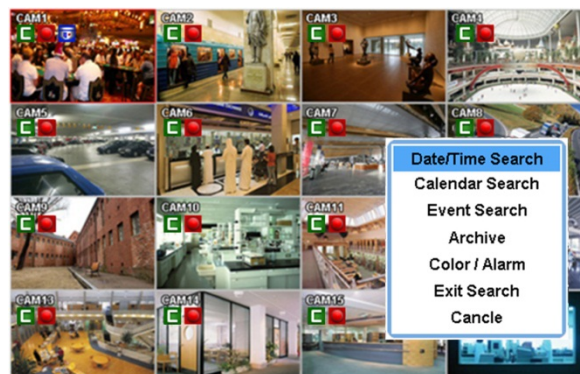

- There are three ways to search video, i.e., by date/time and by calendar.
 - **Date/Time Search:** search by inputting date/time.
 - **Calendar Search:** search by using calendar.
 - **Event Search:** search by event.

5.2.1 Date / Time Search

- Please click (↔) Date/Time Search in SEARCH menu and the following input box will appear.

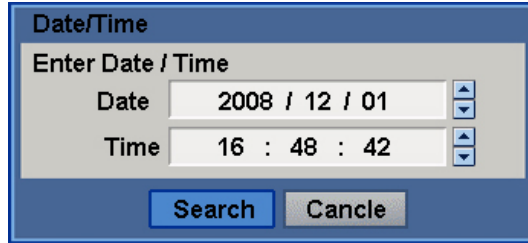

- Follow the procedure below to search video by date/time.
 - ① Click (↔) the date and/or time whichever user needs to change and block the item. The designated item will be marked in a square.
 - ② Click ▲, ▼ buttons on the right-hand side to adjust the values.
- Choose 'Search' to confirm the setting. Then, the selected video will be played back.
- Playback continues from the designated time until the last recording time.

5.2.2 Calendar Search

- Please click (↔) Calendar Search in SEARCH menu and the following input box will appear.

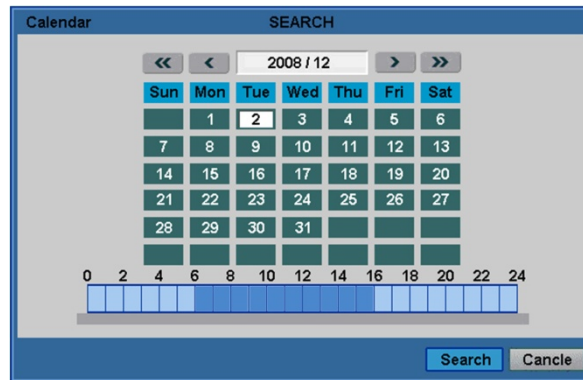

- Dates and Time with recorded data available will be high-lighted.
- Follow the procedure below to search video by calendar.
 - ① Select Year and Month by using the arrow buttons in the calendar.
 - ►►: search subsequent 'Year'
 - ◀◀: search previous 'Year'
 - ►: search subsequent 'Month'
 - ◀: search previous 'Month'
 - ② Click (↔) a date. The date will be displayed in black color.
 - ③ Click (↔) the box on the time indication bar to select the search time. The selected time zone will be focused in different color.
 - ④ Click (↔) the selected time box to show pop-up window on the screen, If there is a recorded data.

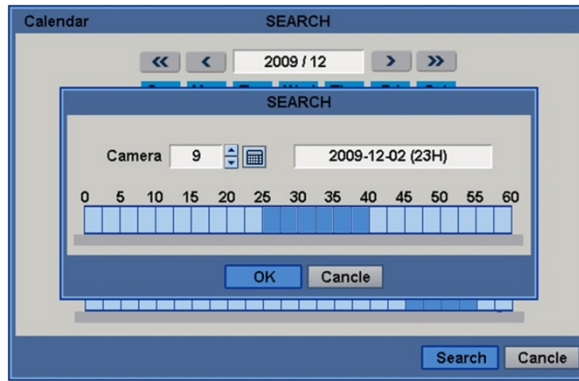

- ⑤ The screen will show selected date/time.
 - ⑥ Click ▲▼ button for selecting cameras.
 - ⑦ Click  then recorded data will be highlighted on the bar.
 - ⑧ Selected camera will show the time bar 0-60 and It will be marked on 2.5minutes basis during selected time zone.
 - ⑨ Click (←) the box on the time indication bar to select the start time of the video playback
- Click (←) Search key to start playing back the selected video.
 - Playback continues from the designated time until the last recording time.

NOTE

Click (←) search button to show entire channel search based on different time frames

5.2.3 Event Search

- Please click (←) Event Search in SEARCH menu and the following input box will appear.
- This involves searching recorded video to playback the selected video of a specific date and time.
- Press **SEARCH** key on the viewing screen, or use the mouse wheel (central button) and the following Search menu will appear.

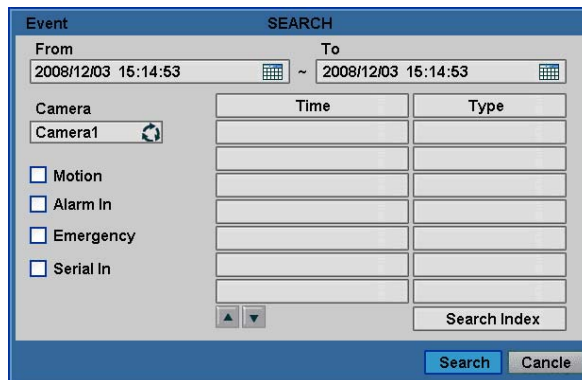

- ① Designate Event Search start time.
- ② Designate Event Search end time.
- ③ Select camera (video) to search data.
- ④ Check a check box (Motion / Alarm In / Emergency / Serial In) Check box.
- ⑤ Click on Search Index button to recorded search event data.

5.3 Playback

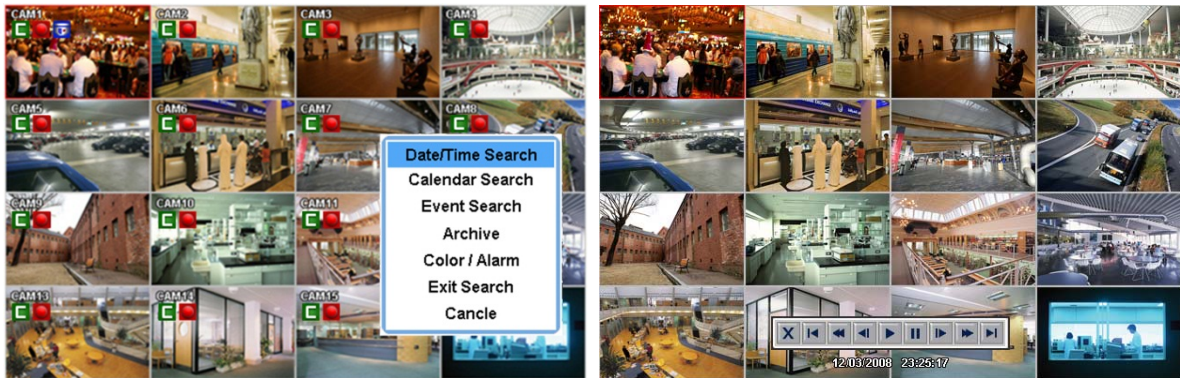

- This involves searching recorded video to playback the wanted video of a specific date and time in search mode.
- Press **SETUP** key or please press the mouse right button and click in Playback mode. Then, the following screen will appear.











- There are three ways to search video, i.e., by date/time and by calendar.
 - Date/Time Search: search by inputting date/time.
 - Calendar Search: search by using calendar.
 - Event Search: search by event.
- There are three other functions in playback mode;
 - Archive: The Archive function will allow user to copy the recorded video (moving images and still images) from a storage device (USB memory stick, DVD-RW).
 - Exit Search: From playback display to live display.
 - Cancel: Hide menu in playback mode.
- Playback mode runs in the available maximum number of split screen format. To change the viewing mode, please press **DISPLAY** key or **Camera Select** key (1~16).

NOTE

Using a mouse: Double click to view the full screen and double click one more time to back to Split Screen.

- Move the cursor of the mouse and the keypad control will appear at the bottom near the center of the screen.
- Every time user presses the **PLAY/PAUSE** key during playback mode, it is changed to '1X PLAY' and 'PAUSE'. The displayed sign on the screen also changes from  to .
- Following is the key usage found in playback mode. User may also use the keypad provided on the screen.

Go to Start		• Go to start of recorded data
REW		• Fast reverse playback (changes to x2, x4, x8, x16, x32, x64 and Extreme with each press)
BACKWARD		• Frame-by-frame reverse still image playback
PLAY		• Playback mode: 1X PLAY
PAUSE		• PAUSE
FORWARD		• Frame-by-frame forward still image playback
FF		• Fast forward playback (changes to x2, x4, x8, x16, x32, x64 and Extreme with each press)
Go to End		• Go to end of the recorded data

- Press **SEARCH** key to stop playing back video.

5.4 One-touch Playback

- Press the **PLAY/PAUSE** key or double click the mouse wheel (central button) in the viewing mode. Then, user will be able to view the wanted recorded video right away without going through the search procedure. The video plays back the recorded video from the last one minute. To stop playing back the video, please press **SEARCH** key.

5.5 Digital Zoom in Playback

- Users are able to use Digital Zoon function in full screen playback.
- Drag a partition on to the screen, then the partition will enlarge as a full screen.
- Double click the left button of mouse to exit the zoom-in screen.

5.6 Archive

- The Backup function will allow user to copy the recorded video (moving images and still images) from a storage device (USB memory stick, DVD-RW).
- Please execute Backup Live or playback.
- Follow the backup procedure.
 - ① Press **ARCHIVE** key. In case of using a mouse, please press the mouse right button and click in Archive. Then, the following screen will appear.

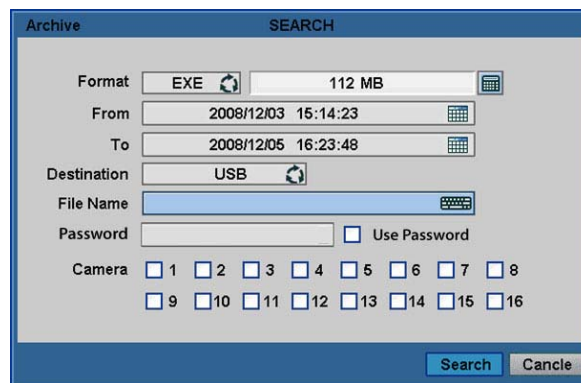

- ② Click (←) Format frame to select EXE, AVI or JPEG. Choose EXE or AVI for storing moving images; and JPEG for still images.
- ③ Click (←) the keyboard display on the right-hand side of FROM frame to set the storage start time.
- ④ Click (←) the keyboard display on the right-hand side of TO frame to set the storage end time.
- ⑤ Click (←) Destination frame to select a storage device out of USB and DVD-RW.
- ⑥ Click (←) the keyboard display on the right-hand side of File Name frame to input a file name. User does not need to input extension (exe, avi, jpeg). Please note that the file is not going to be stored unless user inputs a name.
- ⑦ To set the Password to the file that users want to save, mark the check box of “use Password”. Then, Click the keyboard button and set a password.
- ⑧ Check a check box next to a camera with the video that want to store. User can archive multi-channel at the same time.
- ⑨ Click (←) the Calculator button  on the rightmost side of Format line to check the data capacity for backup. The capacity will show only for EXE Archive.
- ⑩ Click (←) Start button. Then, Progress bar will appear and the storage process proceeds. The progress bar does not show actual progress time. Depending on to the file size, it will appear again even after it shows 100%. It is important not to detach storage device until DVR displays “Archive Success” message.
- ⑪ If the storage is done properly, Archive Success message will pop up. Please choose ‘OK’ to confirm. If the storage fails, Archive Fail message will pop up. In this case, user must try again.

NOTE

Please do not use jpeg format while archiving in live mode.

NOTE

Please do not change the settings by DVR or CMS, while back up.

NOTE

Please enter all the necessary information before Click 'START'.

NOTE

If the When the targeted file size is over 2GB, press " **Search** " button on the right again after the first "ARCHIVE SUCCESS". And DVR will continue to archive to another file with the extension of "-002" Automatically added. In case of DVD media, change the media after the first file is finished and press " **Search** " to continue to the rest of progress.

CAUTION

PLEASE DO NOT USE THE SPACE WHEN ENTER BACKUP FILE NAME.

CAUTION

WHILE BACKUP PROCEDURE, PLEASE DO NOT DETACH STORAGE DEVICE OR POWER OFF THE DVR. OTHERWISE, IT MAY CAUSE PERMANENT DAMAGE TO THE DVR OR THE STORAGE DEVICE. IN SUCH CASE, USER MUST REBOOT THE DVR. IF THE DVR DOES NOT OPERATE PROPERLY, USER MIGHT NEED TO CONTACT SERVICE CENTER.

CAUTION

WHEN ARCHIVING IN AVI FORMAT, IT ONLY SUPPORTS 1CH AND DOES NOT SUPPORT AUDIO AND PASSWORD FEATURES.

5.7 Menu Bar

- Menu bar enables users to control all function as front button on the OSD screen.



- Move the mouse cursor to bottom around Date and Time indication then Menu bar will show up on the live screen.

- Each icon functions as below;



: Exit the Menu Bar



: Safely turn off the DVR



: Enter Archive mode



: Enter PTZ control mode



: Enter Setup mode



: Turn the display as 1 channel full screen. Additional click on full screen, it will change to next channel in sequence.



: Turn the display as 4 channels split screen. Additional click will change to the next four channels in sequence.



: Turn the display as 8 channels split screen. Additional click will change to the next eight channels in sequence.



: Turn the display as 16 channels split screen, There is no changes when additional click on 16 channels split screen.



: Select the multisport split mode by clicking MS and 1/4/9/16 buttons.



: Play Instant Playback



: Enter Calendar Search



: Date and Time Search



: Enter Event Search

2010/12/31 15:45:29

: Showing current Date & Time

5.8 Alarm Out Control

- Please click (↔) **Color / Alarm** in SEARCH popup menu or in front panel and the following input box will appear.

NOTE

This function is enabled only when **LIVE MODE** and **4 SPLIT SCREEN MODE** or **HIGHER**.

NOTE

S Type has 1 alarm out, **A Type** has 1 Relay out, **B Type** has 2 Relay out, **C and D Type** have 2 Relay out and 4/8/16 Alarm out, **E type** has 1 relay out and 1/4 alarm out, **F, G and H Type** have 2 relay out and 4/8/16 alarm out and **I Type** has 2 Relay out and 8/16 Alarm out.

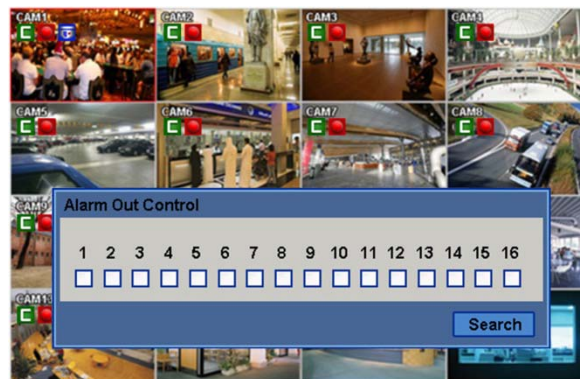

- Please click (↔) **Color / Alarm** in SEARCH popup menu or in front panel and the following input box will appear.
- Choose 'Close' to confirm the setting.

CAUTION

ALTHOUGH USERS TURN ITS SYSTEM SETTING TO DEFAULT, THE ANALOG OUTPUT WILL STAY PREVIOUS OUTPUT METHOD AND NOT EFFECT BY THE DEFAULT SETTING.

CMS Pro
Full-featured Enterprise Class Surveillance Solution

User`s Manual



6. CMS Pro

6.1 CMS Pro Features

6.1.1 Introduction

- The CMS Pro is a central surveillance system solution that monitors multiple sites with video, audio and event signals from DVR over networks.
- The software supports different windows of live viewer, playback player, interactive map viewer, various search panes and event signal monitoring panes.

6.1.2 Features

- This program does not limit the number of units to register and monitor. The program displays up to 512 live videos; up to 256 channels on one screen and 256 channels on the other screen (*see note below). The program supports as many monitors as a PC supports. Users may open windows or panes of live video displaying, data playing, event signal monitoring, map displaying, etc. Users can compose the central management system by choosing required widows or panes.
- The software supports different windows of live viewer, interactive map viewer, and event signal monitoring panes.
- The program displays event signals in real-time by receiving from devices over the network.
- On the program, users may control PTZ cameras and relay outputs on the server or DVR. By attaching microphone and speaker system to devices on site, users may make bi-directional audio communication over the network.
- The main Search window provides users with various ways of searching data on DVR.
- The map supports multi-layer structure, so that each map on different layers can respond interactively. On the map, users may lay out icons of each device. Event signal triggers the icons on the map to blink, so that users may monitor event signals on the map. And Users can check the live view of individual camera on the map by clicking the video icon.
- With 5 different types of search function, users can search the recorded data according to user's needs.

NOTE

It is recommended to connect Max. 16 HD-SDI (Full HD) cameras with CMS Pro.

WARNING

CONNECTING MORE THAN 16 HD-SDI (FULL HD) CAMERAS MAY RESULT IN MALFUNCTION OF THE SOFTWARE. TO CONNECT MORE THAN 16 HD-SDI (FULL HD) CAMERAS, PLEASE ENABLE DUAL STREAMING OPTION ON THE DVR.

WARNING

TO PREVENT OVERLOAD OF THE USER PC. CMS PRO IS DESIGNED TO REDUCE THE NETWORK STREAMING FRAME RATE TO 1 FRAME PER SECOND REGARDLESS OF ITS SETTING WHEN MORE THAN 64 CHANNELS ARE CONNECTED SIMULTANIOUSLY.

6.1.3 System Requirements

- CMS Pro may not run properly if the PC does not meet minimum requirements. Other programs should not run on the same PC where this is running. Otherwise, CMS Pro software may not perform as designed.

	Minimum	Recommended
CPU	Intel Core i5	Intel Core i7
Main Memory	2GB	4GB or higher
Video Memory	1GB	2GB or higher
Display Resolution	1024 x 768 (with 32bit color) or higher	
HDD Storage Space	160GB or higher	
Network	100~1000 Mbps Fast Ethernet	
Operating System	Windows XP Professional SP3 / Windows 7 (32/64) / Windows 8 (32/64)	
Others	DirectX 9.0 C or higher	

6.2 Installation

6.2.1 Software Installation

- Please follow the program installation procedures below.

① If an old version of CMS Pro program was installed, completely uninstall or delete the old version.

CAUTION

USERS SHOULD COMPLETELY REMOVE CMS PRO PROGRAM OF AN OLD VERSION BEFORE INSTALLING NEW VERSION IN ORDER TO REDUCE COLLISION.

- ② Insert the provided CD in a PC.
- ③ Run the CMS Pro Setup.exe file.
- ④ When the following screen appears, click “Next.”

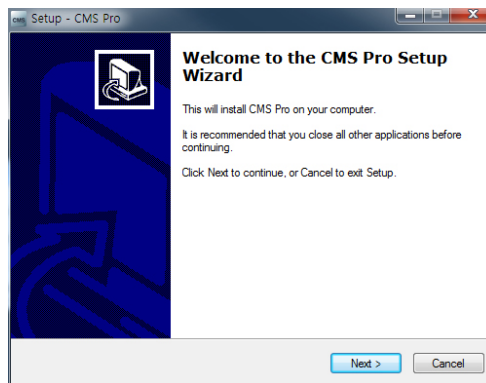

- ⑤ When the following screen appears, select folder and click “Next.”

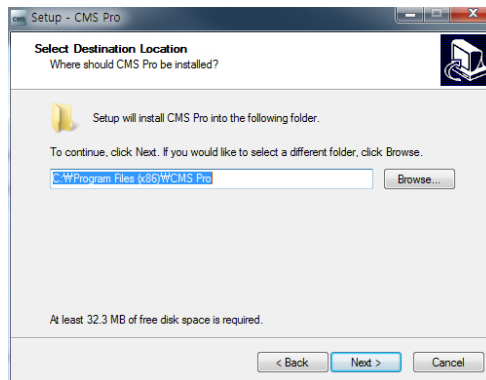

- ⑥ When the following screen appears, select the check box according to user's preference and click “Next.”

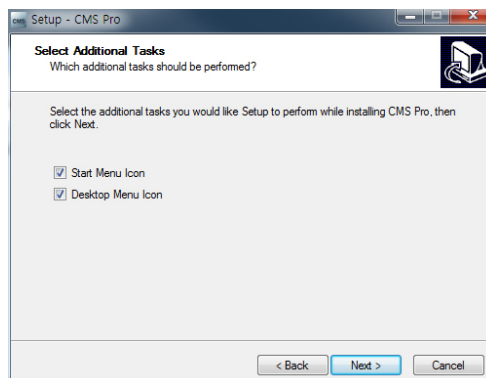

⑦ When the following screen appears, click “Install.”

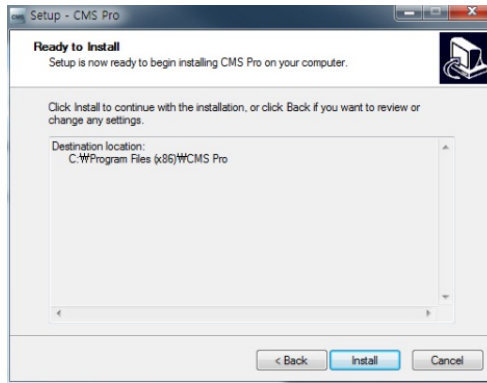

⑧ When the following screen appears, click “Finish” to complete the installation.



NOTE

- If the PC has a previously installed CMS Pro, the installer asks whether to overwrite the existing DB or not. The DB contains setting values on the program. If desired to maintain the existing values, click ‘No’ button.

6.2.2 Login

6.2.2.1 Login Process

- Open the CMS Pro. Users may open it by selecting the execution file through ‘Start’ menu [Start] – [CMS Pro] or by double-clicking the execution icon on the background.
- Select a user ID in the ‘Login’ window. Users may see the entire list of IDs that are registered into the program by clicking on the drop-down menu in the right-side. Initially, only the Administrator is registered as default.

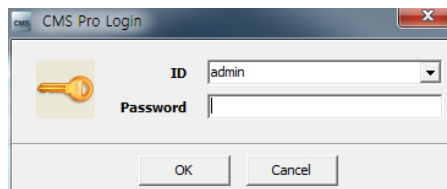

- Enter the corresponding password with the selected ID. The default password of the ‘Administrator’ ID is ‘1111’. Administrator may change the password in the program.

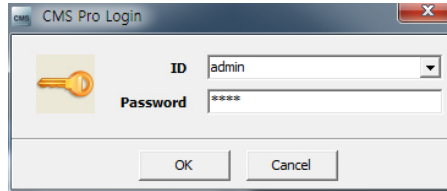

NOTE

Users may change the password in [Setup] – [Change Password] menu. For the detailed information, please refer to the 'Chapter 6.4.7 Change Password' page.

The CMS Pro saves settings and layouts on the program of the current user when the program is closed.

6.3 Menu

- Below shows the brief explanation of each part on the screen.

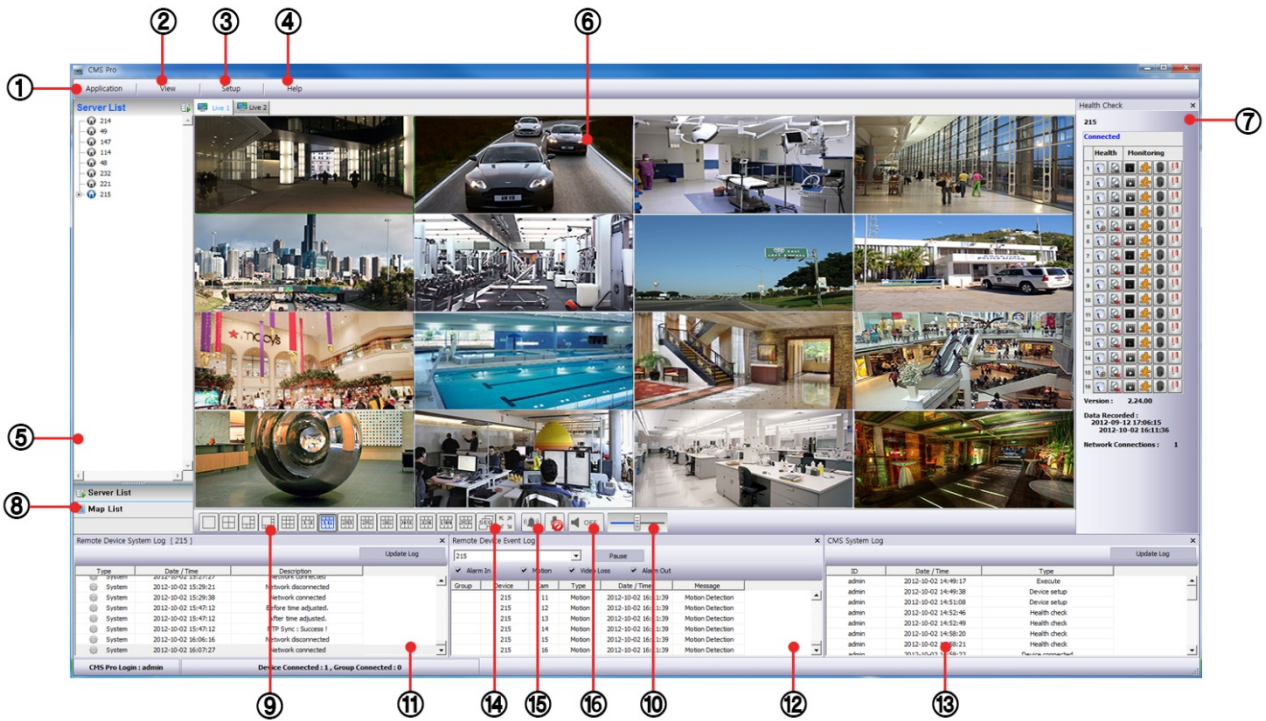

1	Application
2	View set
3	Setup menu
4	Help menu
5	Server list pane
6	Display windows
7	Health check pane
8	Map list pane
9	Screen split selection icons
10	Audio control bar
11	Remote device system log pane
12	Remote device event log pane
13	CMS system log pane

14	Sequencing
15	Event Beep On / Off
16	Audio Status icon

6.4 Setup

6.4.1 Local Setup - Device

- Please make sure the network setting of DVR has been done properly prior to the remote connection setting.

6.4.1.1 Remote Site Connection Setup

- Click Setup – Local Setup – Device to enter the setup and a dialog will pop up as below picture.

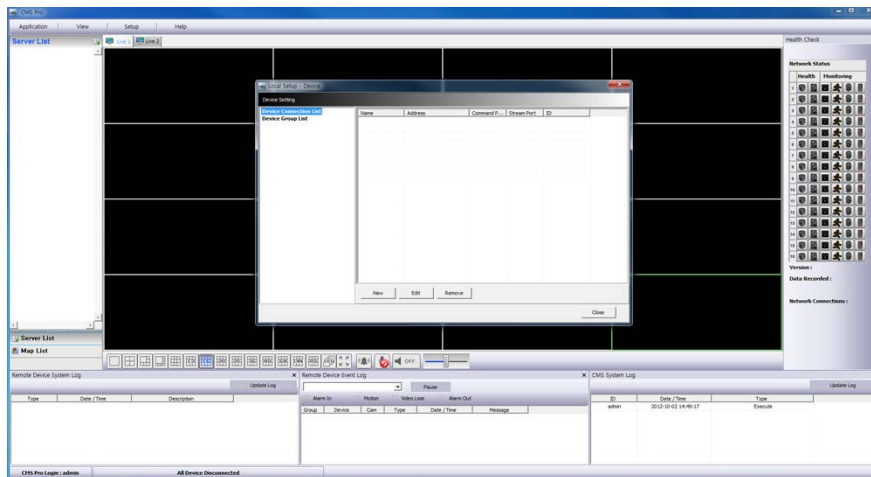

6.4.1.2 New Device Register

Device

- Select “Device Connection List” on left-hand side and click [New] to register new devices.

- Describe the connection information as below. User must fill in where information requested in **bold**.
 - **Device Name**: Type the DVR name to be displayed in the server list pane. Please note that this name has no relation to the ID registered in DVR. Users may create a name to be easily distinguished.
 - **Description**: Type brief description of the site
 - **IP Address**: Input IP address or Domain Name of DVR (check from the SETUP>DEVICES>Network in DVR)
 - **Command Port**: Input Administrator’s number among port numbers set in DVR (check from the SETUP>DEVICES>Network in DVR). Default port number is **5920**
 - **Stream Port**: Input Video/Audio number among port numbers set in DVR (check from the SETUP>DEVICES>Network in DVR). Default port number is **5921**

- **Login ID:** Type authorized ID of the DVR. Default ID is **admin**.
- **Login Password:** Type correspond password of the ID. Default Password is **1111**
- **Confirm Password:** Retype the password to confirm
- **Pop up Display:** User can setting either video pop up or beep on corresponding channel when event occurs.

Camera

- Choose a camera name between DVR and CMS setting or both.
 - Device Camera Name: Display camera name of DVR.
 - CMS Camera Name: Display Camera name of CMS.
 - Both (Device-CMS) Camera Name: Display both as [DVR name]-[CMS name].
- If users mark the “Display to Server List”, camera name is displayed in the server list.
- Type the name of each camera in “Camera Name” item.
- Users will be able to type not only in English but also in their own languages.
- It is possible to erase all names by clicking “Clear all names”.
- Save and close the setting panel by clicking “OK”.
- If users wish to exit without saving, then click “Cancel”.
- If users mark the “Re-connect when abnormal disconnected”, CMS Pro will automatically verifies the network condition, then tries reconnecting to the site.

Scan Device

- This function automatically detects and registers units where currently connected to local network.
- Click “Scan Device”, then following will pop up.

IP Address	Command P...	Stream Port	MAC Address
192.168.10.147	5920	5921	00:19:9c:05:12:4b
192.168.10.148	5920	5921	00:19:9c:05:02:7cc
192.168.10.205	5920	5921	00:19:9c:04:8a:0ce
192.168.10.151	5920	5921	00:19:9c:05:07:2af
192.168.10.118	5920	5921	00:19:9c:05:27:a60
192.168.10.130	5920	5921	00:19:9c:04:ff:19
192.168.10.240	5920	5921	00:19:9c:04:44:64
192.168.10.45	59205	59215	00:19:9c:04:35:ee
192.168.10.145	5920	5921	00:19:9c:03:a2:25
192.168.10.46	59206	59216	00:19:9c:04:45:42
192.168.10.247	5920	5921	00:19:9c:05:07:dd
192.168.10.244	5920	5921	00:19:9c:05:28:23
192.168.10.61	7920	7921	00:19:9c:05:13:29
192.168.10.106	5920	5921	00:19:9c:04:e7:15
192.168.10.137	5920	5921	00:19:9c:03:a2:07
192.168.10.225	5920	5921	00:19:9c:04:4f:c9
192.168.10.163	5920	5921	00:19:9c:05:11:b6
192.168.10.146	5920	5921	00:19:9c:05:07:89
192.168.10.49	59209	59219	00:19:9c:05:06:bd
192.168.10.162	5920	5921	00:19:9c:04:e6:bb

6.4.1.3 Edit Registered Site

- Select a site to adjust on local setup window and click “Edit”
- Change the setting then click “OK” to save and exit.
- Alternately, users can also edit the site by right clicking the mouse on the server name in the Server List.

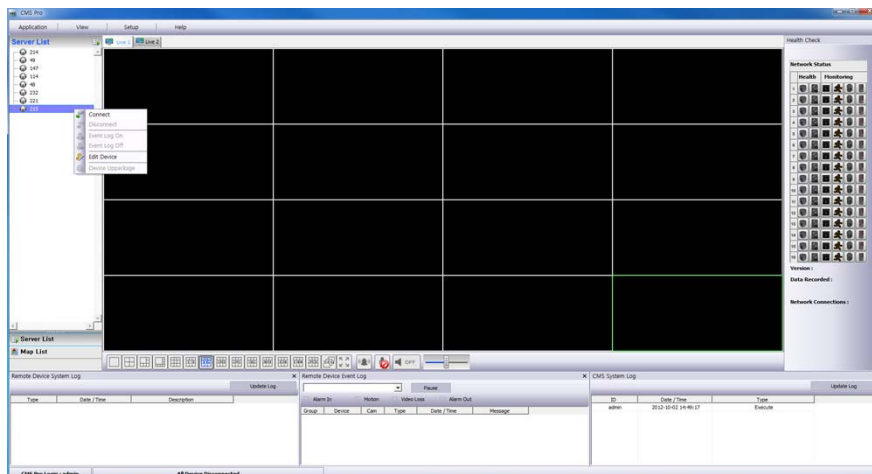

6.4.1.4 Remove Registered Site

- Select a site to delete on local setup window and click “Remove”
- The site will be removed on the local setup window.

6.4.2 Device Group Setup

- It is possible to make a group of multi-devices for user’s convenience.
 - Users are able to combine multiple devices as one group of connection for easy control.
 - Users are able to extract the cameras from registered DVRs to make own group of display.



6.4.2.1 New Grouping Setting

- Please click “New” to set up the Group Name, select Division (from 4 to 144), and type the Description.
- Select the site from the server list in the left-hand side of the window.
- Right mouse click and click “connect” on the site or double clicking the device will show the tree of cameras and here users can extract the channel they want.
- To add the channels into new group, drag & drop or double click on the camera.
- Users are able to continue to extract and add the channel by connecting other DVRs.
- Click “OK” to save and exit.
- Users are able to set the pop up display function.

6.4.2.2 Edit Group Setting

- Select a group to adjust on Group Setting window then click “Edit”
- Change the setting then click “OK” to save and exit.
- Right click on server list and select the “Edit Device”, and then following pop up window will show up. Users are able to set the “description” and Pop up Display

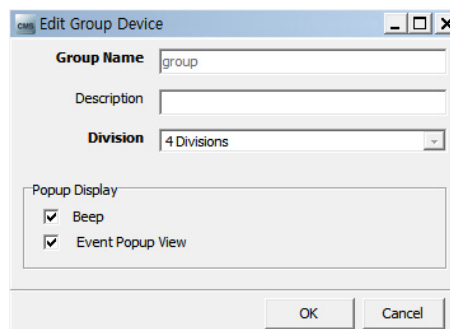

6.4.2.3 Remove Group Setting

- Select a group to delete on Group Setting window then click “remove”
- The group will be removed on the local setup window.

6.4.3 Local Setup - Environment

- This enables users to adjust the default setting for user's convenience.

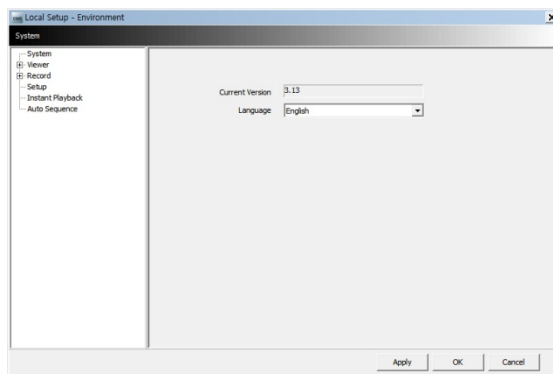

6.4.3.1 System

- Users are able to check the current version of the software.
- Users are able to select the language among English, Korean, Japanese, Russian and Turkish.

6.4.3.2 Viewer

- **Audio**
 - Users are able to control the Audio volume.
- **Video Display**

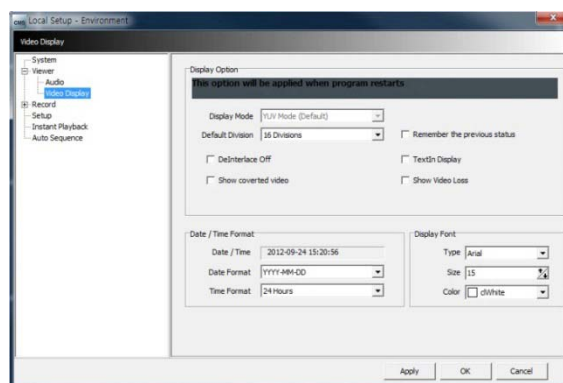

- Users can adjust and set the environment of the Display window.
- The Display option will be applied after program restarts and the contents are as below.
 - Display Mode: It shows the format of display and YUV Mode is the default and it is not adjustable.
 - Default Division: Users can select the number of division of display channels when the program initially displays the screen. (from 1 to 144 division)
 - Users are able to save division of display by marking the “Remember the pervious state” check box.
 - Deinterlace Off: This function changes playback display into Progressive Scan or Interlace Scan. Uncheck () Deinterlace Off, then frame will display as the Progressive Scan and shows the better picture quality.
 - Show converted video: if this box is checked, all the converted displays from DVR will show up.
 - Text-In display: Text data will be overlay on live and playback.
 - Show Video Loss: Popup window will appear, if video loss occurs on the connected DVR.

NOTE

If users check “Show converted video” box, this setting will be applied to playback as well.

NOTE

This option will be applied after program restarts.

- Date / Time format: Users can adjust and set the mode of date / time display in accordance with the location.
 - Date/Time: show current time.
 - Date Format: select the date format among YYYY-MM-DD/MM-DD-YYYY/DD-MM-YYYY.
 - Time Format: select the time format between 24Hours/ 12 Hours AM/PM.
- Display Font: Users can change the font of the name and display time of each channel.
 - Type: select the type of font between Arial and Courier.
 - Size: select the size of the font from 10 to 20 and the default is 15.
 - Color: select the color among 16 different colors.
- Text Detection
 - When registered text occurs from DVR, CMS notice it with pop-up windows.
 - Device: choose a device
 - Message: add message. (When added message occurs from DVR, window will pop up.)

6.4.3.3 Record

- Backup
 - Users can set the storage path of the image file of Screenshot or Zoom in Screenshot by typing the path or clicking the folder icon.
 - Save Directory (Screenshot): Select the save directory by designating the folder in the PC and save format between bmp and jpg.
 - Save Directory (Zoom in Screenshot): Select the save directory by designating the folder in the PC and save format between bmp and jpg.

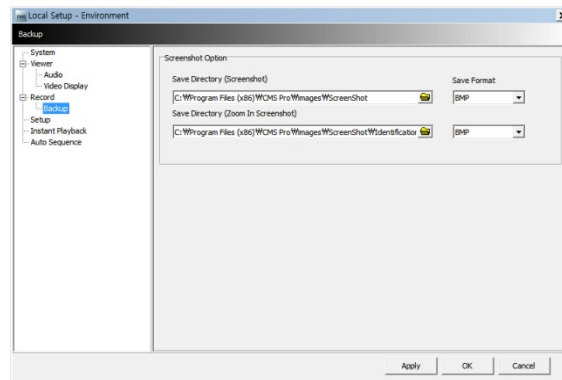

- Instant Recording
 - Users can set the storage path of the instant recording file by selecting HDD installed in PC.
 - Select Drive: Select PC's HDD where instant recording file will be saved from the drop down menu and click "Add". It will show Drive type, Free Space and Total Space of selected HDD.
 - Storage List: Added HDDs can be prioritized or deleted. Use Up and Down arrow to prioritize and "Delete" to remove HDD from the list.

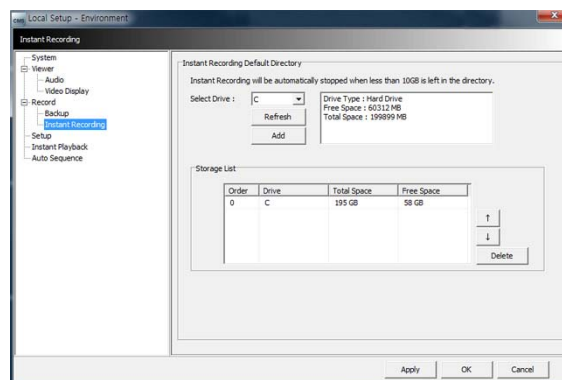

NOTE

Instant Recording will be automatically stopped when less than 10GB is left in the directory.

NOTE

Please refer to Chapter 6.7.2.9 for Instant Recording.

6.4.3.4 Setup

- Select Save Directory: Users can select the save directory of setup data or log data by designating the folder in the PC or other storage device and the change of the directory will be applied only after clicking “OK” button and exit.
- Select Data: Select data which users would like to save in the storage devices.
- Default setup: Initialize the setup to factory default. Click “OK” to exit the program.

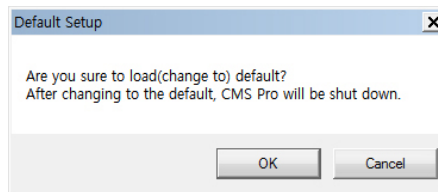
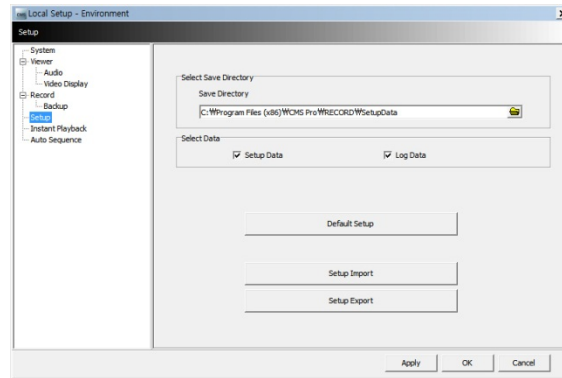

- Setup Import: Copy the Menu setup stored in USB memory stick (or PC HDD) into DVR. Please plug in the memory stick and then click (←) Import.
- Setup Export: Store the Menu setup of DVR in USB memory stick (or PC HDD). Please plug in the memory stick and then click (←) Export.
- Apply: Click the “Apply” button to apply the settings.

6.4.3.5 Instant Playback

- Instant Playback: Users are able to see the recorded data easily by using instant playback function.
- Set the time from which the recorded data is displayed.
- Instant Playback is displayed from the last preset time. (1, 3, 5, 10, 15, 30Min, 1, 3Hour, Default is 3Min)
- For example, if 5 Min is set as a playback period, then users are able to see the last 5 minute’s data from the current time.

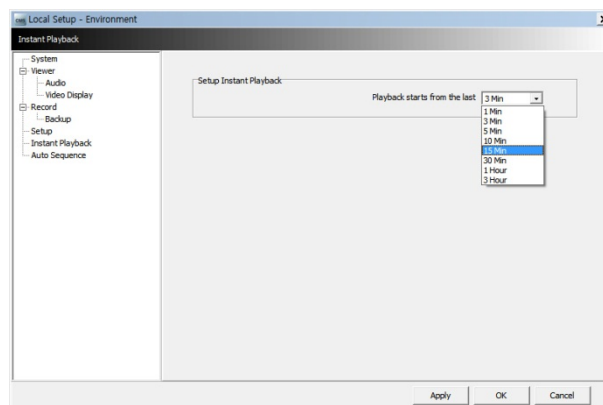

6.4.3.6 Auto Sequence

- Auto Sequence: Users are able to switching the camera view and setup the dwelling time between the different camera views.
- Set the dwelling time by clicking the  to increase and decrease the seconds. Note that it is only limited from 3~60seconds.

6.4.4 Local Setup - Account

- When more than 2 users need to access CMS Pro, multiple User Accounts and its authorization can be set in this menu.
- This setup is only permitted to Admin account holder..

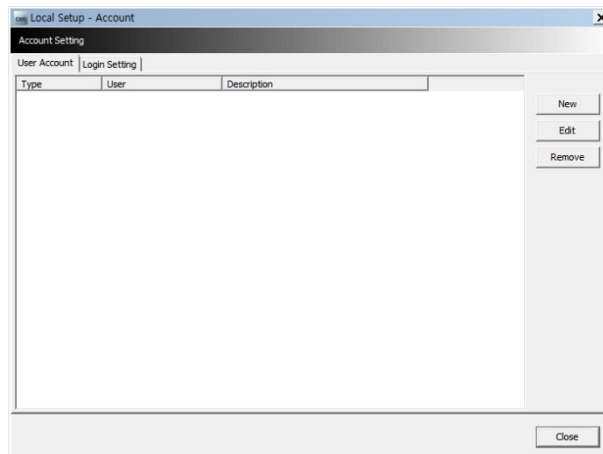

6.4.4.1 Add User Account

- Click “New” button and the following will appear.

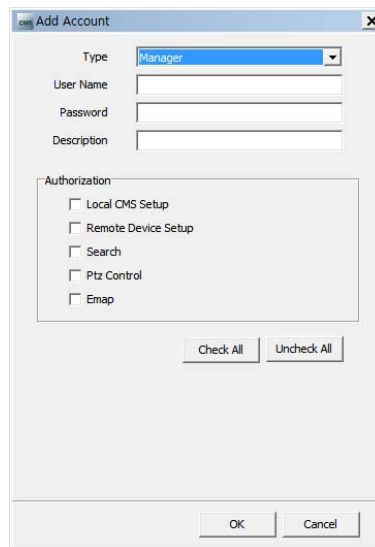

- Type: Select one of the two types of user account, Manager and User from the drop-down menu.
 - While Manager Account allows all of the authorization to be controlled, User Account is permitted to set only Search, PTZ control, and E-map functions.
- Create a User name and Password and then type Description of the account.
- Mark the authorization check boxes () to allow.
 - It is possible to give an authorization selectively to the individual user account.
 - “Check All” grants all the authorizations and “Uncheck All” deprives all the authorizations.
- Click “OK” to save and exit.

6.4.4.2 Edit User Account

- Users are able to adjust its Authorization and Password from EDIT button.

- All the procedures are same as Add User Account.

6.4.4.3 Remove User Account

- Users are able to remove the existing account.
- Select an account to delete then click “REMOVE” button.

6.4.4.4 Login Setting

- This function protects any activities of all Manager/User accounts by asking ID and Password prior to the fulfillments.
- Select the activities from the list () and click “Apply” to save.

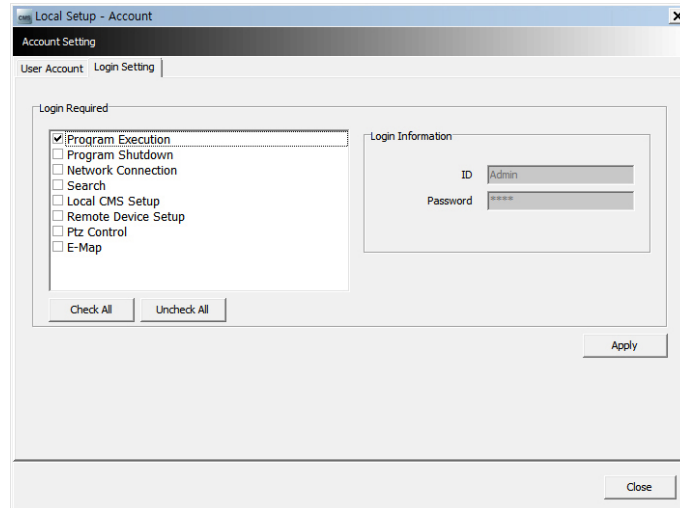

6.4.5 Local Setup – E-map

- Users are able to create various E-maps and it enables monitoring both Live and Playback screen.

6.4.5.1 Registering a New E-map



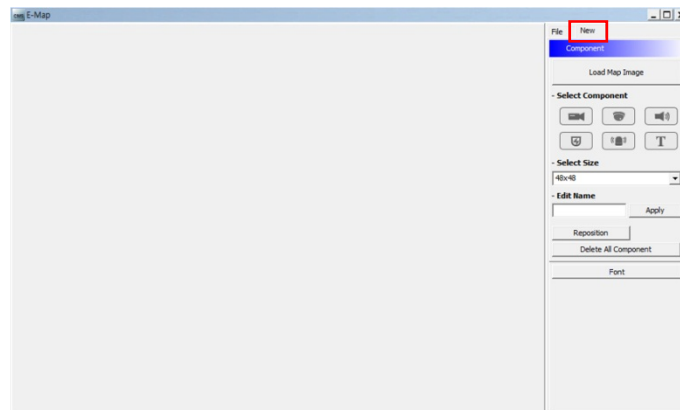



- Click “New” Tab to set up the E-Map.









- In order to load an image of the map, click “Load Map Image” that users would like to use as an E-Map.
- Users should select the image format between BMP and JPG.



• Place the icon of cameras, audios and alarms on the map. Each icon's detail is as below.

-  Box Camera. Generally indicates as Outdoor camera.
-  Dome Camera. Generally indicates as Indoor camera.
-  Users can hear the audio in the site by clicking the icon after setting the E-map.
-  The icon will be light on when the alarm in is activated.
-  If users click the icon, the light is on the icon and the alarm equipment such as siren and buzzer will be activated in the site.
-  Users are able to put description in the map using the Text Box.

• Select component

-  ,  ,  ,  ,  ,  Click the icon you want(then the icon turns to orange color) and click again on the place you'd like to locate on the loaded image.
- Users can rotate the icon to the direction that they want and move to other places by dragging.

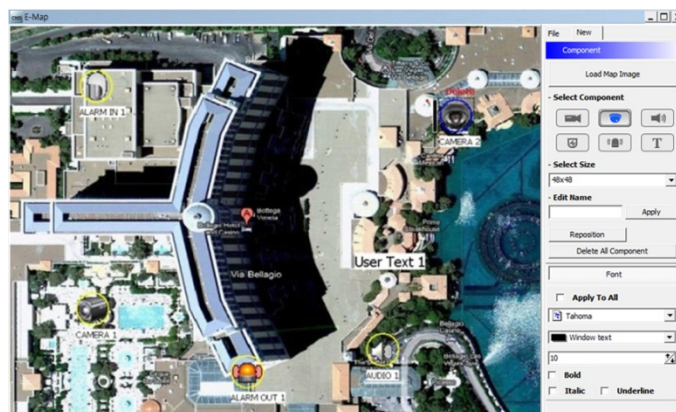

- Select Size: Size of the icon varies from 24*24, 32*32 to 48*48.
- Edit Name: Type the name of the icon and click the "Apply" to change the name.
- Reposition: The icons which are set up on the map can be repositioned into the right place even if the map size is changed (enlarged/reduced).
- Delete All Components: By clicking this button, users can delete all the components in the map at once.
- Font: Change the font of the text of the icon.
 - Click "font", then submenu will appear.
 - Users can select the font style, color, size, and other effects.
 - Check "Apply to All" to apply the change to all the components.



- Click “File” Tab to continue to set up the E-map.
- Type a name of E-map when you finish map setting in “New” menu.
- Click “new” to add a new location in Location list. If the other location is already saved, then select the location from the list.
- Select type among Outdoor, Floor, and Room.
 - Users can set up the hierarchical E-map in their taste.
 - For example, after setting up the floor map, room maps are added under the floor map.
- DVR Name: Select the specific DVR from the list to connect E-map.
- Users are able to check the E-map and its hierarchical structure from the “Registered E-map list”.
 - Here, users are able to load the map, delete the map and show map viewer by clicking mouse right button on the map list.



- Click “Save” to save and exit.



6.4.6 Remote Device Setup

- Select one among the connected devices and click “OK”.
- Then the setup window appears same as the one in the DVR.

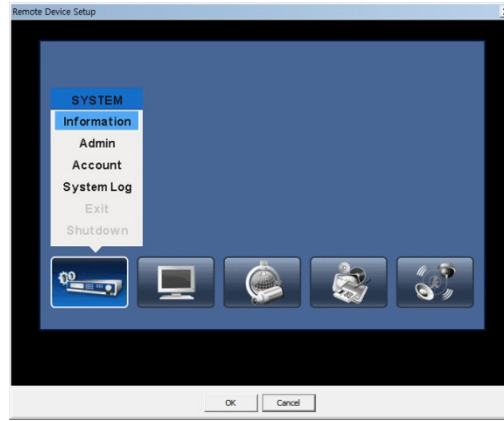
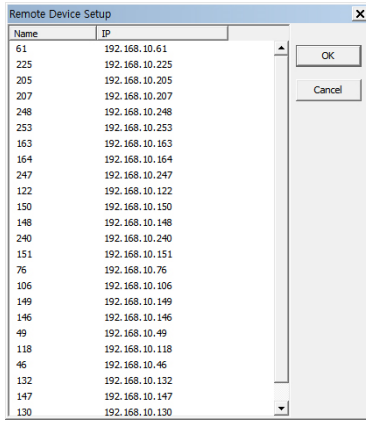

- Click “OK” to save and exit

NOTE

Some settings cannot be modified remotely.

6.4.7 Change Password

- Users are able to change the password of the ID.
 - Password: input the current password.
 - New Password: input the new password.
 - Confirm Password: confirm the new password.

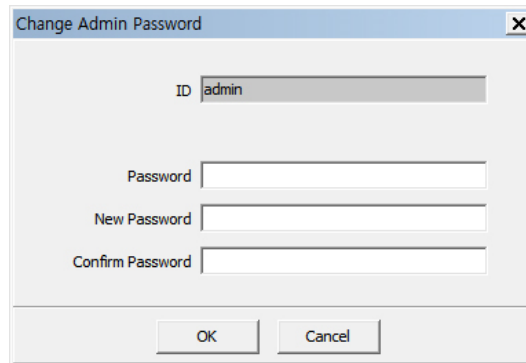

NOTE

User “ID” cannot be modified.

6.4.8 Help

6.4.8.1 About

- The version of CMS Pro can be checked here.

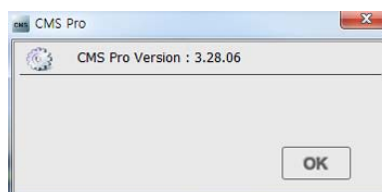

6.5 View

- The viewer of this program is composed with 5 types of different panes.
 - Server List, Remote Device System Log, Remote Device Event Log, CMS System Log and Health Check.

6.5.1 Server List

- When the device is registered, then it is displayed on the Server List.
- If uncheck “Visible” in the server list menu, then the list will not be shown.
- Check “Left” or “Right” to move the list to left or right side of the screen.

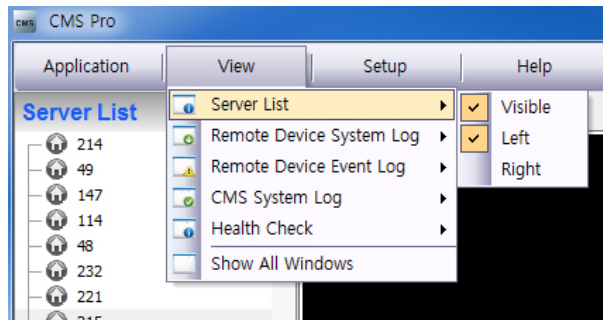

6.5.2 Remote Device System Log

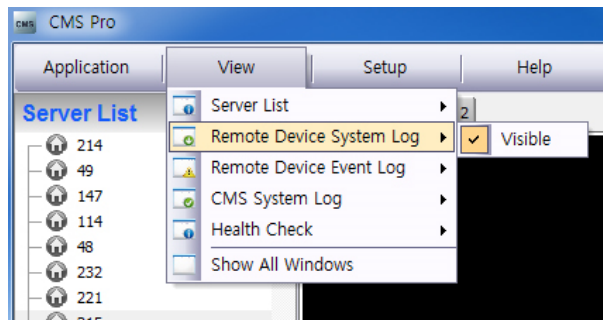

Remote Device System Log [215]

Update Log

Type	Date / Time	Description
System	2012-10-02 15:27:27	network connected
System	2012-10-02 15:29:21	Network disconnected
System	2012-10-02 15:29:38	Network connected
System	2012-10-02 15:47:12	Before time adjusted.
System	2012-10-02 15:47:12	After time adjusted.
System	2012-10-02 15:47:12	NTP Sync : Success !
System	2012-10-02 16:06:16	Network disconnected
System	2012-10-02 16:07:27	Network connected

- User can check the system log of the device in this menu.
- Type, Date/Time/Description can be checked.
- The contents in the parenthesis show the name of the device. Ex) [Demo]
- Check “Visible” in the Remote Device System Log menu to see the menu or uncheck “Visible” in order not to see the menu.
- Click the “Update Log” button to update the log.

6.5.3 Remote Device Event Log

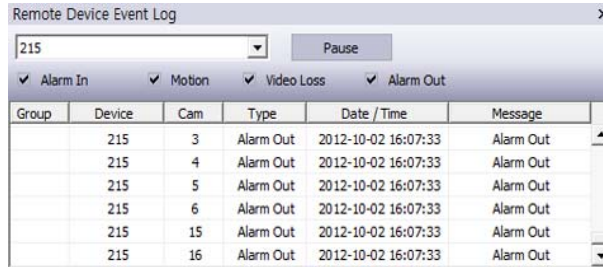
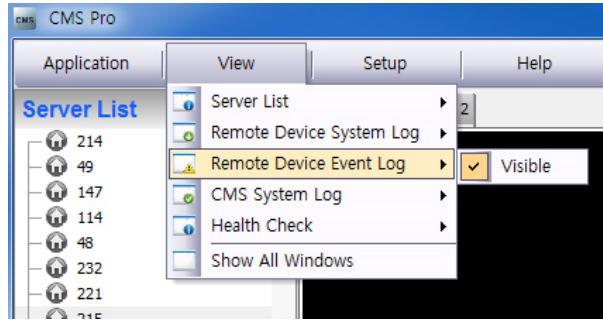

- Check “Visible” in the Remote Device Event Log menu to see the menu or uncheck “Visible” in order not to see the menu.
- Users can select the registered device from the drop down box menu.
- Alarm In / Motion / Video Loss / Alarm Out can be selected separately as Event. (More than 2 events can be selected at the same time.)
- And by clicking “Event log On/Off” after right mouse click on the device in the server list, users can check/uncheck all the events at once.
- When the event operates, the event log will show the information of the event in the list.
- If click the pause button in the menu, then event log will be stopped.
- Click the resume button to resume the system event log. (The log data will be lost during the pause.)

NOTE

The Remote Device Event Log is on when the “pause” is shown while the log is stopped when the “resume” is shown in the menu.

- Double click the detected “Alarm In” or “Motion” event in the remote device event log to check the video of the event.

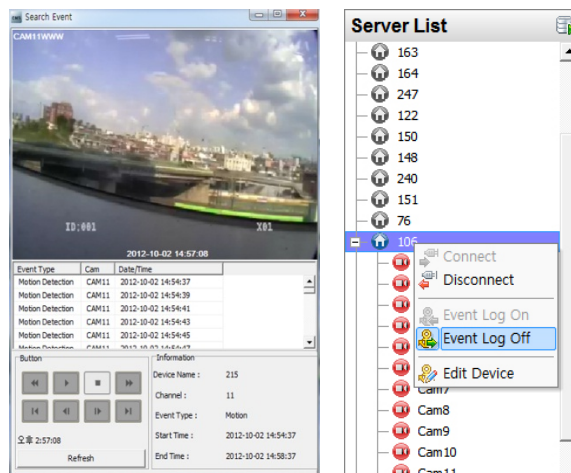

- Click the “Refresh” button to refresh the data.
- Click the right mouse button on the registered device to on/off Event Log in the Server List.
- If user selects “Event Log Off”, all event logs will be unchecked on Remote Device Event Log panel.

6.5.4 CMS System Log

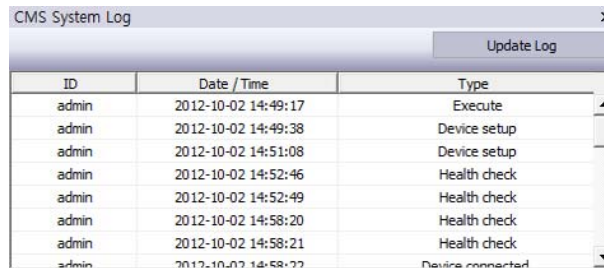
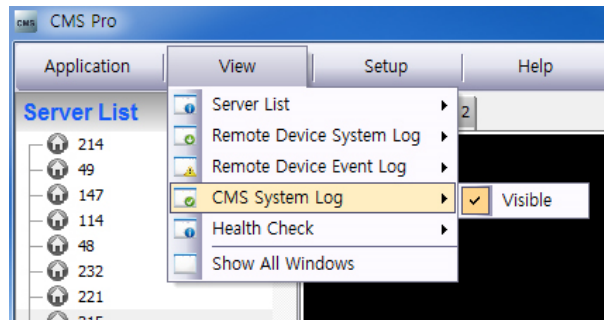

- This is the log menu where users can check the log information of the CMS program.
- Check “Visible” in the CMS System Log menu to see the menu or uncheck “Visible” in order not to see the menu.
- Click the “Update Log” button to update the log.
- Users can classify the Manager and User by checking the ID and get the information of connect/disconnect and shutdown of the user.



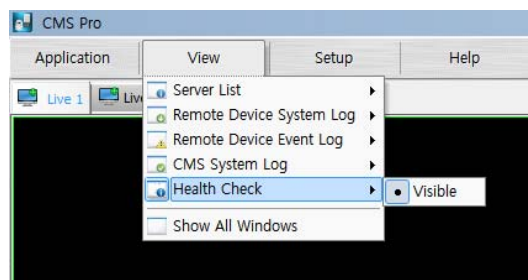
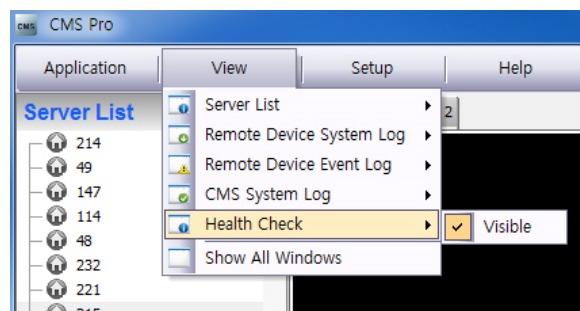

6.5.5 Health Check

- This is the menu where users can easily check the overall status of the device.











- Check “Visible” in the Health Check to see the menu or uncheck “Visible” in order not to see the menu.
- Left mouse click on the device in the server list to see the information of health check.
- HDD Status

-  HDD is not connected and cannot be added.
-  HDD is connected.
-  HDD is not connected currently but can be added.
-  An error occurred in HDD.



- Camera Status

-  Camera is in covert mode.
-  Camera is connected.
-  Camera is not connected currently but can be added.
-  Camera is not connected and cannot be added.

- Recording Data Status

-  The channel is not being recorded because it's not supported.
-  The channel is being recorded.
-  The channel is not being recorded currently but can be recorded later.

- Motion Status

-  Motion is not activated and supported.
-  Motion is being activated.
-  Motion cannot be activated but can be activated later.

- Alarm In Status

-  Alarm In is not activated and cannot be added.

-  Alarm In is being activated.
-  Alarm In is not activated currently but can be added later.
- Alarm Out Status
 -  Alarm Out is not activated and cannot be added.
 -  Alarm Out is being activated.
 -  Alarm Out is not being activated but can be added later.
- Relay Out Status
 -  Relay Out is not activated and cannot be added.
 -  Relay Out is being activated.
 -  Relay Out is not being activated but can be added later.

6.5.6 Show All Windows

- This function will make visible all the invisible window panes.

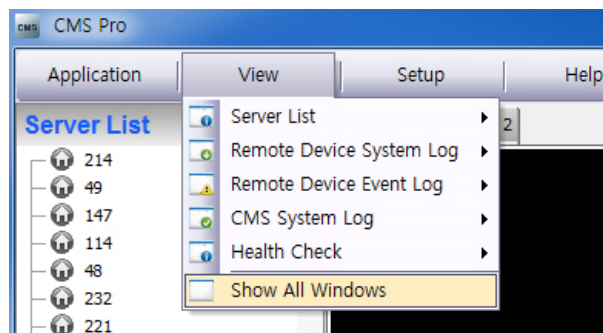

6.6 Application

6.6.1 Search

- There are five different types of search menu; Timebar, Event, POS/ATM, Thumbnail and Smart Search
- The detailed information and directions is described in chapter 8.

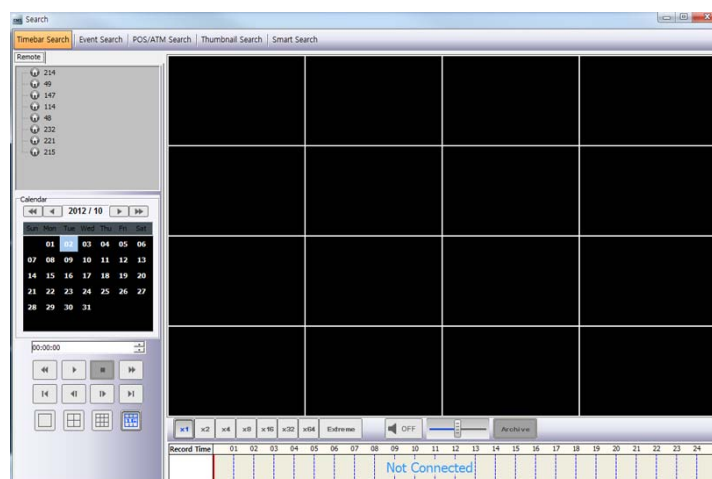

6.6.2 Exit

- If users wish to exit the program, then click the “Exit” in the Application menu.

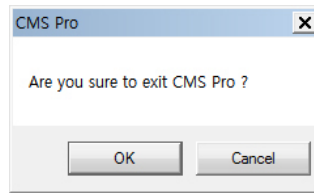

6.7 Live (Live Video Monitoring System)

6.7.1 Overview

- This program is to display live video from multiple channels in customized screen format.
- The program is based on user friendly interface. Users may configure the entire program and open or close the panes and screens in the program.
- The information of the device can be checked and monitored in real time.
- The overall information of recording/live view can be checked.
- ‘Login Display’ pane is to display the current user ID, authority group, data and time information.
- Dual, Triple monitor can be available and the quadruple monitor can be available by using splitter.
- Two live panes. 256 channels for each pane.

6.7.2 Live Monitor Menu

- The following functions are operated when the right mouse button is clicked on the screen.

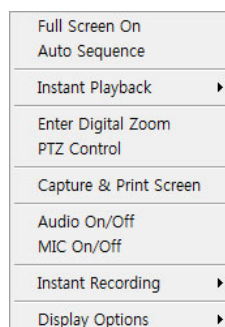
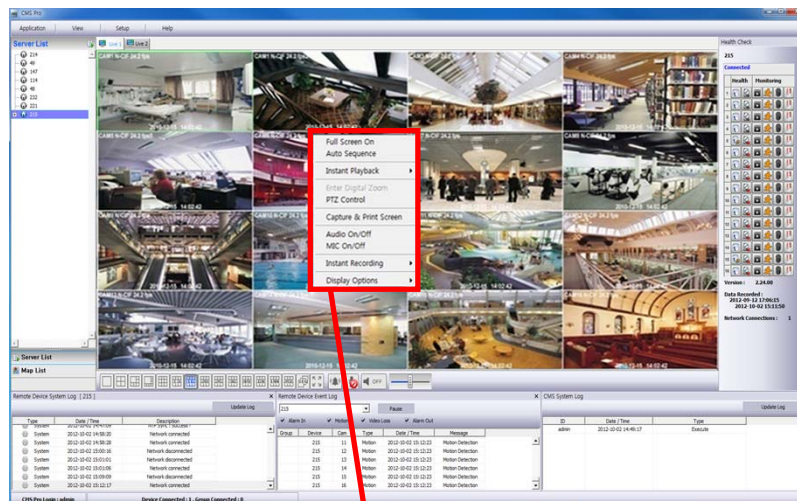

6.7.2.1 Full Screen On

- Click “Full Screen On” to make selected channel into a full screen.
- Click “Full Screen Off” to exit the full screen.



6.7.2.2 Auto Sequence

- Users are able to set the auto sequence.
- When user set the “Auto Sequence” display mode, screen will change to 1 channel display mode and channel will be changed by user’s setup. For more information Please refer chapter 1.4.3.6.

6.7.2.3 Instant Playback

- Instant playback is available in both Live1 and Live2 pane, but screen capture is available in either live1 or live2.

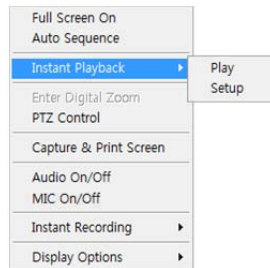

- After right mouse click, move the mouse cursor to “Instant Playback”. Then, play and setup menu will appear.
 - Play: The recorded video of the pre-setup time will be displayed in the playback viewer.
 - Setup: The time of instant playback can be setup in this menu, from 1minute to 3hours. (1Min, 3Min, 5Min, 10Min, 15Min, 30Min, 1Hour, 3Hour. The default time is 3Min.)

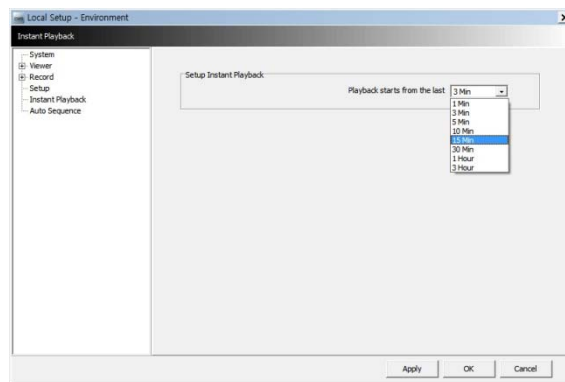

NOTE

Users can also set up the Instant playback in the menu, “Local Setup – Environment”.

- The image capture is supported in the instant playback viewer by clicking right mouse button on “Capture Image.”

NOTE

For more detailed information of captured image, please refer to the Chapter 6.7.2.6 “Screen capture & Image”.

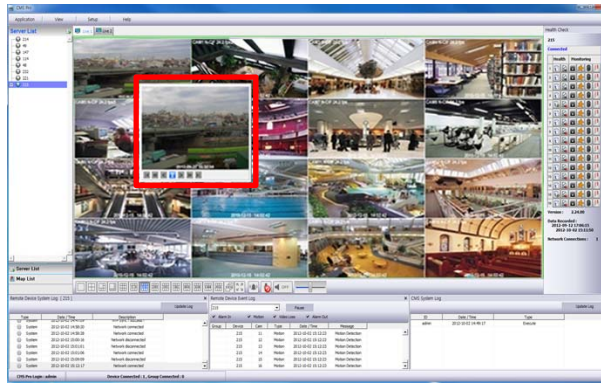

6.7.2.4 Digital Zoom

- To use digital Zoom, please make the display as 1CH.
- Right click on the mouse and select Enter Digital Zoom.

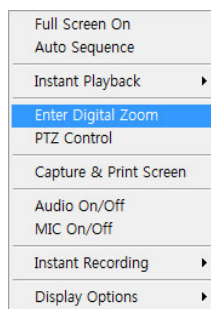

- To Zoom in and out, please use the display function at the corner of the channel Display or click and drag the area wish to zoom in.
- Zoom area can be moved by dragging the position from the corner box.

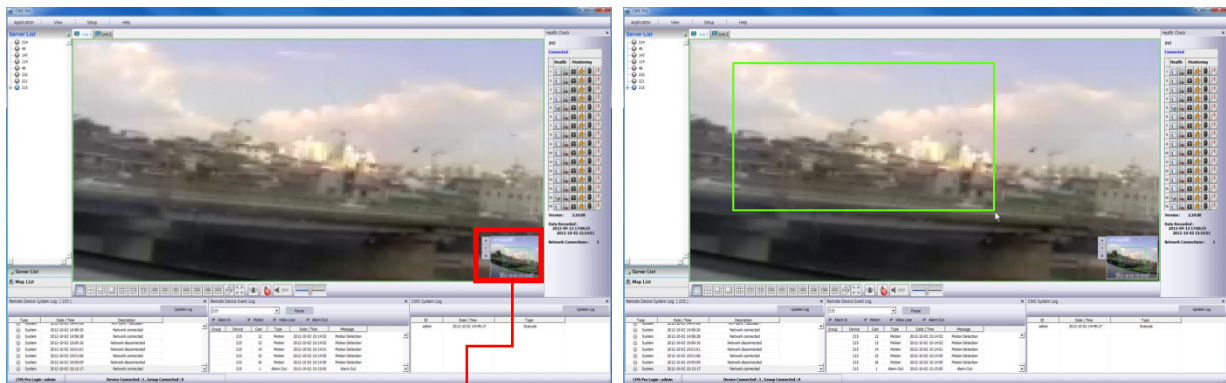

Zoom in / out function



Zoom In



Zoom Out



Zoom Area: The Screen will revert to x4 digital zoom screen.

- After right mouse click on the channel that PTZ camera is connected, select “PTZ control”.



NOTE

Digital Zoom function can be only used when the display is adjusted as 1 CH.
 The digital zoom function is able to zooming approximately x32.

6.7.2.5 PTZ Control

- After right mouse click on the channel that PTZ camera is connected, select “PTZ control”.
- Users can designate the certain area and set the name by using “Preset” function.
- Up to 255 presets can be designated.



• Zoom



• Focus



• Iris



• Preset



– Drop down menu: Select a preset number which is set in the camera.

– Preset Name: Save the selected preset name.

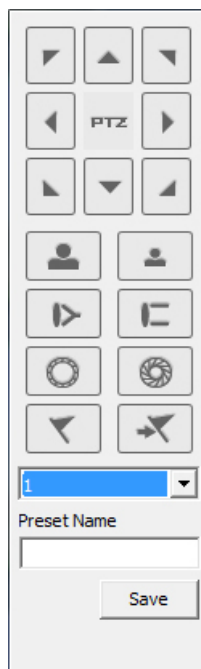

6.7.2.6 Screen Capture & Print

- After right mouse click, select “Capture & Print Screen”
- The brightness, contrast and saturation can be adjusted to store in users’ taste and can be printed directly.

NOTE

Image adjustment is only possible on the last captured image.

- Users are able to save the captured image by clicking “Save as Image”.
- Create a name of captured image and select the image type between BMP and JPG
- Users are able to choose the folder in which they wish to store the image.

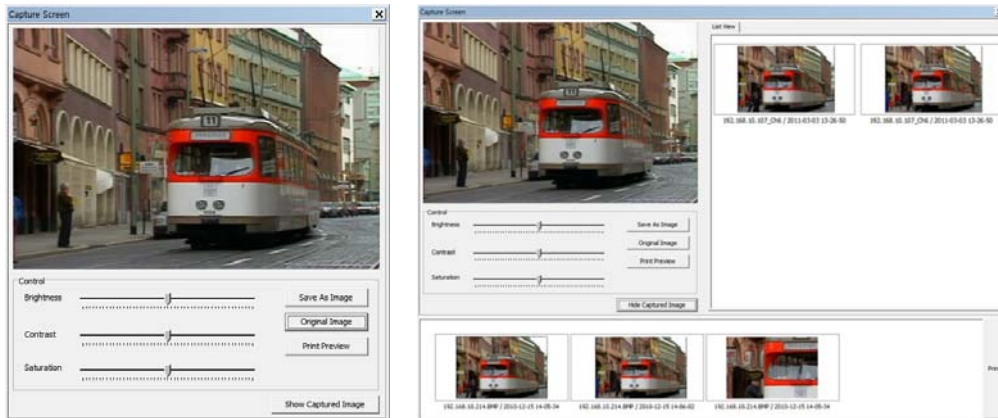

- Click “Show Captured Image” to show the captured images.
- Users can even **recapture** the part of the captured image by dragging the place users want.
- Click “Print” button to print all the captured images at once.
- If users want to print the image one by one, then click the “Print Preview” button.
 - Users can type the title in the text box on the top
 - Add Text: Users can add the description in the text box on the bottom.
 - Delete Text: Delete the last written text at once.
 - Delete all: Delete the all the text in the captured image.

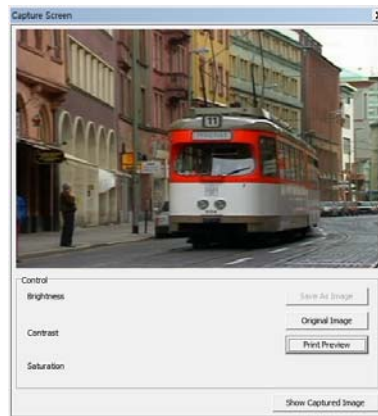

- Click “Hide Captured Image” to hide the captured images.

6.7.2.7 Audio On/Off

- Click right mouse button to on/off audio in the channel.
- Audio On/Off function is applied to only one channel out of all connected channels.
- Once audio is on “OFF” will be changed to show connected audio channel. “CH10”

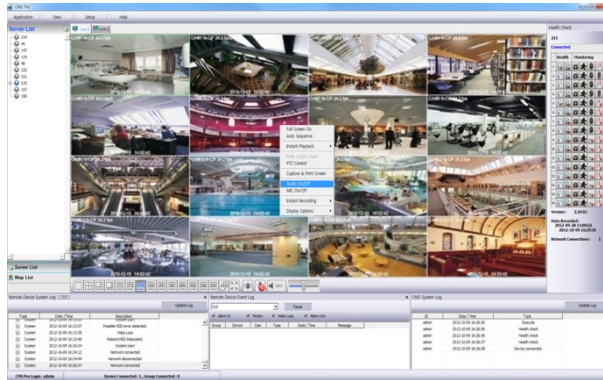

6.7.2.8 MIC On/Off

- Click right mouse button to on/off Mike.
- Users can deliver the audio through the speaker connected to DVR by sending the audio from PC where CMS Pro is activated.

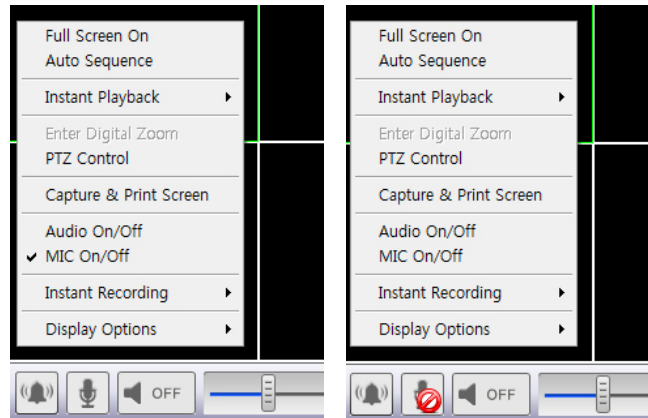

6.7.2.9 Instant Recording

- Click right mouse button to activate the Instant Recording.
- In the Instant Recording, there are three choices of start recording, setup and open folder.
- Click Start Recording to record the particular channel that user wants.



- If user wants to have password for the archiving file, please click 'Use Password' and type the password that users want to use.



- If users click 'OK', it will start recording of particular chosen channel.
- When users want to view the archived file, please choose "Open Folder"

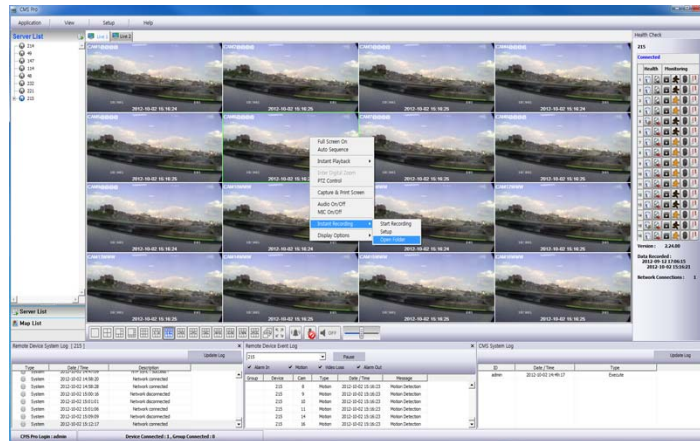

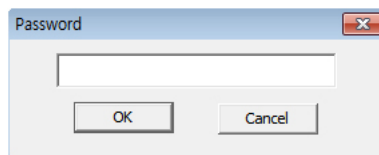

- It will open the saved directory of the file.
- When users double click the created file, password window will pop –up.
- Please type the previous password that users entered in Password setup

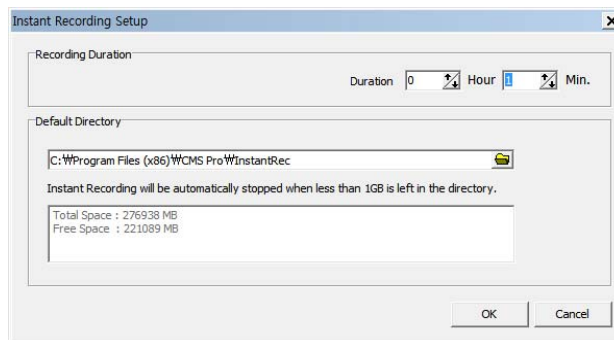

- When Users want to "stop recording", click right mouse again and select Instant Recording and choose "stop recording".
- Choose "Setup" in the Instant Recording to set up the recording duration and default directory.



- In the recording duration, users can setup the hours and minutes by clicking the "upside down arrows" 
- In the Default Directory, users can choose the directory to save the recorded file by clicking the 
- "Open folder" will allow users to select the recorded files and play them.

6.7.2.10 Display Option

- Users can set up the display of camera name and time in “Display Option”.
- After right mouse click, check the “Show Camera Name” to display the camera name or uncheck the menu to hide it.
- After right mouse click, check the “Show Time” to display time or uncheck the menu to hide it.

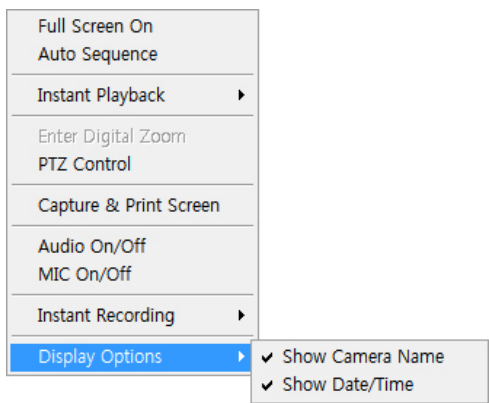

6.7.3 Screen Layout Control

- Since every menu can be relocated by drag and drop, it is easy to customize the lay out in users' taste.

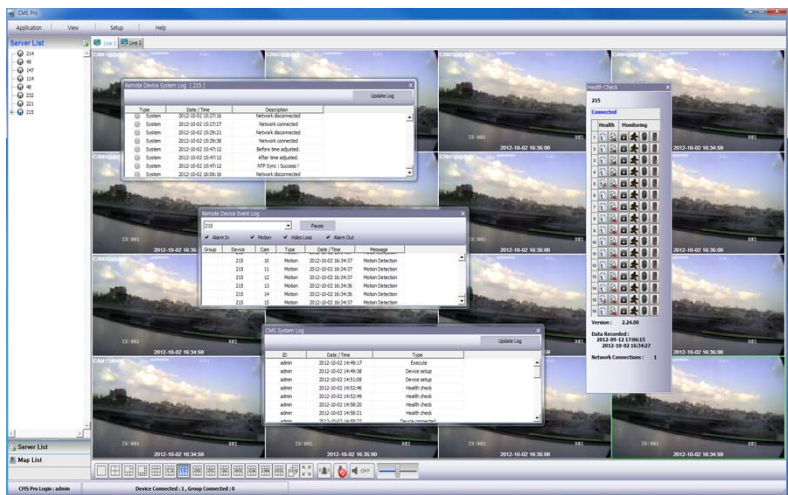

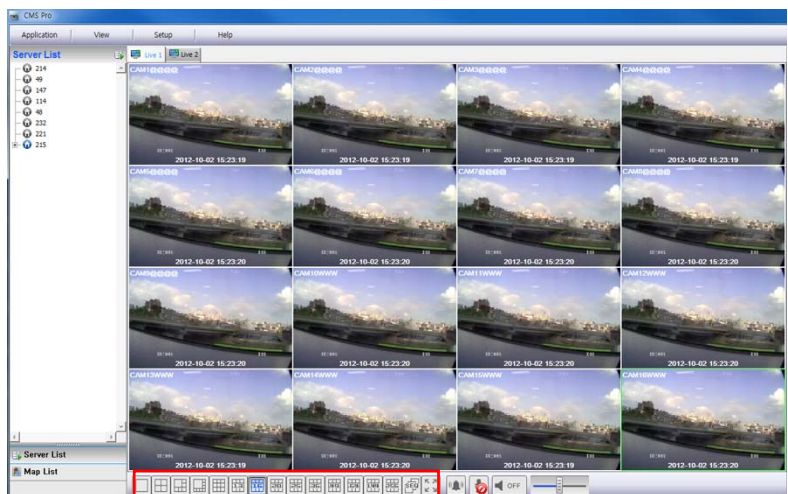

6.7.4 Change Division Display

- From a single full screen to 256 channels, various combination of channel display is provided by clicking the icon at the bottom of the screen.

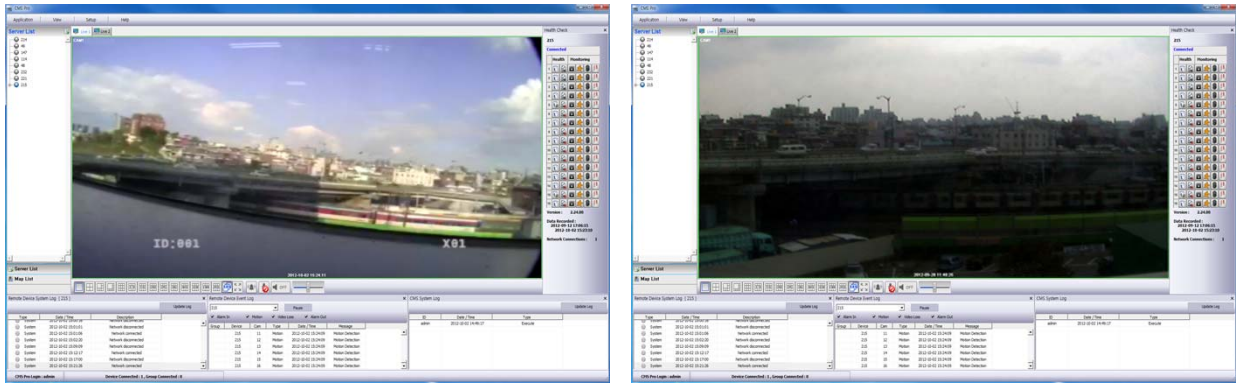

6.7.5 Sequencing



- Click the  to switch the channel according to setup made in auto sequence in Local setup – Environment.
- It is only supported one channel

6.7.6 Audio Volume Control

- Users can control the audio volume using the bar controller at the bottom of the screen.

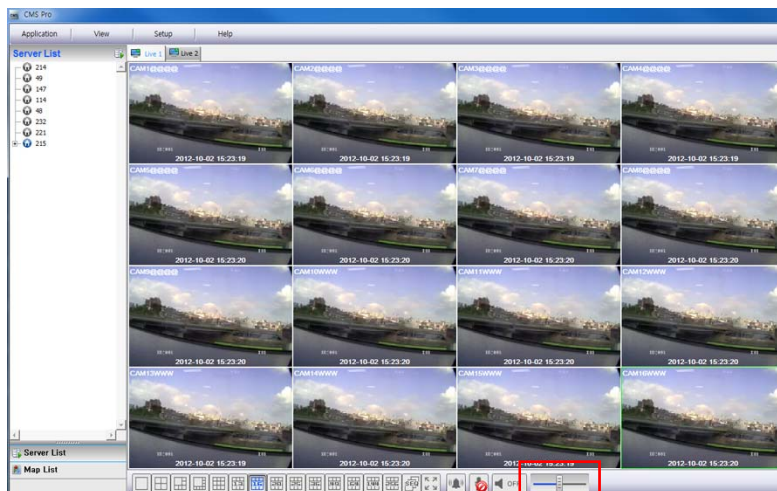

6.8 Search

6.8.1 Overview

- There are five different types of search function and users are able to search the recorded data by using a suitable search function of the five in accordance with their purpose.

NOTE

Search window cannot be closed during playback, also cannot be changed window size. Please close the window after stop. Playback more than 2 channels at the same time is available only in time bar search.

6.8.2 Time Bar Search

- First of all, open a search window by clicking the “search” in the application menu.
- Click the “connect” after right mouse clicking on the device list.
- Once it is connected to the program, date, month and year of the recorded data is highlighted in the calendar.
- The text box in the left-bottom side of the window shows the time of playback video.
- The recorded data of a day is displayed as a colored bar on the time line at the bottom.
- Users can easily search the recorded data by clicking on the time in the time bar.

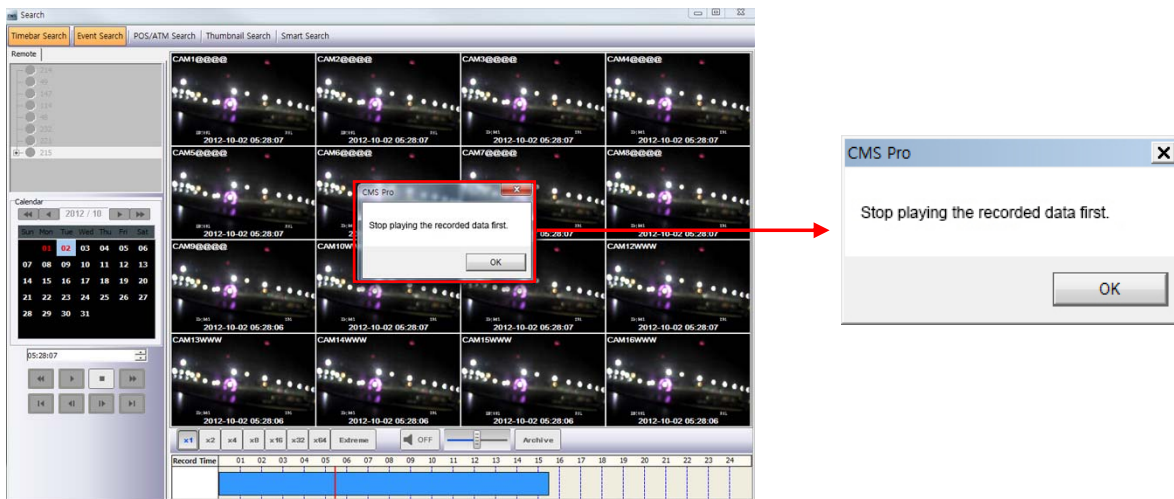

NOTE

Users can change the speed of rewind and fast forward from x1 to Extreme. It is speed of REW and FF, not the one of play.

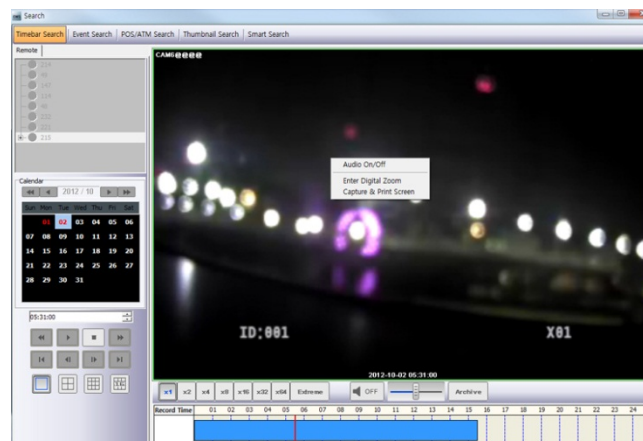

- Users can use Right click to access Audio On/Off, Digital Zoom and Capture and Print Screen.
 - Audio On/Off: User can enable audio function. If Audio is connected Audio Status will change.
 - Enter Digital Zoom: User can use Digital zoom. Please refer 1.7.2.4 Digital Zoom.

- Capture and Print Screen: User can capture image. Please refer 1.7.2.6 Screen Capture and Image.

NOTE

Audio and Digital Zoom are supported only in 1CH display mode.

- In the playback menu, users are able to decide to search the data from the beginning of the day or from the cursor position.
- Or just simply click on the time line users want, and then click “▶” button on the left.

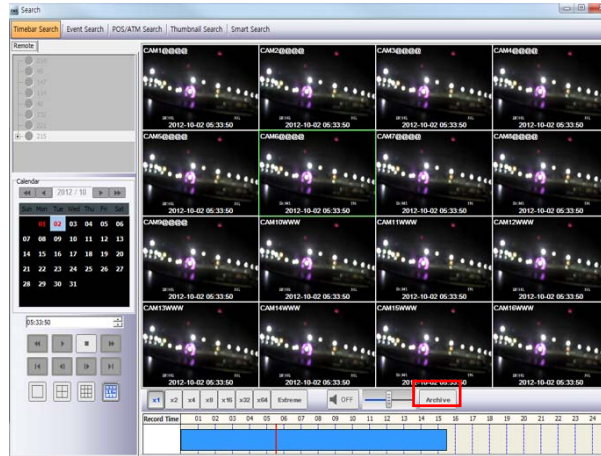

- Click “Archive” button to set up the Archive.
- In this menu, it is available to set the start time, end time, file name, the location of the file, password and the cameras to store.
- After finishing setup, click “Start EXE Backup”.

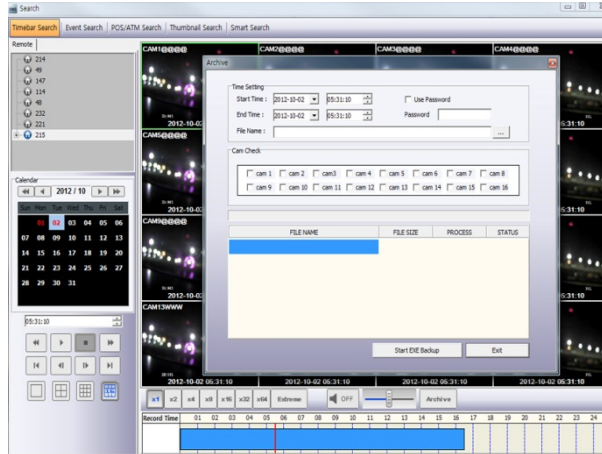

NOTE

Archiving function is available only in time bar search.

6.8.3 Event Search

- Click the “connect” after right mouse clicking on the device and select the “Event Search”.
- Check the event type which users wish to search among “Emergency”, “Alarm” and “Motion”.
- (Users can select more than 2 event types at the same time)
- Select a camera to search. (Only 1 camera can be selected in event search.)
- Set up the start time and end time in Date/Time setting and click “Search” button.

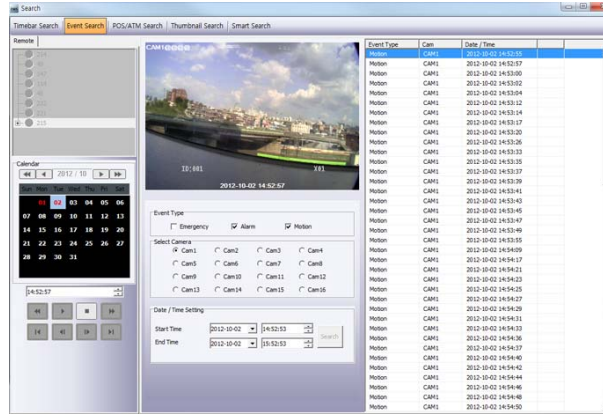

- To check the event that is detected on the right side of the search window, double click the event that users want.

6.8.4 POS/ATM Search

- Click the “connect” after right mouse clicking on the device and select the “POS/ATM Search”.
- Type the text that users want to find in the “POS / ATM” text box.
- Select a camera to search. (Only 1 camera can be selected in this search.)
- Set up the start time and end time in Date/Time setting and click “Search” button.
- The detected text will be displayed in the right side of the search window.
- Double click or click on the event(Text In) and click the play button “▶” to check the playback..
- Text Option – Display unit is transaction (Database)

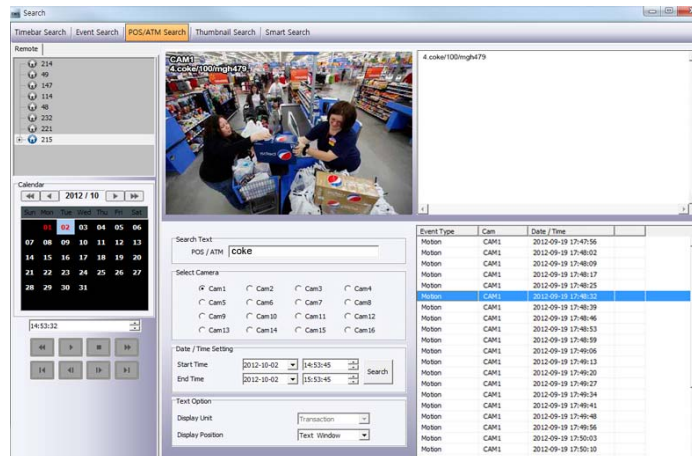

- Display Position – Users are able to select the display option of the playback.
 - Text Window: Only text will be displayed in the top right side of the search window during the playback.
 - Overlay: The text will be overlaid on the playback video.
 - Both: The text will be overlaid on the video and the text window as well.
 - Hide All: The text will not be displayed in both video and the text window.
- To check the event that is detected on the right side of the search window, double click the event that users want.

6.8.5 Thumbnail Search

- Click the “connect” after right mouse clicking on the device and select the “Thumbnail Search”.
- This search function provides the users with the certain number of snapshots of the recorded video of the selected camera.
- It is very convenient and efficient in the aspect that it can save the time to search the data that users want to find by checking the snapshot of every pre-set time.
- Users are able to select the duration of the playback in “Thumbnail Duration” from 1Min to 60Min. (1, 3, 5, 10, 20, 30 and 60Min)
- The number of “Max Capture Count” can be setup as 32, 64, 128 and 256.
- Like other search functions, set up the start time and end time in Date/Time setting and click “Search” button.
- Double click the founded snapshot to check and play the video.
- Click “Stop Search” to stop the search and check the video to the stop time.
- The video will be displayed in the “video display” panel at the bottom of the search window.
- Users can move the panel around the screen and adjust the size of the panel as users want.

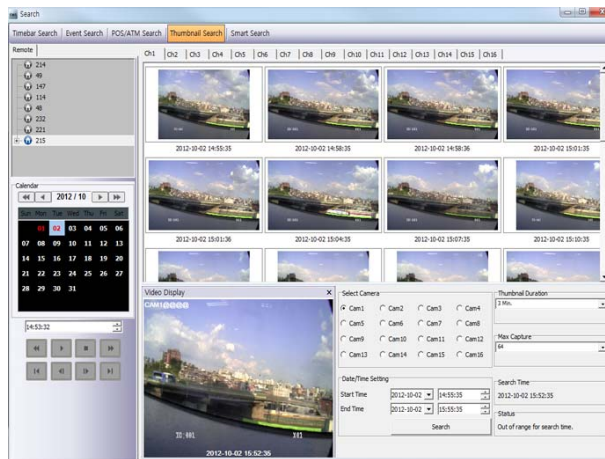

6.8.6 Smart Search

- Click the “connect” after right mouse clicking on the device and select the “Smart Search”.
- This search function provides the users with the smart search option.
- Users can select the area in an individual channel by dragging the certain area in “setting” menu. (More than 2 areas can be designated in the setting pane.)
- If the movement is detected in the area, it will automatically display the video clip in the search window.
- Users are able to select the one from the 3 types of sensitivity level; Super, High and Standard.

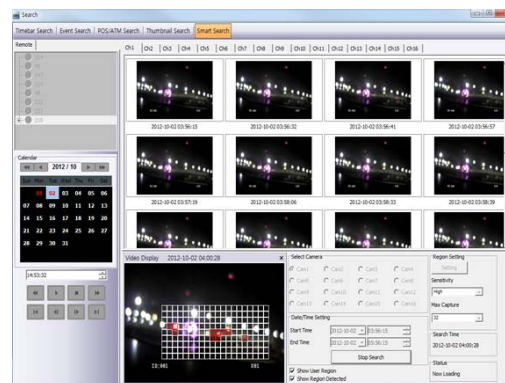
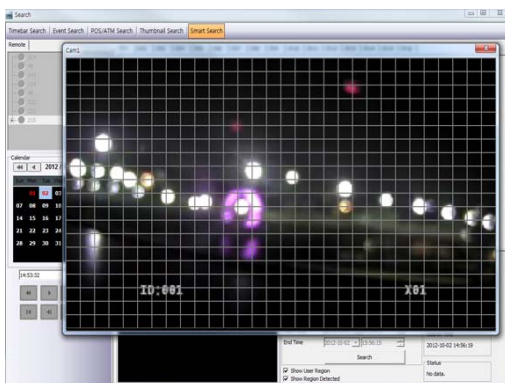

6.9 E-Map

6.9.1 Overview

- The 'Map Viewer' program is to display event signals over map images so that users may acknowledge event status with geographical information.
- Users may perceive event occurrence status with visual notifications on icons over the map image and audible notifications on speaker system of a PC. By clicking on the camera icons on the map, users may launch 'Instant Viewer' window.
- To utilize 'Map Viewer' properly, users should configure map before running 'Map Viewer' program.
(Please refer to Local setup – E-map in chapter 4.4)

6.9.2 Controls

- Users can load the Map Viewer which was set up "in Local Setup - E-Map" by clicking right mouse button on the map in the map list.
- Users can check the information of the device connected E-map in the right side of the Map viewer such as Device status, name, IP / Domain, the maximum number of Camera, Alarm in / out and Audio.

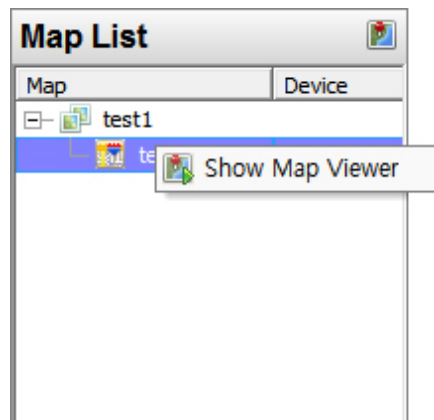

6.9.3 E-map Camera – Instant Playback

- Users are able to load the instant viewer by clicking the camera icon on the map, change the size of the video and move it around the screen.
- Full screen mode is available by clicking right mouse button and select "Full screen".
- Click audio icon to listen to the audio in the site where the audio input is connected.
- Click the alarm out icon to give the signal to the alarm equipment in the site such as siren or buzzer.

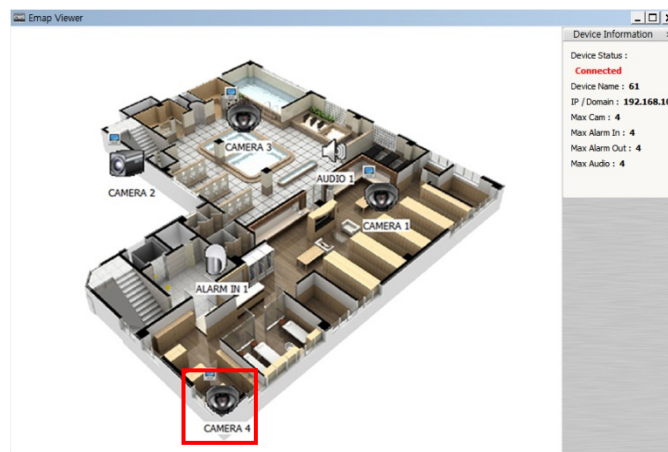



6.9.4 Alarm In/Out Control

- The Alarm In icon on the map will be light on when the Alarm In equipment like sensor or detector is activated in the site.
- If users click the Alarm Out icon, the light is on the icon and the alarm equipment such as siren and buzzer will be activated in the site.

6.9.5 Audio

- Users can hear the audio in the site by clicking the icon on the map.

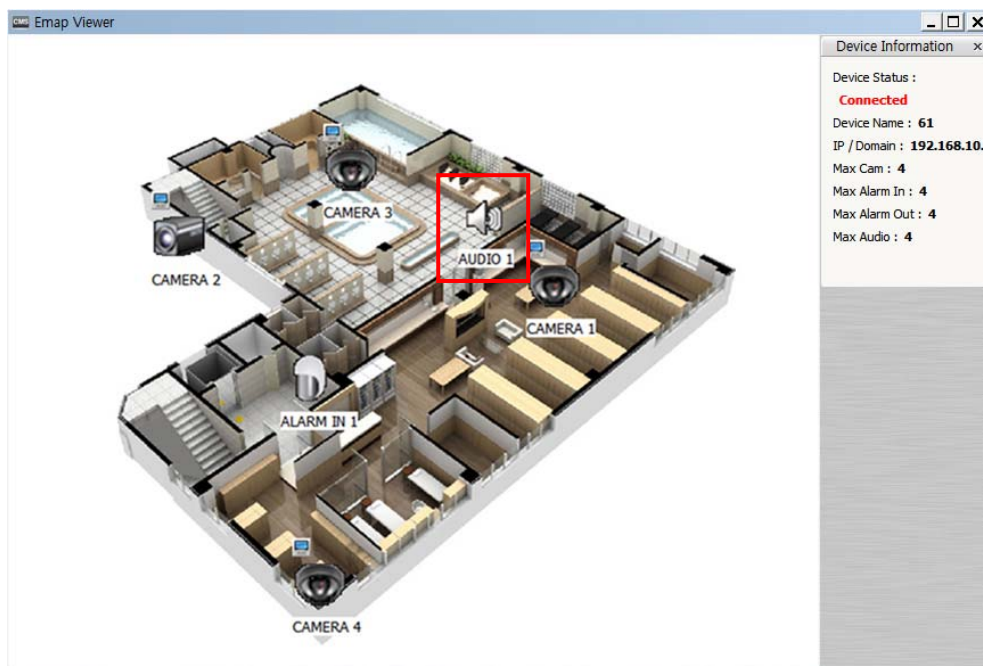

6.10 Uninstalling CMS Pro

- Please click the “Uninstall” file in the CMS Pro folder in the PC.

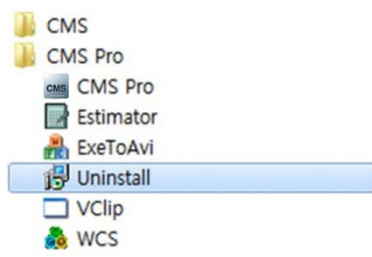

- Click the uninstall file and the following message box will pop up.
- Click “OK” to remove the program and its components.

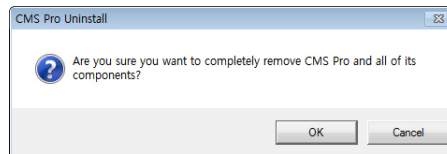

- If uninstall is complete successfully, the following message will pop up.

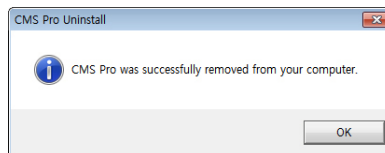

iCMS

User`s Manual



7. iCMS VIEWER

7.1 System Recommendations

	Recommended
CPU	Core 2 Duo 2.26GHz or higher
Main Memory	2GB or higher
Video Memory	512MB or higher
Display Resolution	1024 x 768 (with 32bit color) or higher
HDD Storage Space	30GB or higher
Network	100~1000 Mbps Fast Ethernet
Operating System	Mac OS 10.6.0 or higher

NOTE

It is recommended to connect Max. 16 HD-SDI (Full HD) cameras with CMS Pro.

WARNING

CONNECTING MORE THAN 16 HD-SDI (FULL HD) CAMERAS MAY RESULT IN MALFUNCTION OF THE SOFTWARE. TO CONNECT MORE THAN 16 HD-SDI (FULL HD) CAMERAS, PLEASE ENABLE DUAL STREAMING OPTION ON THE DVR.

7.2 Program Installation

- Please follow the program installation procedures below.
- Open the file 'iCMS.dmg'.

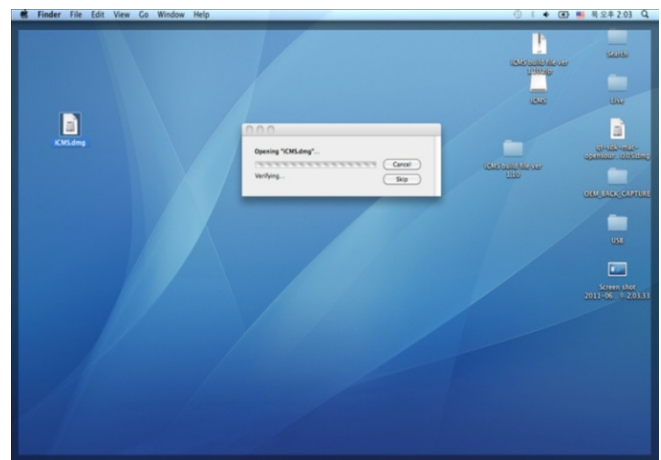
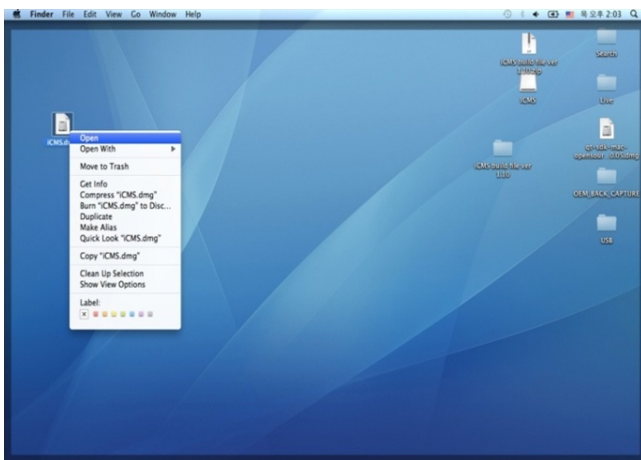

- Virtual driver will be installed (Driver name is "iCMS").

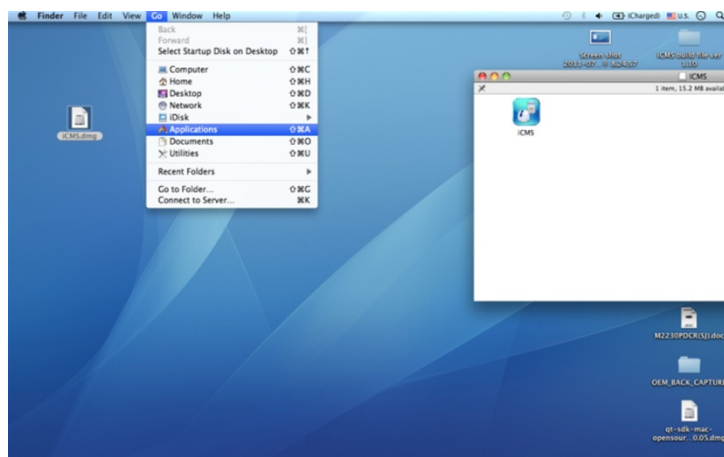

- In the virtual driver, users will find iCMS icon. Please move the iCMS icon to **'Application'** folder (**'Application'** folder is located in the **'Go'** Menu below).



7.3 Login

- After installation of the software, iCMS icon appears in **'Application'** folder.
- Please double click on the icon to execute the program.
- Select User Name by clicking upside down arrow and enter corresponding Password to login.



7.4 Watch Mode

7.4.1 Log-in Screen

- Please click 'Device manager' and the following screen will appear.

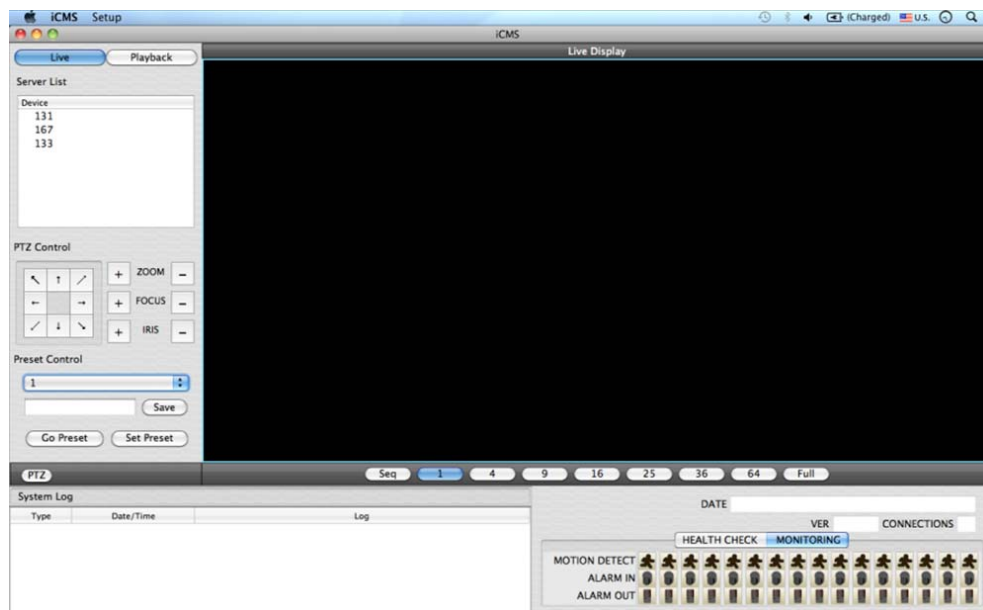

7.4.2 Local Setting

- Please click 'Setup' button on the top of the Toolbar and the following screen will appear.
- There are three types of setup such as Device Manager, Display Setup and Password Change.

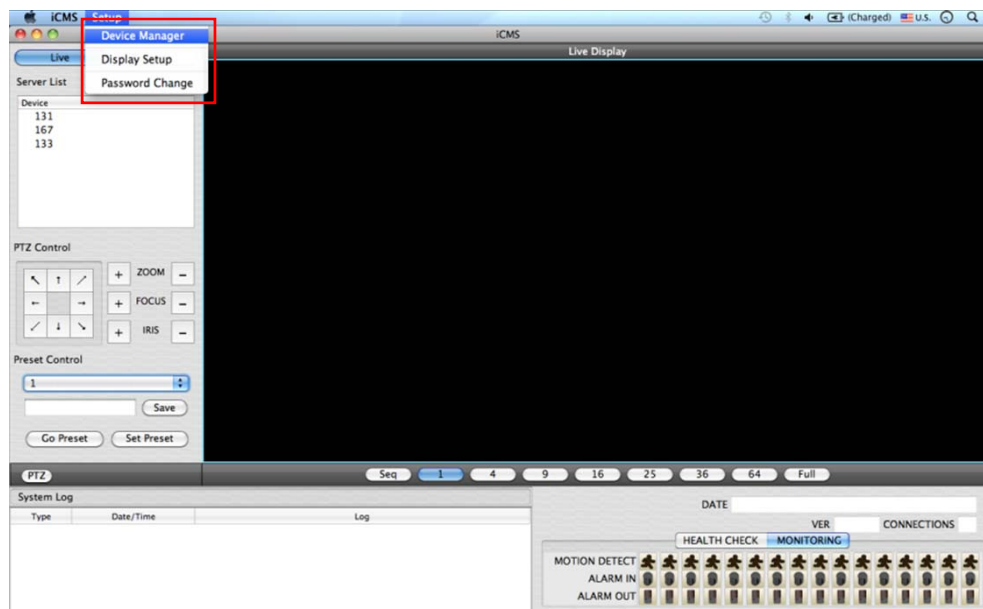

7.4.2.1 Display Manager

- Please click 'Device manager' and the following screen will appear.

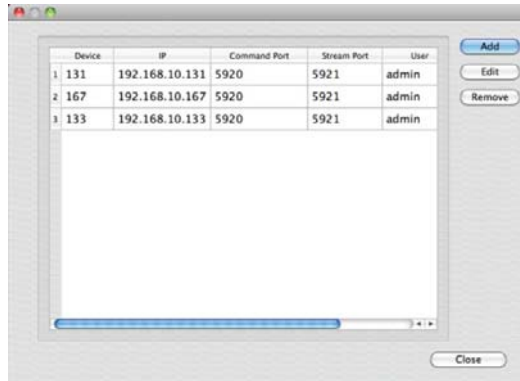

- Users will see the already existing DVRs on the list, if there is any added DVR previously.
- Please click 'Add' to add new device.



- Please type all the necessary information in the empty space and click 'OK' to submit the device information

• Device Info

- Device Name: input the DVR site name which will be displayed on the Server list. Please note that this name has nothing to do with the ID registered in DVR. Users may create the name that is fairly easy to distinguish.
 - Description: type brief description of the site
 - IP Address: input IP address or Domain Name of DVR (check with SETUP>DEVICES>Network in DVR).
 - Command Port: input Administrator's number among port numbers set in DVR (check with SETUP>DEVICES>Network in DVR).
 - Stream Port: INPUT Video/Audio number among port numbers set in DVR (check with SETUP>DEVICES>Network in DVR).
 - User Name: Type authorized ID of the DVR. Default ID is **admin**.
 - Password: Type correspond password of the ID. Default Password is **1111**.
 - Confirm Password: Retype the password to confirm.
- If users want to scan the devices instead of typing the information manually, please click 'Scan device'. It will automatically detect registered DVR units currently connected to local networks.
 - Click "Scan Device", then following 'Dialog' will pop up.

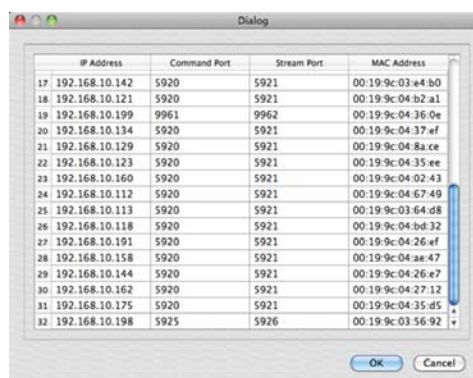

- Including IP address, the information of connected DVRs in the network will be listed.
- Select the one and click 'OK'. Then, the following window will pop up.



- Please fill out all the necessary information including Device name, Description (not necessary), User Name and Password and confirm password. Please note that the User Name and Password have to be same as the DVR setting.
- When users want to edit the existing device information, please choose the device and click 'Edit'.
- When users want to delete the existing device information on the list, please select the device and click 'Remove'.
- If users click the 'Remove' button, it will show the message below.

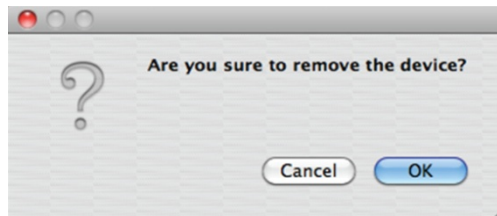

- Please click the 'OK' button to remove the connected device

7.4.2.2 Display Setup

- Please click 'Display Setup' and the following screen will appear.

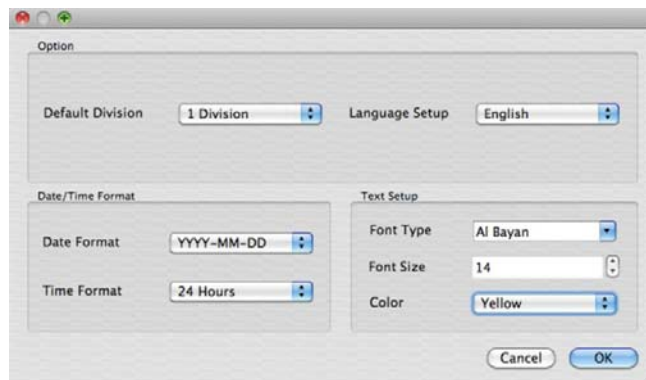

- Users can adjust and set the environment of the display window.
 - Default Division: Users can select the number of division of display channels when the program initially displays the screen. (1, 4, 9, 16, 25, 36 or 64).
 - Users can choose either English or Korean in language setup.

NOTE

This option will be applied after program restarts.

- Date / Time format: Users can adjust and set the mode of date / time display in accordance with the location.
 - Date Format: select the date format among YYYY-MM-DD/MM-DD-YYYY/DD-MM-YYYY.
 - Time Format: select the time format between 24Hours/ 12 Hours AM/PM.
- Display Font: Users can change the font of the name and display time of each channel.
 - Font Type: select the type of font between Arial / Courier.
 - Font Size: select the size of the font from 10 to 20 and the default is 15.
 - Color: select the color among 16 different colors.



7.4.2.3 Password Change

- Please click Password Change in setup menu to change the password.



- Please select the ID from the drop down list and type original password.
- Please type new password and confirm the password below.
- If the information is filled out, click 'OK' to finish the Password change.

7.5 Live View

7.5.1 Connection

- Please choose one of the registered sites in Server list on the right hand side of the 'Live Display' screen and the right click on the mouse button will pop up the menu with 'Connect'.
- Click 'Connect' to connect the DVR to the 'iCMS'.

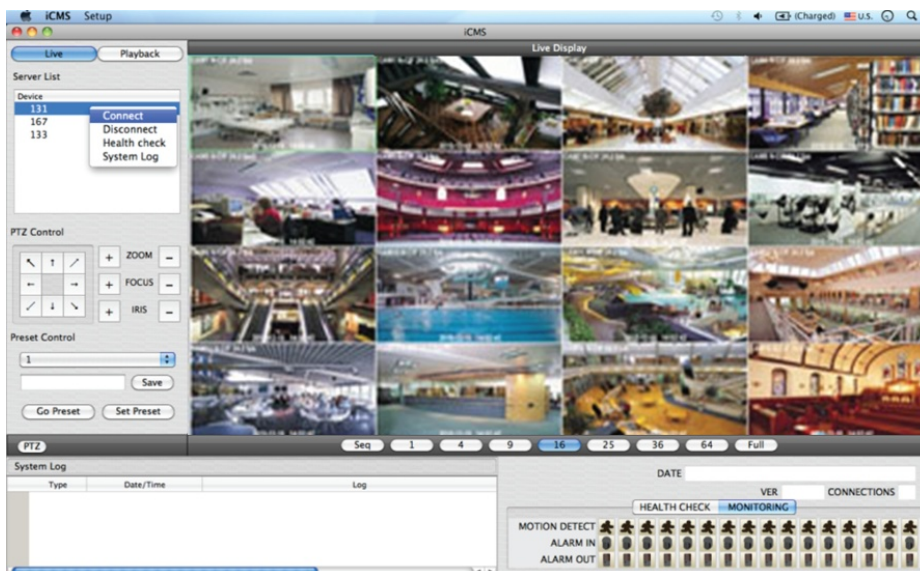

- To have multiple channels, please choose the channel from the bar below the 'Live Display' screen (1, 4, 9, 16, 25, 36, 64 and Full).

7.5.2 Display Mode

- Full Screen Mode: Select a channel and click on number "1" button. Then, the corresponding channel will display in Full Screen.
- Quad Screen Mode: Click on No.4 button and a quad screen will display. The quad screen is in combination of 1~4, 5~8, 9~12 and 13~16. If users select Channel No. 7 and click the button, 5~8 quad screen will display. Similarly, if users select Channel No. 16, 13~16 quad screen will display.
- 9-Split Screen Mode: Click on No.9 button and 9-split screen will display. The 9-split screen is in combination of 1~9 and 8~16. If users select Channel No. 9 and click the button, 1~9 split screens will display. Similarly, if users select Channel No. 10, 8~16 split screens will display.
- 16-Split Screen Mode: Click on No.16 button and 16-split screens will display.
- 25-Split Screen Mode: Click on No.25 button and 25-split screens will display.
- 36-Split Screen Mode: Click on No.25 button and 36-split screens will display.
- 64-Split Screen Mode: Click on No.64 button and 64-split screens will display.
- Seq: Click 'Seq' and then it will show an ordered list of display which will change the channel of live display to next channels. For example, In 4 channel display CH5 to CH8 on the display screen will change to CH9 to CH12 consequently.

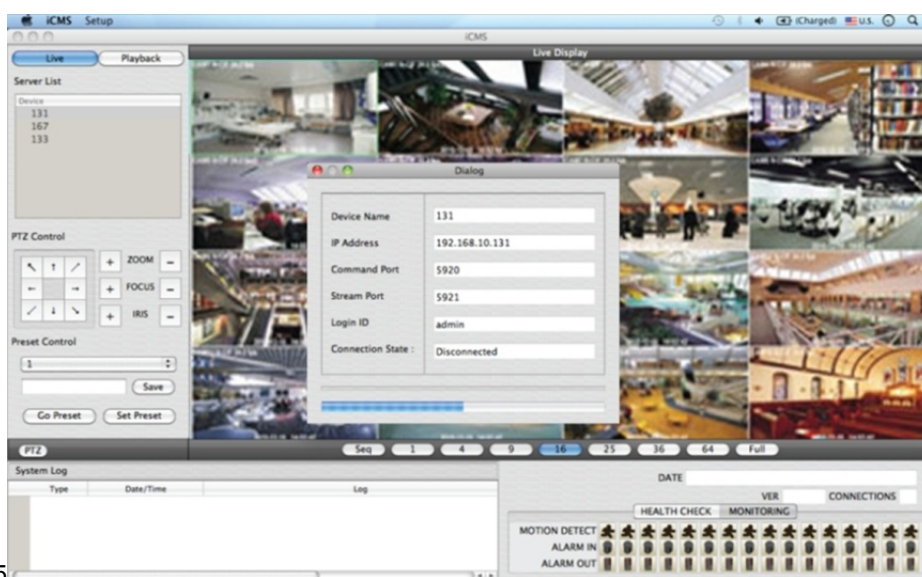

5

NOTE

The selected channel is outlined in blue

7.5.3 Health Check

- Please choose one of the registered sites in Server list on the right hand side of the 'Live Display' and the right click on the mouse button will pop up the menu with 'Health Check'.
- Please choose 'Health check' function when users want to check the status of the DVRs.
- Now users can choose either Health Check or Monitoring to see the status of the DVR at the bottom of the right corner.

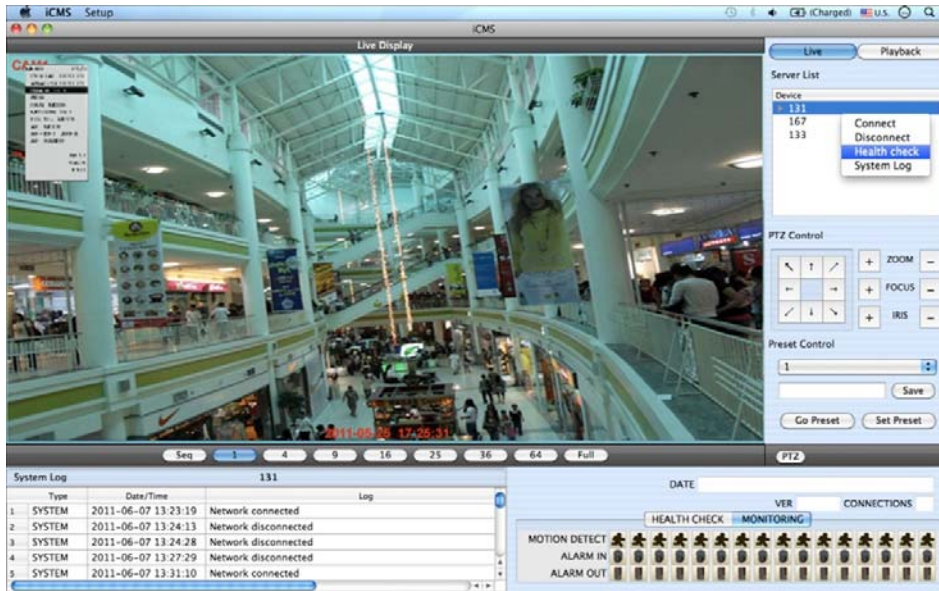

- Health check shows the status of how many cameras are activated, how many HDDs are available, and how many channels are recorded.
- Monitoring shows the status of the number of motion detection and how many alarm in and alarm out are activated.

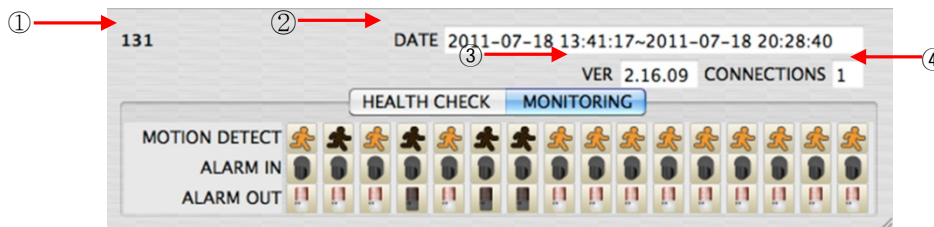

Number	Description
1	DVR name
2	Start and finish recorded date and time
3	The version of the firmware
4	The number of Connected network(ex. CMS, Mobile CMS, etc.) to the DVR

7.5.4 PTZ Control

- Under the server list, PTZ control can be found. This is for the control of Pan/Tilt/Zoom.
- Buttons on the screen have the following functions.
 - Up/Down/Left/Right direction buttons



- Zoom In/Out, Focus Near/Far, Iris Close/Open

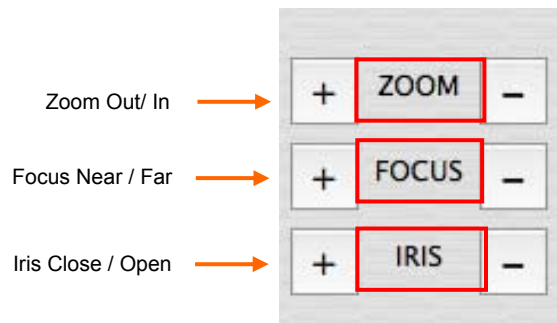

- Preset Control button



- Please choose the number from the drop down list from 1 to 256.
- After selecting the number, please type the description on the empty space below the drop down list and click “Save”.
- If users think that the certain spot is important or need to have precautions, then they can set up the spot as ‘Preset’.
- When the preset is setup up, click ‘Go Preset’ to move to preset spot.
 - PTZ control menu can be hidden by clicking PTZ ICON below the PTZ menu.

7.5.5 System Log

- In the Live mode, system Log is shown. This will allow users to check System Log of Remote Site (DVR).

System Log		131	
Type	Date/Time	Log	
1	SYSTEM	2011-06-07 14:32:14	Network connected
2	SYSTEM	2011-06-07 14:33:18	Network disconnected
3	SYSTEM	2011-06-07 15:05:53	Network connected
4	SYSTEM	2011-06-07 15:06:16	Network disconnected
5	SYSTEM	2011-06-07 15:12:49	Network connected

7.6 Search Mode

- This involves searching recorded video to playback the video of a specific date and time.
- Users are able to search the recorded data in the iCMS program by Date/Time, Event, POS/ATM Search.
 - **Date/Time Search:** search by inputting date/time.
 - **Event Search:** search by event.
 - **POS/ATM Search:** search by POS or ATM text with time.

7.6.1 Date/Time Search

- Click Playback and following screen will appear.

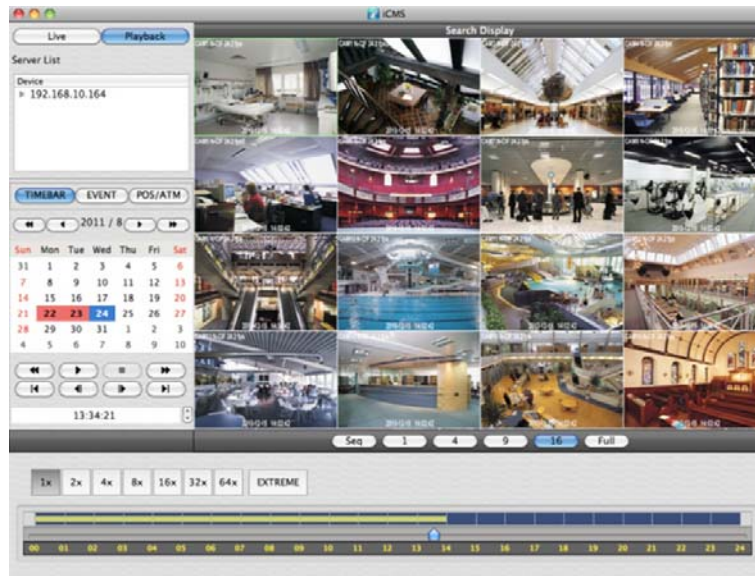

- Please choose one of the devices to playback from the Server List.
- Select Date
 - In calendar, dates with recorded data are marked in red.
- Select the date among the dates marked in red.
- Select Time
 - Please select the time that users want to playback by clicking ▲, ▼ buttons on the right-hand side to adjust the time or drag the Time Select Bar with mouse.



◀◀	Search previous 'Year'
▶▶	Search subsequent 'Year'
◀	Search previous 'Month'
▶	Search subsequent 'Month'

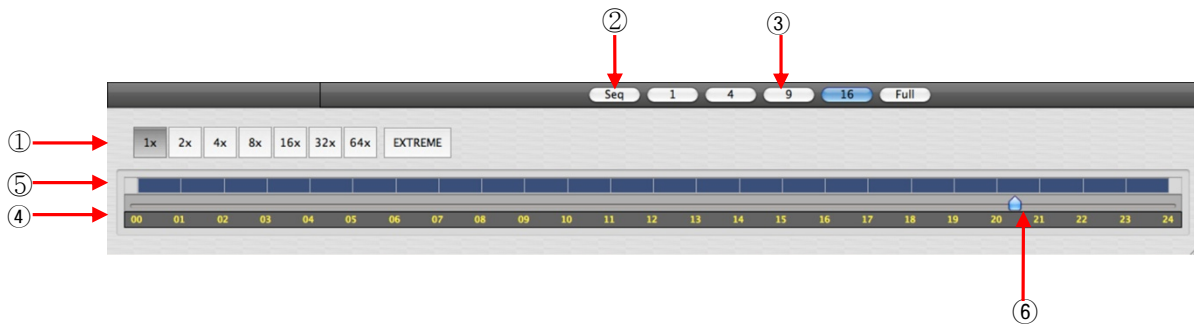

1	Fast Forward/Backward & Playback (Click the button to increase the speed by x1, x2, x4, x8, x16, x32, x64 and Extreme)
2	Sequence Mode
3	Display Mode(Click the button to divide the screen by 1, 4, 9, 16 and Full)
4	Time Bar (24 Hour)
5	Data Bar (Recorded data)
6	Time Select Bar

- When Date/Time search is completed, please click Playback control button to begin playback.

7.6.2 Event Search

- The Event button allows users to search event recorded data of DVR.
- To start the event search, please click '**EVENT**' and users will see the following screen.



- Please choose one of the devices among the '**Server List**' and right click on the mouse to have popup menu with Connect.
- Please click '**Connect**' to start the event search
- Event search has three different parts called Event Type, Select Camera and Date/Time setting.
 - ① **Event Type:** it has three event types which are Emergency, Alarm and Motion. Please choose one event that users want to detect.
 - ② **Select Camera:** Please select the camera that users want to view from Cam1 to Cam 16 for the event (Only 1 camera can be selected).
 - ③ **Date/Time setting:** Please select the begin and end time by clicking the up/down arrows and click "Search"

7.6.3 POS/ATM

- POS/ATM button allows users to search for the POS/ATM text.
- Please click 'POS/ATM' button right next to the 'EVENT' and users will see the following screen.

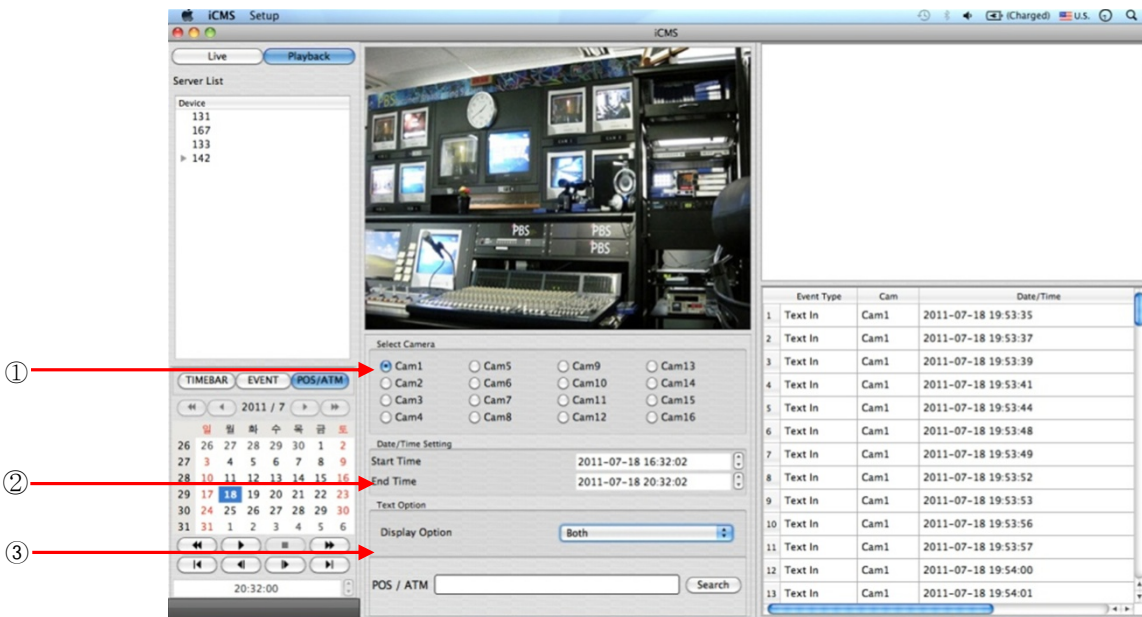

- Please choose one of the devices among the 'Server List' and right click on the mouse to have popup menu.
- Please click 'Connect' to start the event search
- Event search has three different parts called Event Type, Select Camera and Date/Time setting.
 - ① **Select Camera:** select a camera to search (Only 1 camera can be selected in this search).
 - ② **Date/Time setting:** please set up the start and end time
 - ③ **Text Option**
 - **Display Option:** Users are able to select the display option of the playback.
 1. Text window: The detected text will be shown on the 'Windows text' right next to the 'Display screen'.
 2. Overlay: The text will be overlaid on the playback video.
 3. Both: The text will be overlaid on the video and the text window as well.
 4. Hide All: The text will not be displayed in both video and the text window.

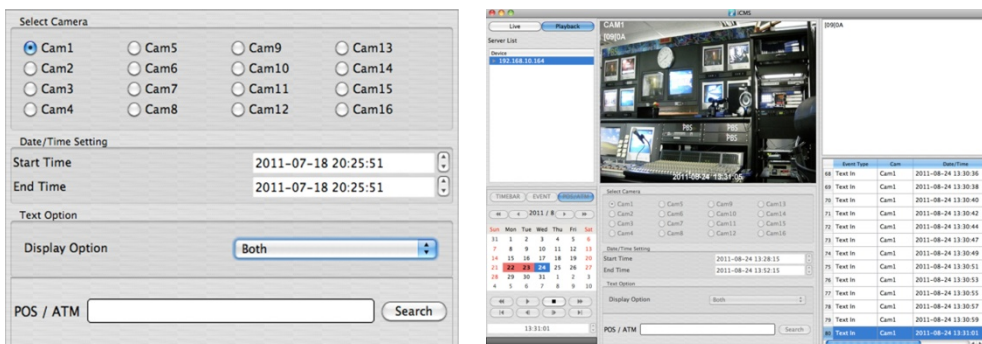

- Display Option – Users are able to select the display option of the playback.
 - ④ Text window: The detected text will be shown on the 'windows text' right next to the display screen.
 - ⑤ Overlay: The text will be overlaid on the playback video.
 - ⑥ Both: The text will be overlaid on the video and will be displayed in the text window as well.
 - ⑦ Hide All: The text will not be displayed in both video and the text window.
- Please fill out the text box with the searching word.

POS / ATM

- Please click 'Search' when all the necessary requirements are filled out..
- The following screen shows the result of the POS/ATM search.

Event Type	Cam	Date/Time	
1	Text In	Cam1	2011-07-18 19:53:35
2	Text In	Cam1	2011-07-18 19:53:37
3	Text In	Cam1	2011-07-18 19:53:39
4	Text In	Cam1	2011-07-18 19:53:41
5	Text In	Cam1	2011-07-18 19:53:44
6	Text In	Cam1	2011-07-18 19:53:48
7	Text In	Cam1	2011-07-18 19:53:49
8	Text In	Cam1	2011-07-18 19:53:52
9	Text In	Cam1	2011-07-18 19:53:53
10	Text In	Cam1	2011-07-18 19:53:56
11	Text In	Cam1	2011-07-18 19:53:57
12	Text In	Cam1	2011-07-18 19:54:00
13	Text In	Cam1	2011-07-18 19:54:01

- Double click on the event to playback of the data.

7.7 Disconnection

- When disconnect, please right click on the connected site and choose 'Disconnect'

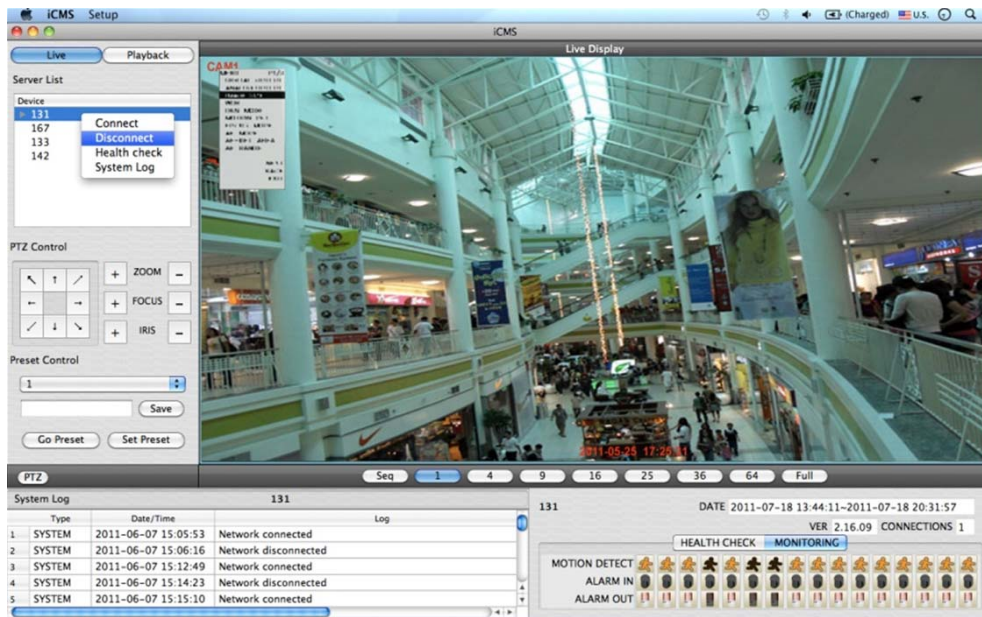

- if users click 'Disconnect', the message box below will appear

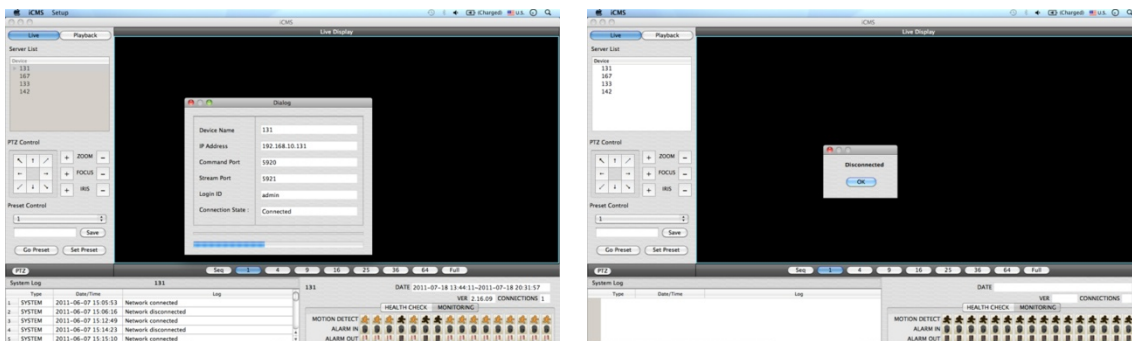

7.8 Uninstall

- Please go into the 'Application' folder and right click on the iCMS icon.



- Please choose 'Move to Trash' to uninstall the iCMS program

xCMS

User`s Manual



8. xCMS VIEWER

8.1 Program Installation

8.1.1 System Recommendations

	Recommended
CPU	Core 2 Duo 2.26GHz or higher
Main Memory	2GB or higher
Display Resolution	1024 x 768 (with 32bit color) or higher
HDD Storage Space	30GB or higher
Network	100~1000 Mbps Fast Ethernet
Operating System	Fedora

NOTE

It is recommended to connect Max. 16 HD-SDI (Full HD) cameras with CMS Pro.

WARNING

CONNECTING MORE THAN 16 HD-SDI (FULL HD) CAMERAS MAY RESULT IN MALFUNCTION OF THE SOFTWARE. TO CONNECT MORE THAN 16 HD-SDI (FULL HD) CAMERAS, PLEASE ENABLE DUAL STREAMING OPTION ON THE DVR.

8.1.2 Program Installation Method

- Please follow the program installation procedures below.
- Please select the 'Activities' on the top left side of the corner, and choose Home directory



- Please select the 'xCMS' file and move the file to the Home directory
- Right click on the mouse and select 'Properties'.



- Please select the 'Permission' on the bar menu.
- Please check the box right next to the "Allow executing file as program" and if users want to give access to other groups, please change the access level to Read and write.

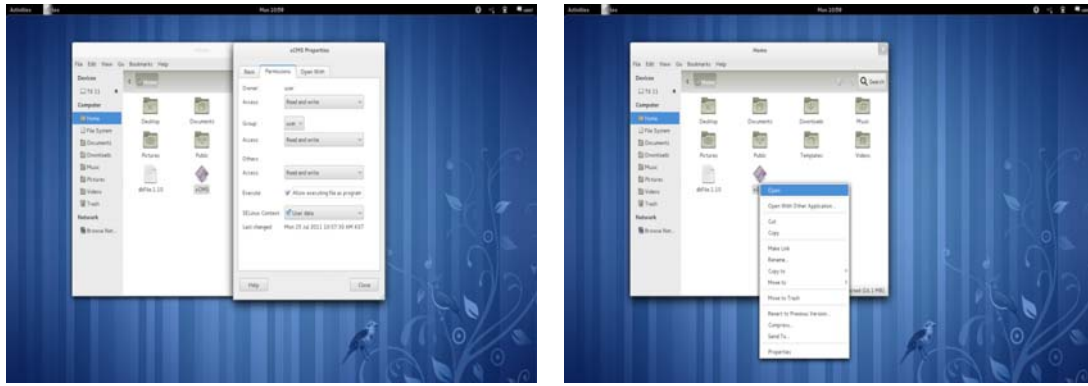

- Right click on the 'xCMS' and select 'Open'

8.2 Login

- Please right-click on the icon and select open to execute the program.
- Select User Name by clicking upside down arrow and enter corresponding Password to login.



8.3 Watch Mode

8.3.1 Login Screen

- After users log into the 'xCMS', the following screen will appear.



8.3.2 Local Setting

- Please click 'Setup' button on the top of the Toolbar and the following screen will appear.
- There are three types of setup menu such as Device Manager, Display Setup and Password Change.

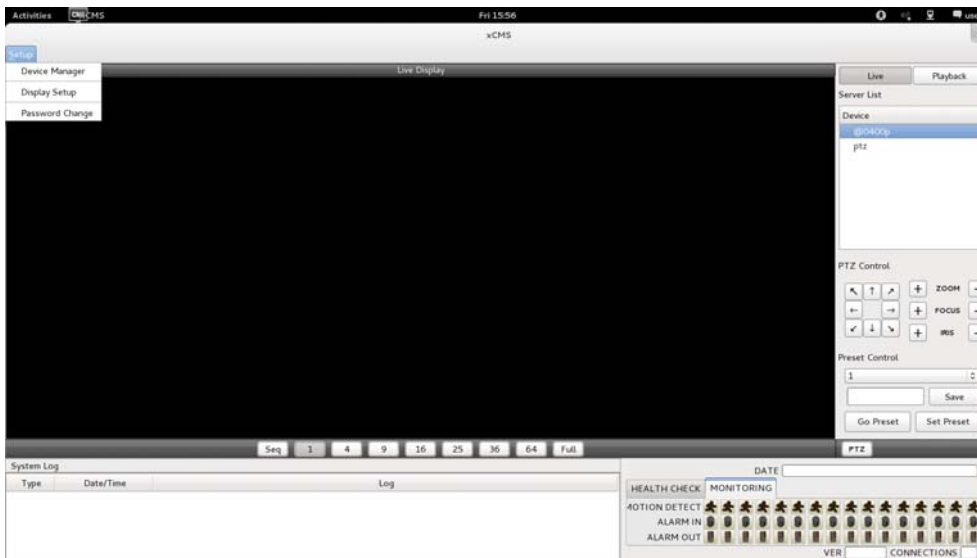

8.3.2.1 Device Manager

- Please click 'Device manager' and the following screen will appear.

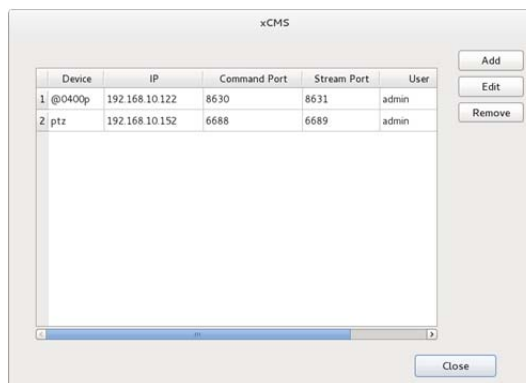

- Users will see the already existing DVRs on the list, if there is any added DVR previously.
- Please click 'Add' to add new device.



- Please type all the necessary information in the empty space and click 'OK' to submit the device information

• **Device Info**

- **Device Name:** input the DVR site name which will be displayed on the Server list. Please note that this name has nothing to do with the ID registered in DVR. Users may create a name that is fairly easy to distinguish.
 - **Description:** type brief description of the site.
 - **IP Address:** input IP address or Domain Name of DVR (check with SETUP>DEVICES>Network in DVR).
 - **Command Port:** input Administrator's number among port numbers set in DVR (check with SETUP>DEVICES>Network in DVR).
 - **Stream Port:** INPUT Video/Audio number among port numbers set in DVR (check with SETUP>DEVICES>Network in DVR).
 - **User Name:** Type authorized ID of the DVR. Default ID is **admin**.
 - **Password:** Type correspond password of the ID. Default Password is **1111**.
 - **Confirm Password:** Retype the password to confirm.
- If users want to scan the devices instead of typing the information manually, please click '**Scan device**'. It will automatically detect registered DVR units currently connected to local networks.
- Click "**Scan Device**", then following '**Dialog**' will pop up.



- Including IP address, the information of connected DVRs in the network will be listed.
- Select the one and click '**OK**'. Then, the following window will pop up.
- Please fill out all the necessary information including Device name, Description (not necessary), User Name and Password and confirm password. Please note that the User Name and Password have to be same as the DVR setting.
- When users want to edit the existing device information, please choose the device and click 'Edit'.
- When users want to delete the existing device information on the list, please select the device and click 'Remove'.
- If users click the 'Remove' button, it will show the message below.

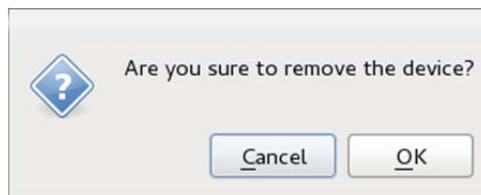

8.3.2.2 Display Setup

- Please click '**Display Setup**' and the following screen will appear.

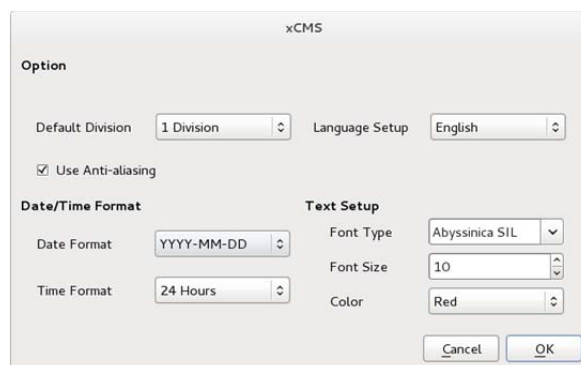

- Users can adjust and set the environment of the display window.
 - Default Division: Users can select the number of division of display channels when the program initially displays the screen. (1, 4, 9, 16, 25, 36 or 64).
 - Users can choose either English or Korean in language setup.

NOTE

This option will be applied after program restarts.

- Date / Time format: Users can adjust and set the mode of date / time display in accordance with the location.
 - Date Format: select the date format among YYYY-MM-DD/MM-DD-YYYY/DD-MM-YYYY.
 - Time Format: select the time format between 24Hours/ 12 Hours AM/PM.
- Display Font: Users can change the font of the name and display time of each channel.
 - Font Type: select the type of font between Arial / Courier.
 - Font Size: select the size of the font from 10 to 20 and the default is 15.
 - Color: select the color among 16 different colors.

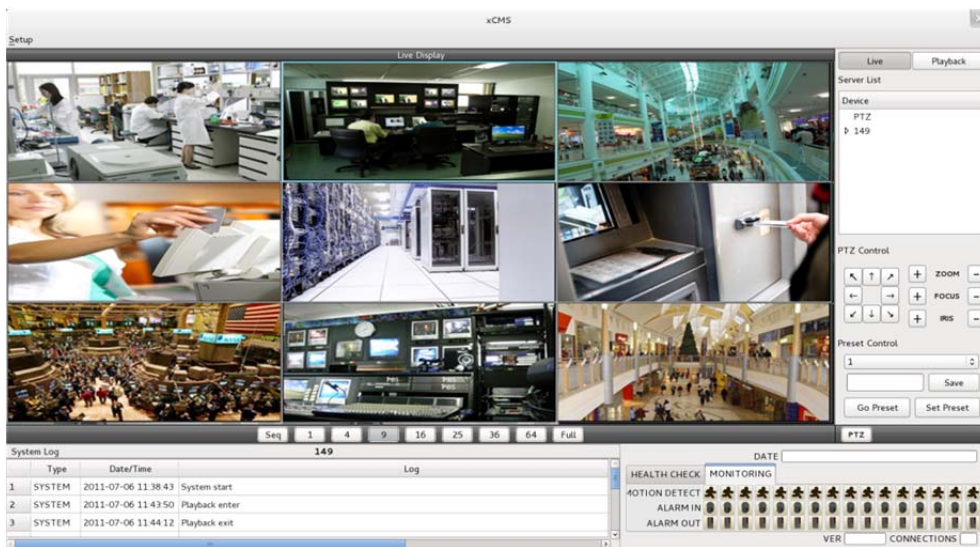

8.3.2.3 Password Change

- Please click Password Change in setup menu to change the password.

The screenshot shows a 'Password change' dialog box with the following fields and buttons:

- ID:** A dropdown menu currently showing 'admin'.
- Password:** A text input field.
- New Password:** A text input field.
- Confirm Password:** A text input field.
- Buttons:** 'Cancel' and 'OK' buttons at the bottom.

- Please select the ID from the drop down list and type original password.
- Please type new password and confirm the password below.
- If the information is filled out, click 'OK' to finish the Password change.

8.3.3 Live

8.3.3.1 Connection

- Please choose one of the registered sites in Server list on the right hand side of the 'Live Display' screen and the right click on the mouse button will pop up the menu with 'Connect'.
- Click 'Connect' to connect the DVR to the 'xCMS'.

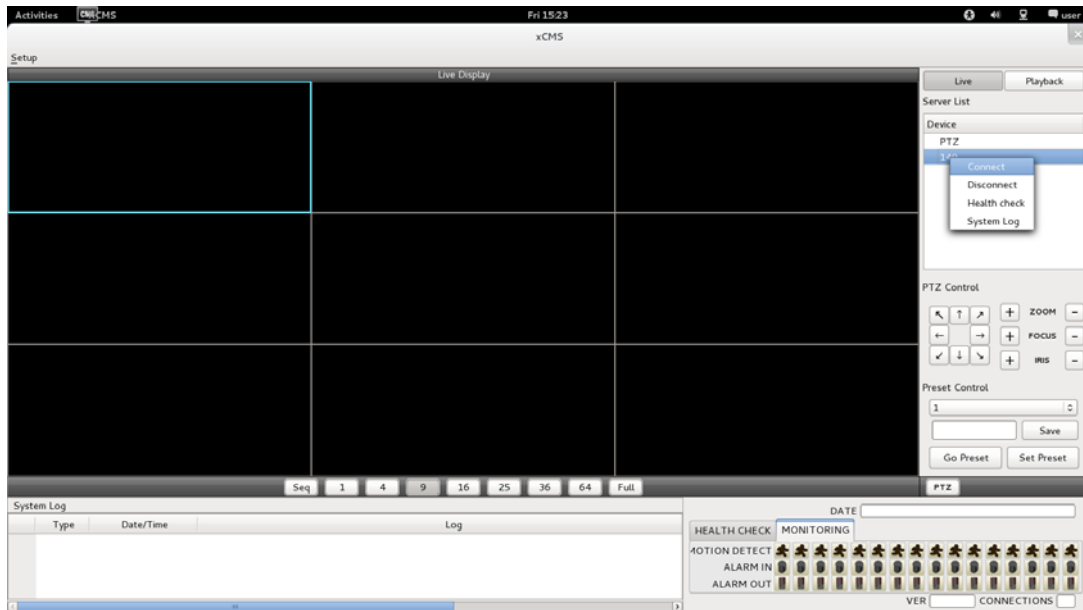

- To have multiple channels, please choose the channel from the bar below the 'Live Display' screen (1, 4, 9, 16, 25, 36, 64 and Full).

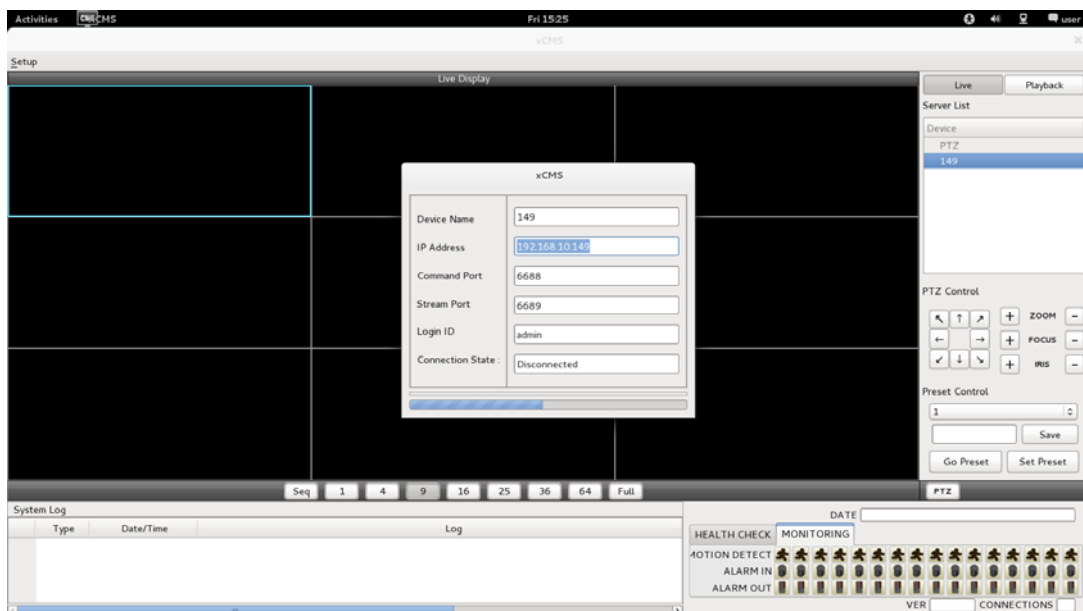

- **Full Screen Mode:** Select a channel and click on number "1" button. Then, the corresponding channel will display in Full Screen.
- **Quad Screen Mode:** Click on No.4 button and a quad screen will display. The quad screen is in combination of 1~4, 5~8, 9~12 and 13~16. If users select Channel No. 7 and click the button, 5~8 quad screen will display. Similarly, if users select Channel No. 16, 13~16 quad screen will display.
- **9-Split Screen Mode:** Click on No.9 button and 9-split screen will display. The 9-split screen is in combination of 1~9 and 8~16. If users select Channel No. 9 and click the button, 1~9 split screens will display. Similarly, if users select Channel No. 10, 8~16 split screens will display.
- **16-Split Screen Mode:** Click on No.16 button and 16-split screens will display.
- **25-Split Screen Mode:** Click on No.25 button and 25-split screens will display.

- **36-Split Screen Mode:** Click on No.25 button and 36-split screens will display.
- **64-Split Screen Mode:** Click on No.64 button and 64-split screens will display.
- **Seq:** Click '**Seq**' and then it will show an ordered list of display which will change the channel of live display to next channels. For example, In 4 channel display, CH5 to CH8 on the display screen will change to CH9 to CH12 sequently.

NOTE

The selected channel is outlined in blue

8.3.3.2 Health Check

- Please choose one of the registered sites in Server list on the right hand side of the '**Live Display**' and then right click on the mouse button will pop up the menu with 'Health Check'.
- Please choose '**Health check**' function when users want to check the status of the DVRs.
- Now users can choose either Health Check or Monitoring to see the status of the DVR at the bottom of the right corner.

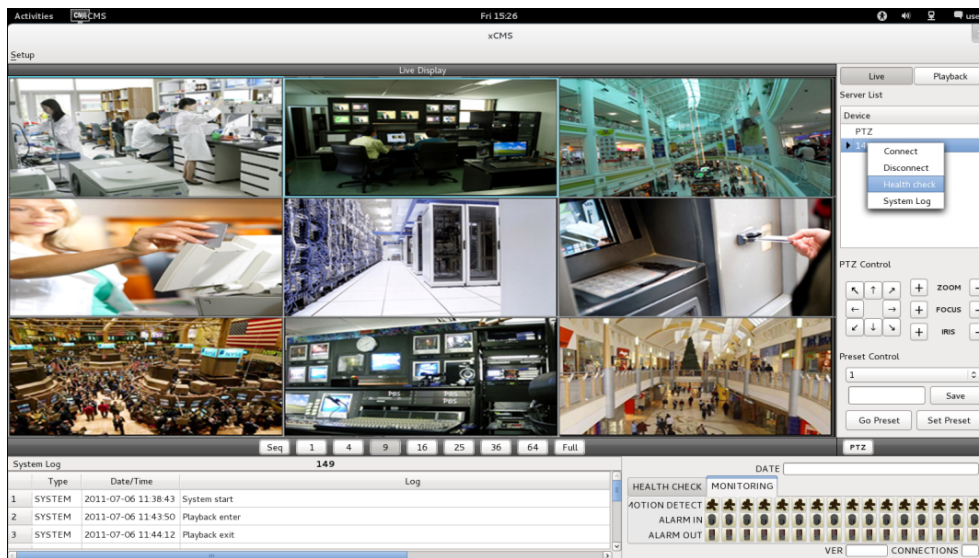

- Health check shows the status of how many cameras are activated, how many HDDs are available, and how many channels are recorded.
- Monitoring shows the status of the number of motion detection and how many 'Alarm In' and 'Alarm Out' are activated.

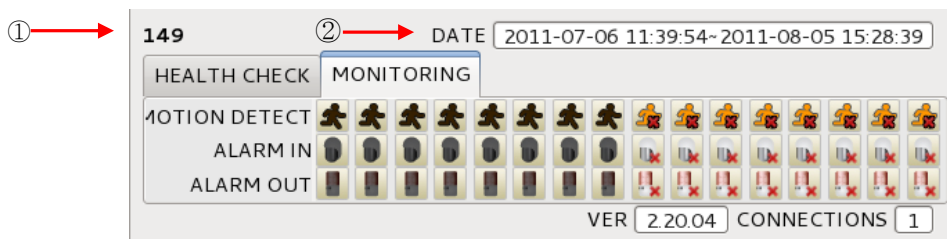

Number	Description
(1)	DVR name
(2)	Start and finish recorded date and time

8.3.3.3 PTZ Control

- Under the server list, PTZ control can be found. This is for the control of Pan/Tilt/Zoom of DVR.
- Buttons on the screen have the following functions.
 - Up/Down/Left/Right direction buttons



- Zoom In/Out, Focus Near/Far, Iris Close/Open

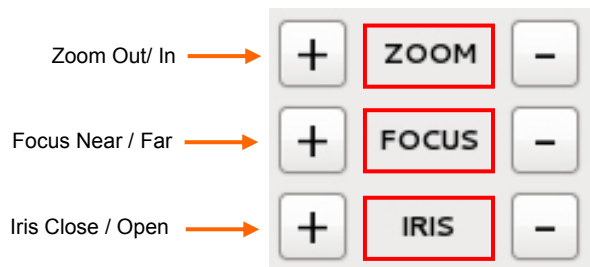

- Preset Control button

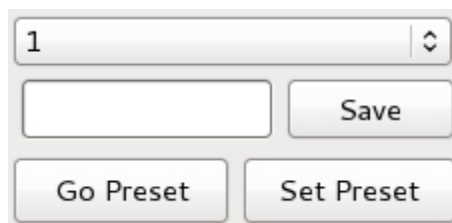

- Please choose the number from the drop down list from 1 to 256.
- After selecting the number, please type the description on the empty space below the drop down list and click "Save".
- If users think that the certain spot is important or need to have precautions, then they can set up the spot as 'Preset'.
- When the preset is setup up, click 'Go Preset' to move to preset spot.
 - PTZ control menu can be hidden by clicking PTZ ICON below the PTZ menu.

8.3.3.4 System Log

- In the Live mode, system Log is shown. This will allow users to check System Log of Remote Site (DVR).

System Log		149	
	Type	Date/Time	Log
1	SYSTEM	2011-07-06 11:38:43	System start
2	SYSTEM	2011-07-06 11:43:50	Playback enter
3	SYSTEM	2011-07-06 11:44:12	Playback exit

8.4 Search Mode

- This involves searching recorded video to playback the wanted video of a specific date and time.
- Users are able to search the recorded data in the xCMS program by Date/Time, Event, POS/ATM Search.
 - **Date/Time Search:** search by inputting date/time.
 - **Event Search:** search by event.
 - **POS/ATM Search:** search by POS or ATM text with time.

8.4.1 Date/Time Search

- Click Playback and following screen will appear.

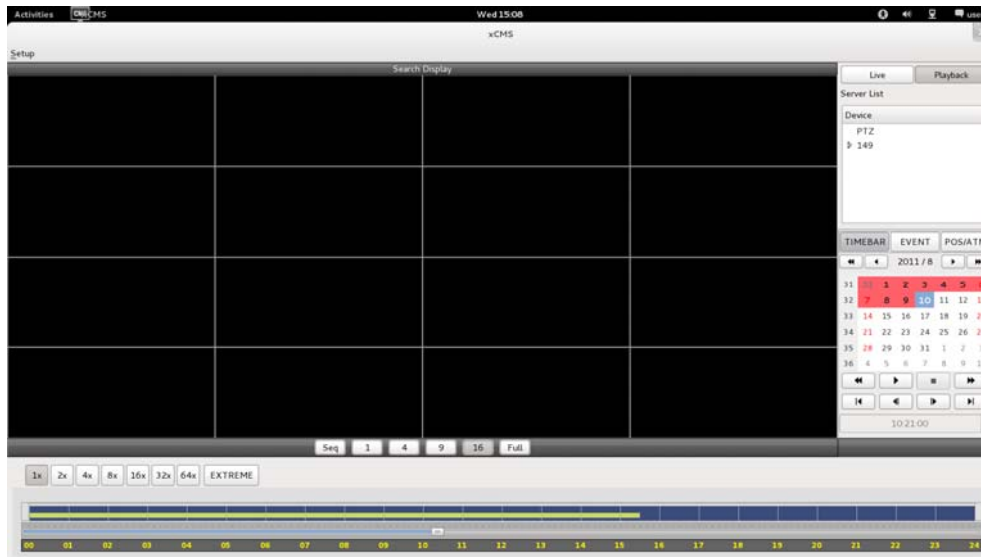

- Please choose one of the devices to playback from the Server List.
- Select Date
 - In calendar, dates with recorded data are marked in red.
- Select the date among the dates marked in red.
- Select Time
 - Please select the time that users want to playback by click ▲, ▼ buttons on the right-hand side to adjust the time or drag the Time Select Bar with mouse.

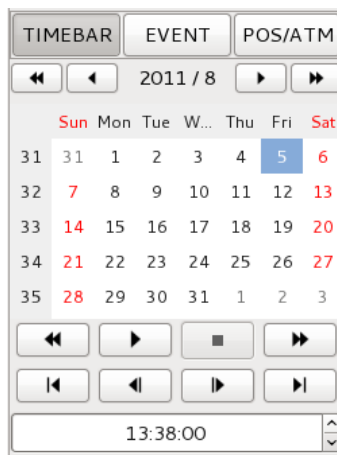

◀◀	Search previous 'Year'
▶▶	Search subsequent 'Year'
◀	Search previous 'Month'
▶	Search subsequent 'Month'

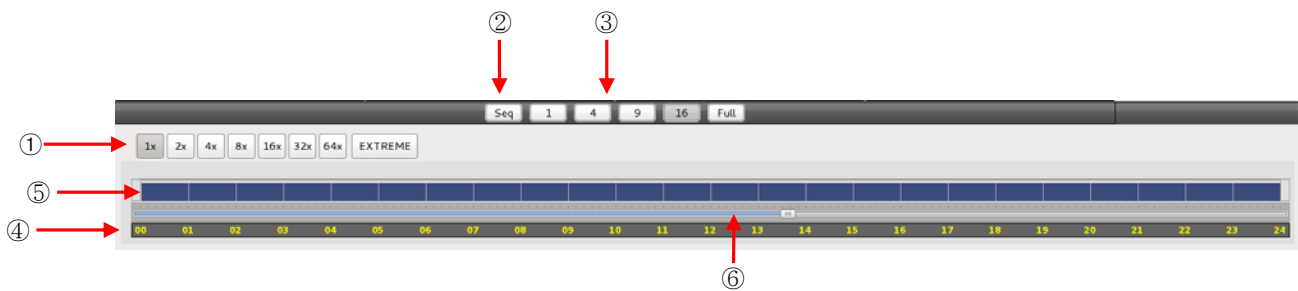

1	Fast Forward/Backward & Playback (Click the button to increase the speed by x1, x2, x4, x8, x16, x32, x64 and Extreme)
2	Sequence Mode
3	Display Mode(Click the button to divide the screen by 1, 4, 9, 16 and Full
4	Time Bar (24 Hour)
5	Data Bar (Recorded data)
6	Time Select Bar

- When Date/Time search is completed, please click 'Play' button to begin playback.

8.4.2 Event Search

- The Event search allows users to search event recorded data of DVR.
- To start the event search, please click '**EVENT**' and users will see the following screen.

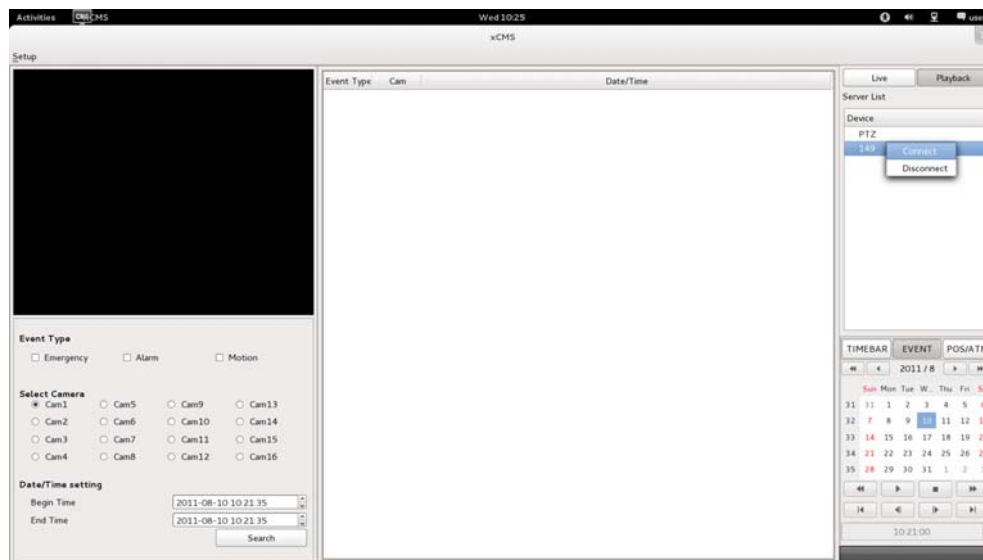

- Please choose one of the devices among the '**Server List**' and right click on the mouse to have popup menu with Connect.
- Please click '**Connect**' to start the event search
- Event search has three different parts called Event Type, Select Camera and Date/Time setting.
 - ① **Event Type**: it has three event types which are Emergency, Alarm and Motion. Please choose one event that users want to detect.
 - ② **Select Camera**: Please select the camera that users want to view from Cam1 to Cam 16 for the event (Only 1 camera can be selected).
 - ③ **Date/Time setting**: Please select the begin and end time by clicking the up/down arrows and click "Search"

8.4.3 POS/ATM

- POS/ATM button allows users to search for the POS/ATM text.
- Please click 'POS/ATM' button right next to the 'EVENT' and users will see the following screen.

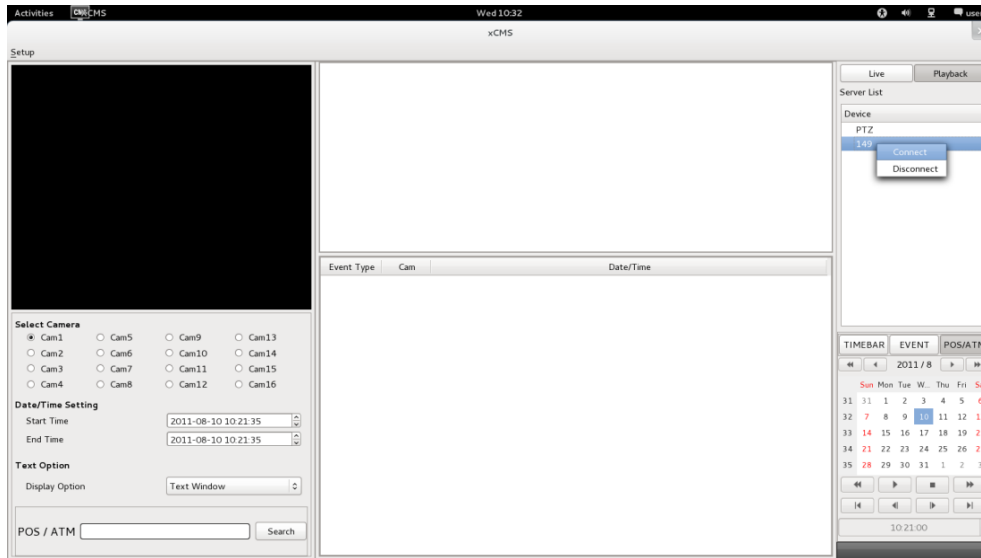

- Please choose one of the devices among the 'Server List' and right click on the mouse to have popup menu.
- Please click 'Connect' to start the event search
- Event search has three different parts called Event Type, Select Camera and Date/Time setting.
 - ① **Select Camera:** select a camera to search (Only 1 camera can be selected in this search).
 - ② **Date/Time setting:** please set up the start and end time
 - ③ **Text Option (Display Option:** Users are able to select the display option of the playback.)
 - Text window: The detected text will be shown on the 'Windows text' right next to the 'Display screen'.
 - Overlay: The text will be overlaid on the playback video in the 'Display Screen'.
 - Both: The text will be overlaid on the video and the text window as well.
 - Hide All: The text will not be displayed in both video and the text window.

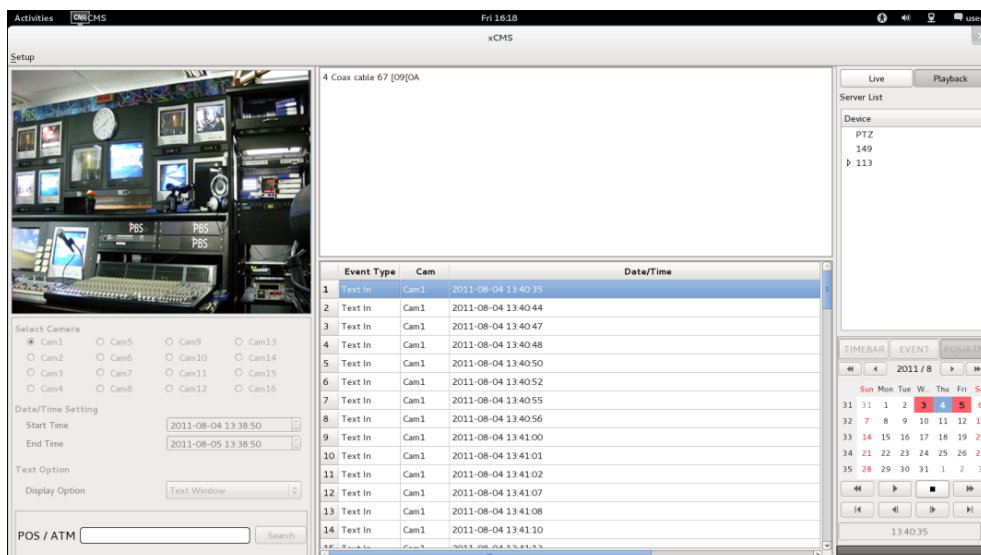

- To search the word, please fill out the text box with the searching word.



- Please click 'Search' when all the necessary requirements are filled out.

- The following screen shows the result of the POS/ATM search

Event Type	Cam	Date/Time
1	Text In	Cam1 2011-08-04 13:40:35
2	Text In	Cam1 2011-08-04 13:40:44
3	Text In	Cam1 2011-08-04 13:40:47
4	Text In	Cam1 2011-08-04 13:40:48
5	Text In	Cam1 2011-08-04 13:40:50
6	Text In	Cam1 2011-08-04 13:40:52
7	Text In	Cam1 2011-08-04 13:40:55
8	Text In	Cam1 2011-08-04 13:40:56
9	Text In	Cam1 2011-08-04 13:41:00
10	Text In	Cam1 2011-08-04 13:41:01
11	Text In	Cam1 2011-08-04 13:41:02
12	Text In	Cam1 2011-08-04 13:41:07
13	Text In	Cam1 2011-08-04 13:41:08
14	Text In	Cam1 2011-08-04 13:41:10

- Double click on the event that users want to display.

8.5 Disconnection

- When disconnect, please right click on the connected site and choose 'Disconnect'

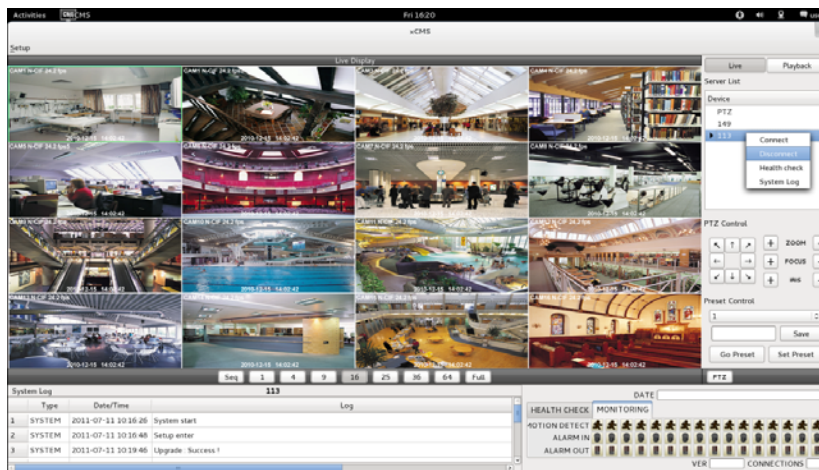

- Once users click 'Disconnect', following screen will appear with the message of 'Disconnected'.

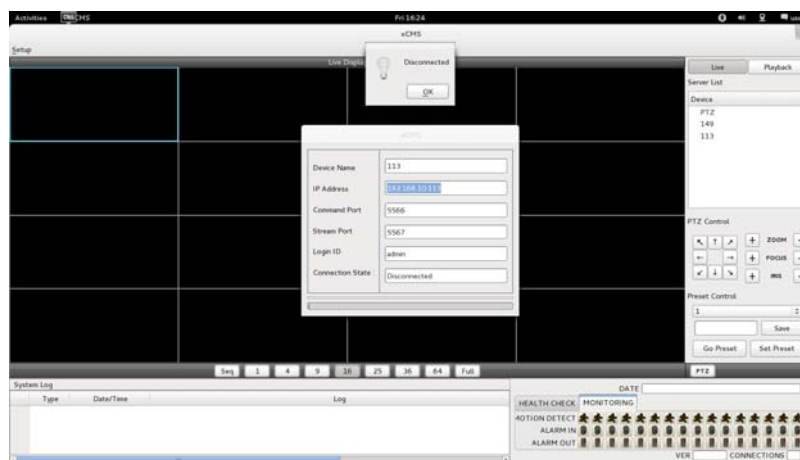

8.6 Uninstall

- Please go into the **'Home'** folder and right click on the xCMS icon.
- Please choose **'Move to Trash'** to uninstall the xCMS program.

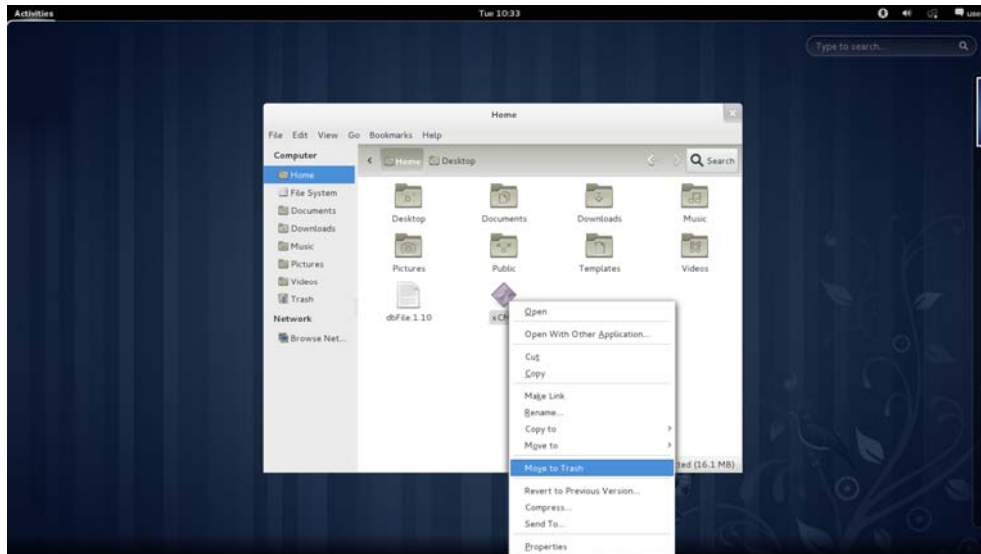

CMS Web Client Pro

User`s Manual

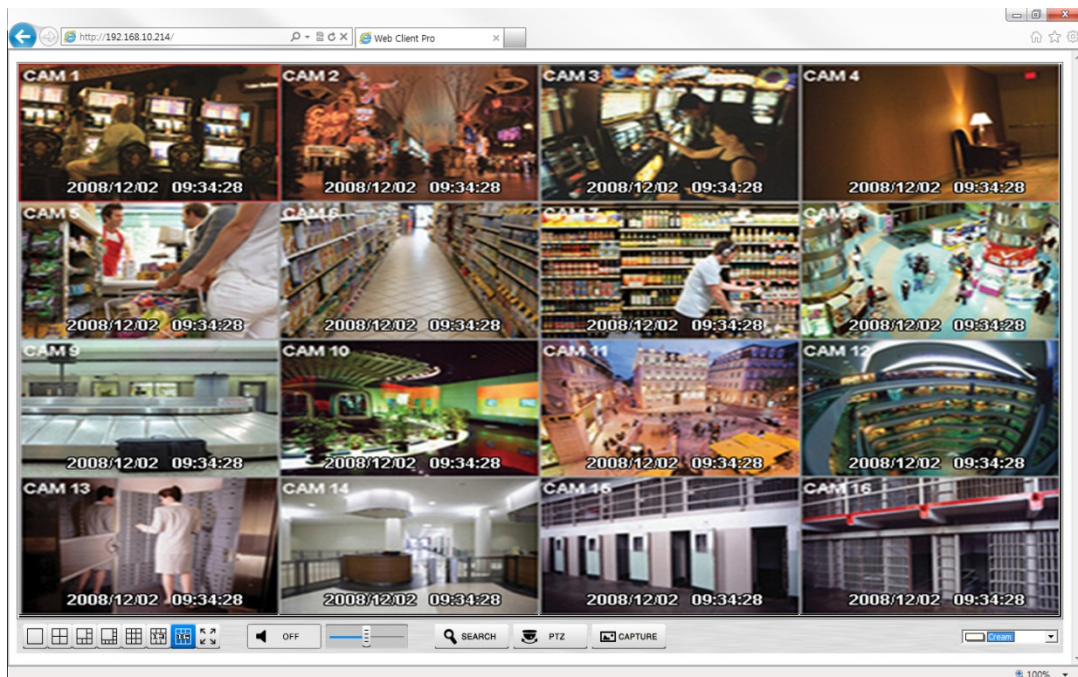

9. CMS WEB CLIENT Pro

9.1 System Requirements

- Web Client Pro may not run properly if the PC does not meet minimum requirements. Other programs should not run on the same PC where this is running. Otherwise, Web Client Pro software may not perform as designed.

	Minimum (Enable Dual Streaming)	Recommended (Disable Dual Streaming)
CPU	Intel Core i5	Intel Core i7
Main Memory	2GB	4GB or higher
Video Memory	1GB	2GB or higher
Display Resolution	1024 x 768 (with 32bit color) or higher	
HDD Storage Space	160GB or higher	
Network	100~1000 Mbps Fast Ethernet	
Operating System	Windows XP Professional SP3 / Windows 7 (32/64) / Windows 8 (32/64)	
Others	DirectX 9.0 C or higher	

9.2 Setup and Login

- MS Explorer web browser is required to install ActiveX in order to use this program.
- Open a browser and type the IP address of DVR.
- It is required to install ActiveX in the first connection.
- Basically, Explorer limits automatic ActiveX installation.
- Click the message above in the screen, then following menu box will appear.

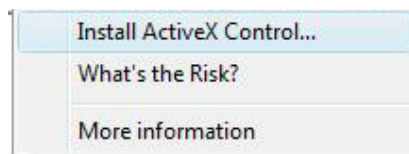

- Click "Install ActiveX Control..." and start installation.
- Installation box will appear and click "Install" for next step.
- After complete installation, Login panel will appear.
- Enter User ID and password of registered DVR then click

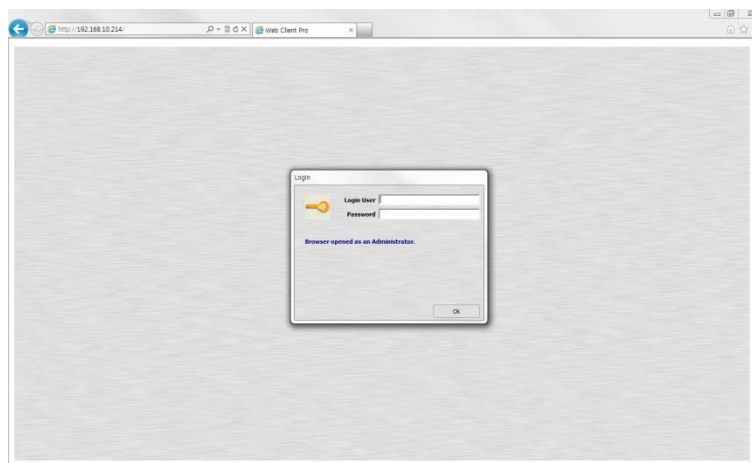

NOTE

Before network connection, be sure that HDD is installed. Otherwise, the DVR will not be connected over network.

9.3 Live Display

- After Login, following screen will appear.

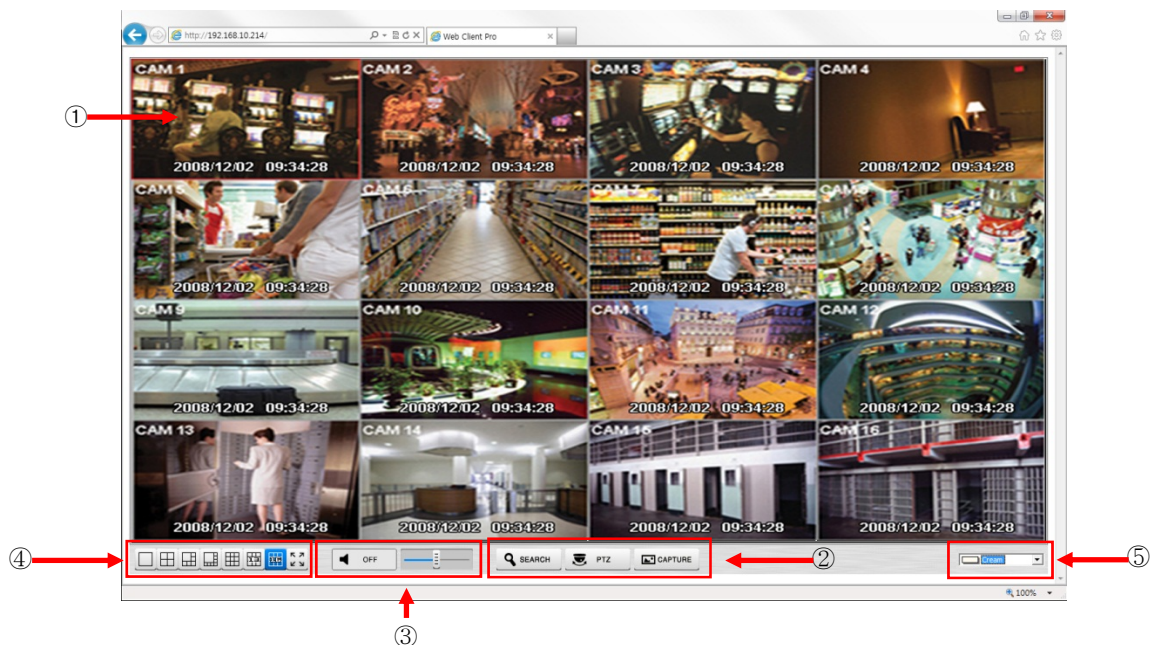

- The screen contains following features:
 - ① Display current live video
 - ② Setting display mode
 - Search: Opening search mode in new window.
 - PTZ: Open PTZ control panel.
 - Capture: Capturing the image of selected channel.
 - ③ Audio controller
 - Able to control the volume.
 - ④ Select display split mode. User can choose 1, 4, 6, 8, 9, 13, 16 and Full screen.
 - ⑤ OSD Font color
 - Able to change the color of the OSD font.
- Additional features can be found with Right click on Live screen.
 - ① Digital zoom(1CH Display ONLY)
 - Able to Zoom in for precise monitoring.
 - ② Audio On/Off
 - Able to turn on/off Audio function.
 - ③ Display Option
 - Show Camera Name: Display Camera Name on OSD
 - Show Date/Time: Display Date/Time on OSD
 - ④ About
 - Display version information.

9.4 Search Screen

- Click  then following screen will appear on a new window.

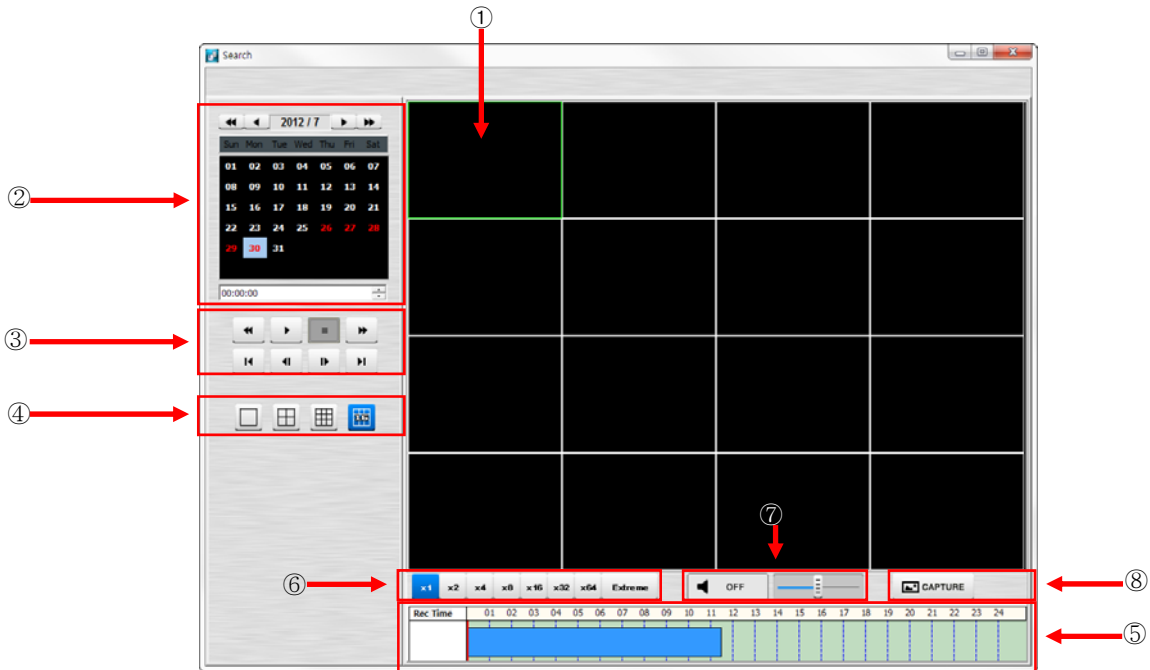

- The screen contains following features:

- ① Searched playback video displays.
- ② Setting Date/Time to search.
 - Click a date in calendar, then recorded data will be showed up in Time bar.
 - Start Time : Setting start time.
 - Camera : Choosing camera number from 1~16 individually or all channels.
- ③ Play functions for playback.

	Fast Backward Play
	Fast Forward Play
	Play
	Stop
	Go to the First Image
	Go to the Last Image
	Go to the Previous Image
	Go to the Next Image

- ④ Select display split mode. User can choose 1,4,9,16 split display consequently.
- ⑤ Indicate the recorded data in Time bar figure.
- ⑥ Select playback speed. User can choose x1, x2, x4, x8, x16, x32, x64 and Extreme.
- ⑦ Audio controller
 - Able to turn on/off Audio.
 - Able to control the volume
- ⑧ Capturing the image of selected channel.

9.5 PTZ Control

NOTE

Must complete the control setting on its DVR and Cameras first.

- Click  PTZ then following screen will appear on a new window.

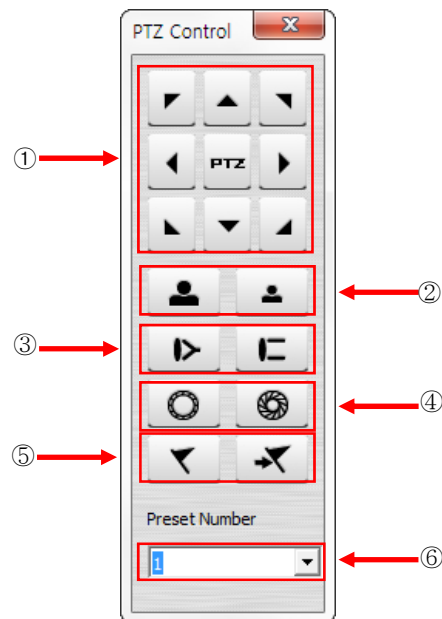

- The screen contains following features:
 - ① Pan/Tilt Direction button.
 - ② Zoom In / Zoom Out control button.
 - ③ Focus Near / Focus Far control button.
 - ④ Iris control button
 - ⑤ Preset control button
 - ⑥ Camera select button.

9.6 Capture

- Click  then following screen will appear on a new window.

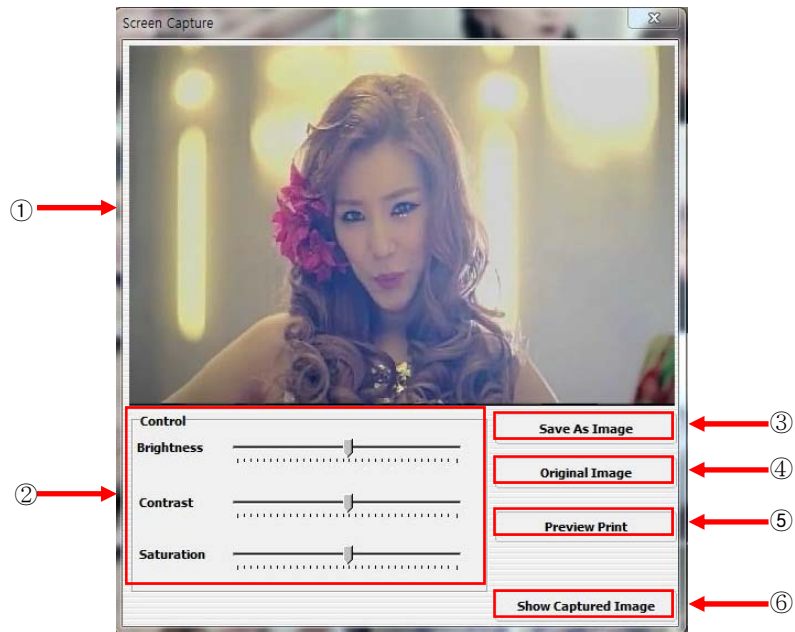

- The screen contains following features:
 - ① Captured Image is displayed.
 - ② Color Control
 - User can change Brightness, Contrast and Saturation of the captured image.
 - ③ Save as Image
 - User can save the edited image in new name.
 - ④ Original Image
 - User can undo all modification made to the image.
 - ⑤ Preview Print
 - Able to see print preview.
 - ⑥ Show Captured Image
 - Display all the previous captured images

CMS Mobile Viewer

User`s Manual



10. CMS MOBILE VIEWER

10.1 iPhone Mobile

10.1.1 System Requirements

- There are no other requirements to run this program because it is specialized to perform on iPhone interface.

10.1.2 Installation



- Turn on the iPhone then connect to App Store.

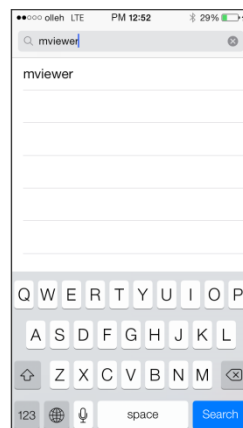

- Move to search menu and type “mviewer” then click “”.



- Select “” program which is offered by dvrdomain for free.

- When user clicks a “**FREE**” button, it will be turned to “**INSTALL**”
- Click “**INSTALL**” to start installation.

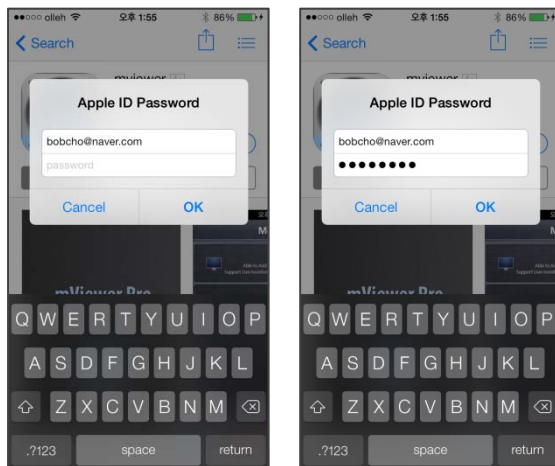

- If user already has iTunes account, then input user's account to download the program.

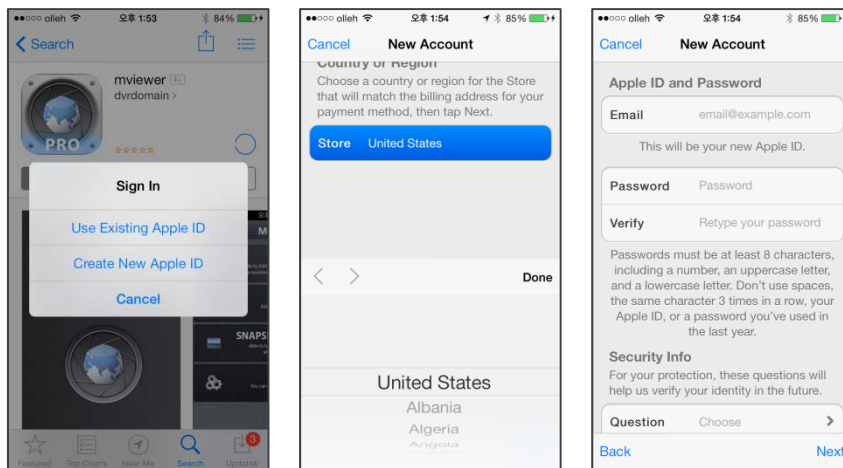

- If user does not have the account, then click “**Create New Apple ID**” and it is registered by free.

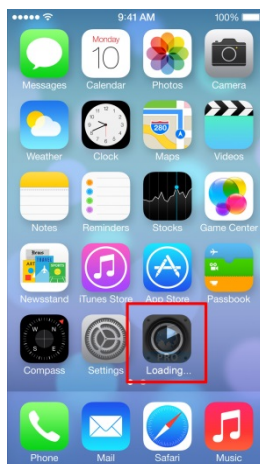

- When user registered the account, the program will be automatically installed.

10.1.3 Site Registration

- Click “” icon on iPhone then below will show.





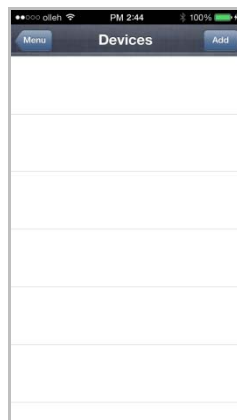

- Tap “**MONITORING**” then below will show.

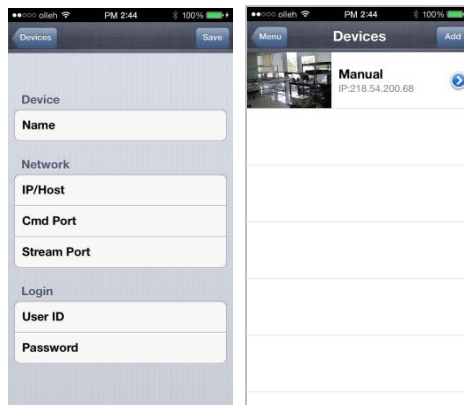

- Tap “” and enter site information which are same as CMS site registration.



- Enter Site Name, IP or DDNS address.
- Enter Admin/Stream port value.
- Enter ID/Password.
- Click “” to save the setting.
- To edit the saved site, tap “” next to site Name, then change the value, and tap “”.
- To delete the saved site, slide the finger from right to left across Device Name. Then tap “” to remove the site.

10.1.4 Connection

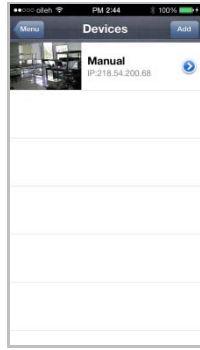





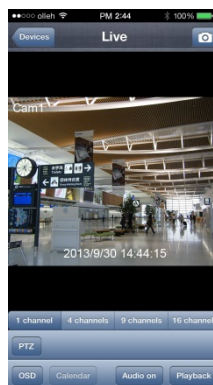

- Tap on Device Name to connect the DVR to iPhone.

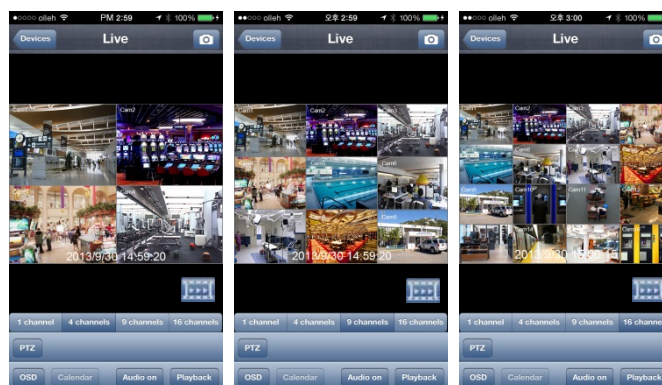
10.1.5 Live View (Portrait View)



- To select other channels,
 - Slide finger from Right to Left to ascend.
 - Slide finger from Left to Right to descend.
- Tap on “ 1 channel 4 channels 9 channels 16 channels ” to choose split mode between 1, 4, 9 and 16.
 - In Multi-channel display mode, user can double tap on certain channel to change to 1CH display mode.



- Tap “” to take Snapshot.
- “” to enable Frame skip.
- Tap “” to enable PTZ function. Please refer to 10.1.7 PTZ Control for more detail.
- Tap “” to remove Camera Name and Date/Time from OSD.
- Tap “” to switch from Live mode to Playback mode.

- Tap “**Audio on**” to enable audio. (1CH display ONLY)
- Tap “**Audio off**” to disable audio. (1CH display ONLY)
- To use Zoom feature, simply pinch and drag in 1CH display. (1CH display ONLY)

NOTE

Audio, Zoom and PTZ are available only in full screen mode.(1channel only)

NOTE

If user enable frame skip, used memories will be stable and It's possible to use it on live mode and playback mode.

10.1.6 Live View (Landscape View)



- To select other channels,
 - Slide finger from Right to Left to ascend.
 - Slide finger from Left to Right to descend.
- Tap on “ ” to choose split mode between 1, 4, 9 and 16.
 - In Multi-channel display mode, user can double tap on certain channel to change to 1CH display mode.
- Tap “**Back**” to go back to main menu.
- Tap “**PTZ**” to enable PTZ function. Please refer to 10.1.7 PTZ Control for more detail.
- Tap “” to take Snapshot.
- Tap “**Audio**” to enable audio. (1CH display ONLY)
- To use Zoom feature, simply pinch and drag in 1CH display. (1CH display ONLY)

NOTE

Audio, Zoom and PTZ are available only in full screen mode.(1channel only)

10.1.7 PTZ Control

- Users are able to control PTZ with iPhone by touching the screen.



- Tap “PTZ” to execute PTZ function.



- Tap Arrow for Pan and Tilt movement.

- Touch “” to zoom out.

- Touch “” to zoom in.

- If users already set up the presets on DVR, users may use them by touching “  ”.

10.1.8 Search

- Users are able to search the recorded data with iPhone.

- Click “PLAYBACK” on Main menu or “Playback” on Live monitoring to use search function.



- Choose date that wish to search from Calendar



- Choose time to search by sliding the Hour and Minute bar.

- Tap “**Search**” to execute search.



- To select other channels,
 - Slide finger from Right to Left to ascend.
 - Slide finger from Left to Right to descend.

- Tap on “1 channel 4 channels 9 channels 16 channels” or “ ” to choose split mode between 1, 4, 9 and 16.
 - In Multi-channel display mode, user can double tap on certain channel to change to 1CH display mode.

- Tap “ ” to control the playback.

- Tap “” or “” to take Snapshot.

- Tap “**OSD**” or tap screen to remove Camera Name and Date/Time from OSD.

- Tap “**Live**” to switch from Live mode to Playback mode.

- Tap “**Audio on**” or “**Audio**” to enable audio. (1CH display ONLY)

- Tap “**Audio off**” or “**Audio**” to disable audio. (1CH display ONLY)

- To use Zoom feature, simply pinch and drag in 1CH display. (1CH display ONLY)

NOTE

Audio, Zoom and PTZ are available only in full screen mode.(1channel only)

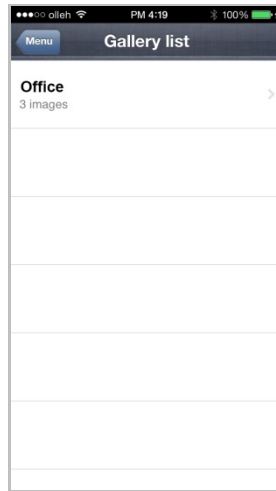

10.1.9 Snapshot gallery

- Users are able to watch the snapshot taken with mViewer while Live monitoring and Playback.
- Tap “Snapshot gallery” from main menu.

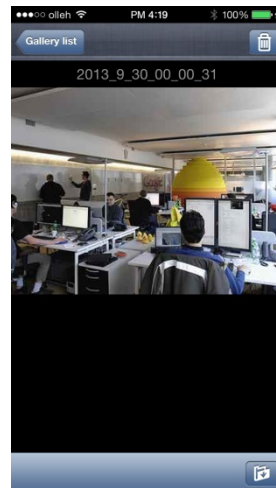

- Select the device and snapshot taken from the selected device will appear.



- To see other pictures slide finger across the screen.
- Tap “” to send the snapshot to the Photos.
- Tap “” to delete the selected snapshot.

10.1.10 Setting

- Tap “**SETTING**” to check the information of the application.
- User can read the manual.





10.1.11 Uninstallation

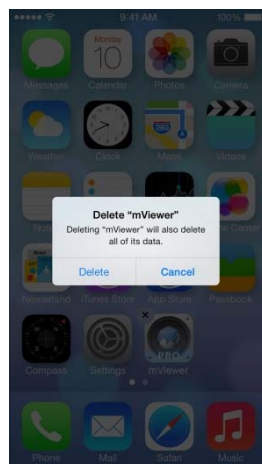

- Click the “” icon and hold for a while until the program icon shows x mark on the top-left side.



- Click the “” icon then it will ask to delete the program.
- Click “” button to successfully uninstall the program.

10.2 iPad Mobile

10.2.1 System Requirements

- There are no other requirements to run this program because it is specialized to perform on iPad interface.

10.2.2 Installation

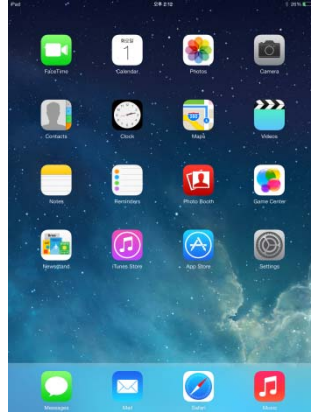

- Turn on the iPad then connect to App Store.

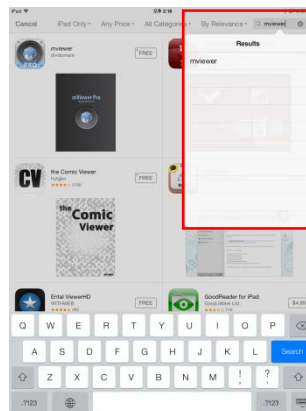

- Move to search menu and type “mviewer” then click “**Search**”.

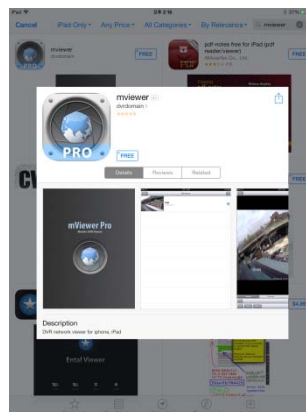

- Select “” program which is offered by dvrdomain for free.
- When user clicks a “**+ FREE**” button, it will be turned to “**INSTALL**”

- Click “ **INSTALL** ” to start installation.

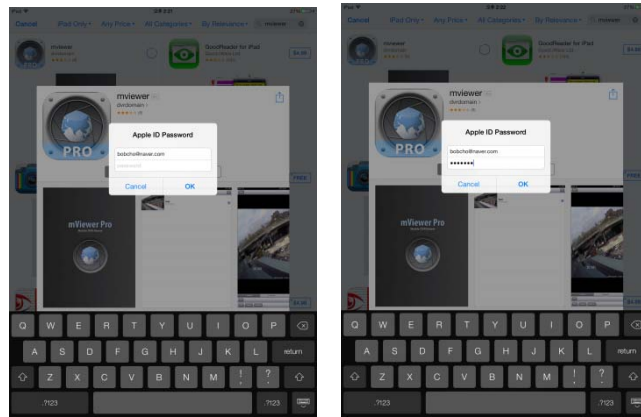

- If user already has iTunes account, then input user's account to download the program.

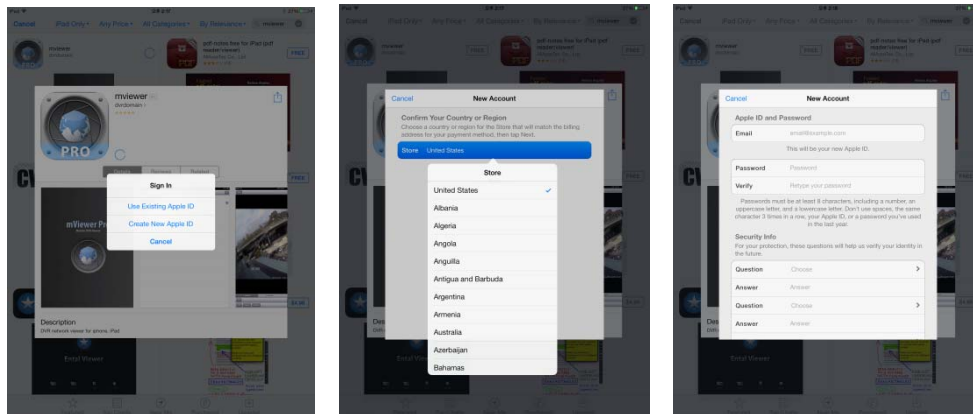

- If user does not have the account, then click “ **Create New Apple ID** ” and it is registered by free.

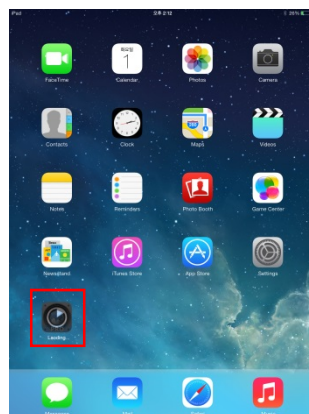

- When user registered the account, the program will be automatically installed.



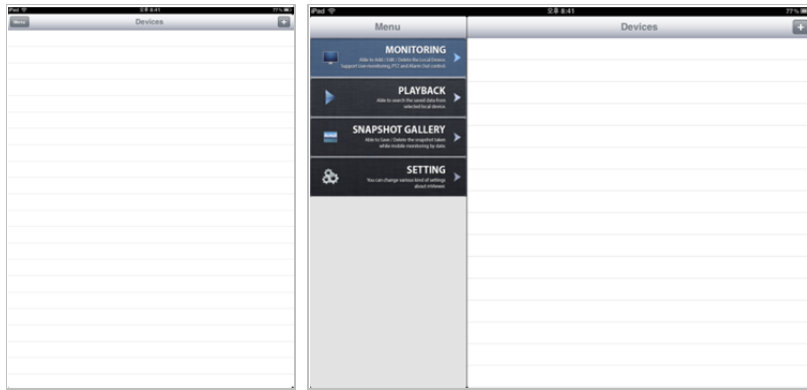

10.2.3 Site Registration

- Click “” icon on iPad then below will show.

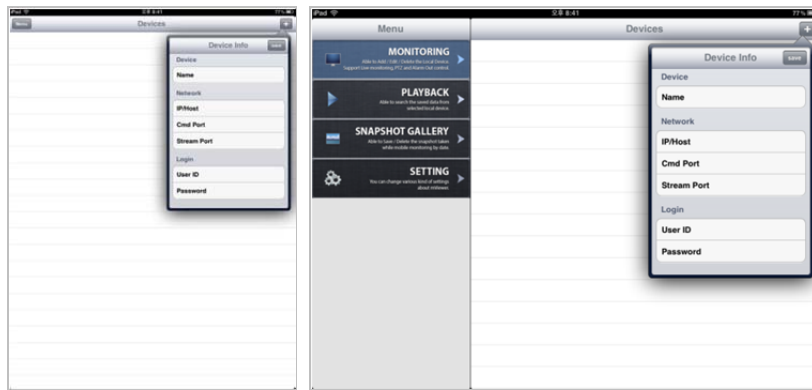

- Tap “” and enter site information which are same as CMS site registration.



- Enter Site Name, IP or DDNS address.
- Enter Admin/Stream port value.
- Enter ID/Password.
- Click “” to save the setting.
- To edit the saved site, tap “” next to site Name, then change the value, and tap “”.
- To delete the saved site, slide the finger from right to left across Device Name. Then tap “” to remove the site.

10.2.4 Connection

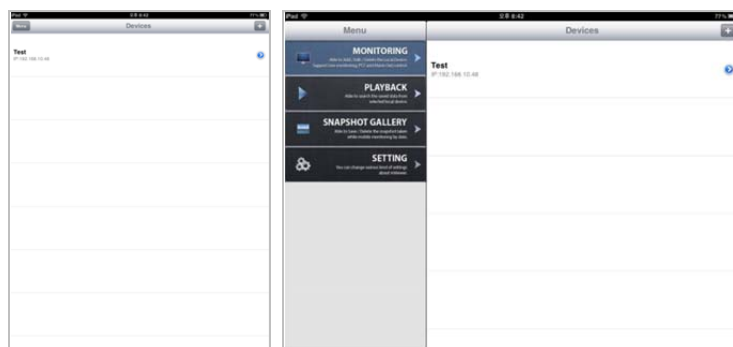



- Tap on Device Name to connect the DVR to iPad.

10.2.5 Live View (Portrait View)

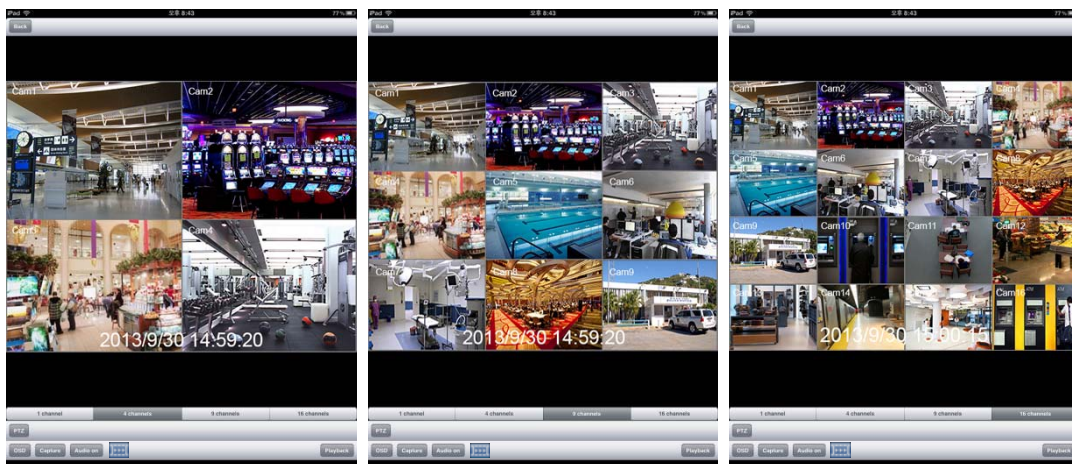

- To select other channels,
 - Slide finger from Right to Left to ascend.
 - Slide finger from Left to Right to descend.
- Tap on “ 1 channel 4 channels 9 channels 16 channels ” to choose split mode between 1, 4, 9 and 16.
 - In Multi-channel display mode, user can double tap on certain channel to change to 1CH display mode.



- Tap “ Capture ” to take Snapshot.
- Tap “  ” to enable Frame Skip.
- Tap “ PTZ ” to enable PTZ function. Please refer to 10.2.7 PTZ Control for more detail.
- Tap “ OSD ” to remove Camera Name and Date/Time from OSD.
- Tap “ Playback ” to switch from Live mode to Playback mode.
- Tap “ Audio on ” to enable audio. (1CH display ONLY)
- Tap “ Audio off ” to disable audio. (1CH display ONLY)
- To use Zoom feature, simply pinch and drag in 1CH display. (1CH display ONLY)

NOTE









Audio, Zoom and PTZ are available only in full screen mode.(1channel only)

NOTE

If user enable frame skip, used memories will be stable and It's possible to use it on live mode and playback mode.

10.2.6 Live View (Landscape View)



- To select other channels,
 - Slide finger from Right to Left to ascend.
 - Slide finger from Left to Right to descend.
- Tap on “   ” to choose split mode between 1, 4, 9 and 16.
 - In Multi-channel display mode, user can double tap on certain channel to change to 1CH display mode.
- Tap “” to go back to main menu.
- Tap “” to enable PTZ function. Please refer to 10.2.7 PTZ Control for more detail.
- Tap “” to take Snapshot.
- Tap “” to enable audio. (1CH display ONLY)
- To use Zoom feature, simply pinch and drag in 1CH display. (1CH display ONLY)

NOTE

Audio, Zoom and PTZ are available only in full screen mode.(1channel only)

10.2.7 PTZ Control

- Users are able to control PTZ with iPad by touching the screen.
- Tap “” to execute PTZ function.



- Tap Arrow for Pan and Tilt movement.
- Touch “” to zoom out.

- Touch “” to zoom in.

- If users already set up the presets on DVR, users may use them by touching “”.

10.2.8 Search

- Users are able to search the recorded data with iPad.
- Click “**PLAYBACK**” on Main menu or “” on Live monitoring to use search function.

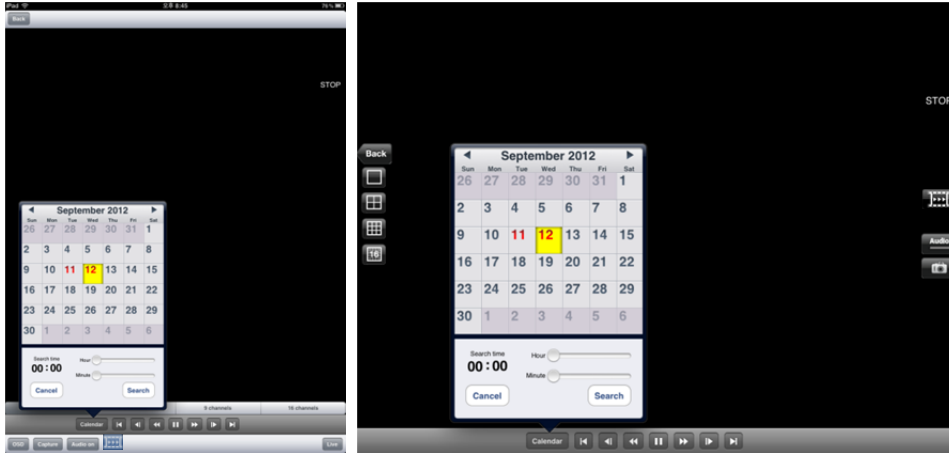



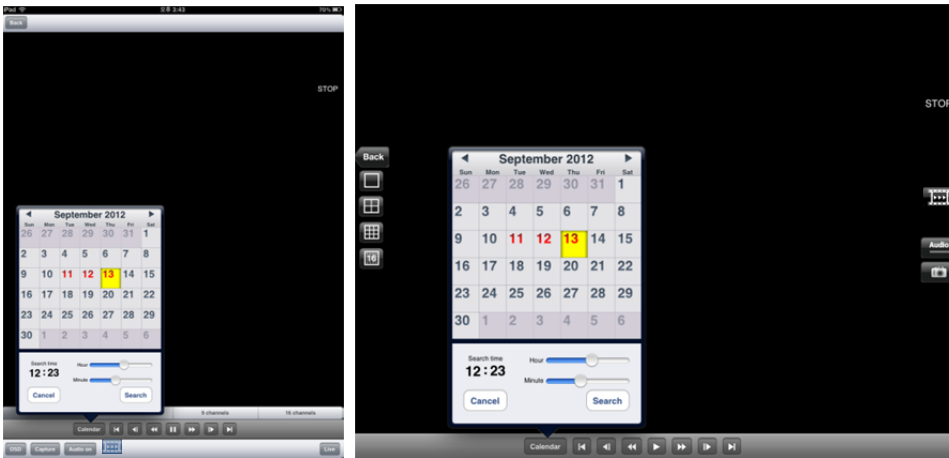



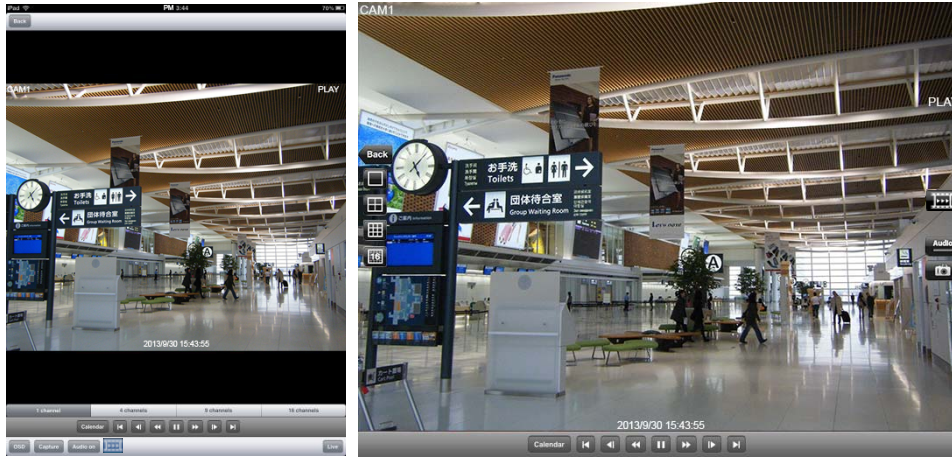









- Choose date that wish to search from Calendar



- Choose time that wish to search by sliding the Hour and Minute bar.
- Tap “” to execute search.



- To select other channels,
 - Slide finger from Right to Left to ascend
 - Slide finger from Left to Right to descend.
- Tap on “ 1 channel | 4 channels | 9 channels | 16 channels ” or “     ” to choose split mode between 1, 4, 9 and 16.
 - In Multi-channel display mode, user can double tap on certain channel to change to 1CH display mode.
- Tap “      ” to control the playback.
- Tap “  ” or “  ” to take Snapshot.
- Tap “  ” or tap screen to remove Camera Name and Date/Time from OSD.
- Tap “  ” to switch from Live mode to Playback mode.
- Tap “  ” or “  ” to enable audio. (1CH display ONLY)
- Tap “  ” or “  ” to disable audio. (1CH display ONLY)
- To use Zoom feature, simply pinch and drag in 1CH display. (1CH display ONLY)

NOTE

Audio and Zoom are available only in full screen mode.(1channel only)

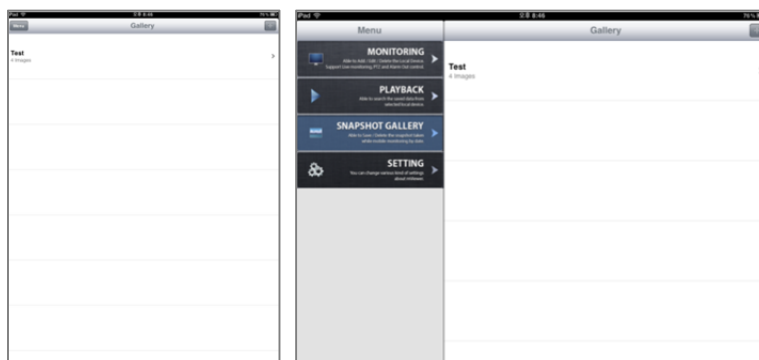

10.2.9 Snapshot gallery

- Users are able to watch the snapshot taken with mViewer while Live monitoring and Playback.
- Tap “Snapshot gallery” from main menu.

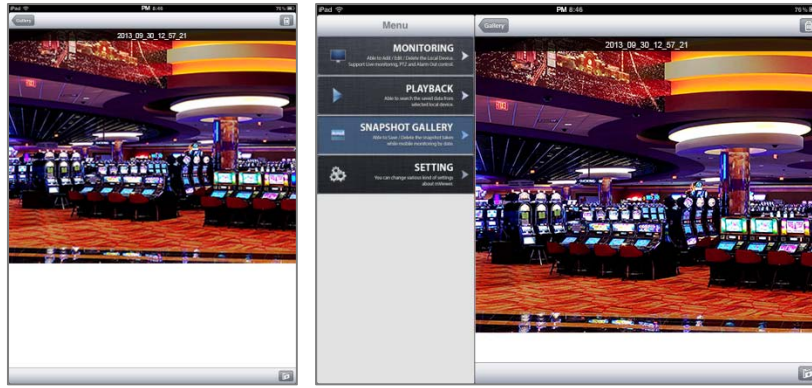

- Select the device and snapshot taken from the selected device will appear.



- To see other pictures slide finger across the screen.
- Tap “” to send the snapshot to the Photos.
- Tap “” to delete the selected snapshot.

10.2.10 Setting

- **Setting** Tap “**SETTING**” to check the information of the application.
- User can read the manual.

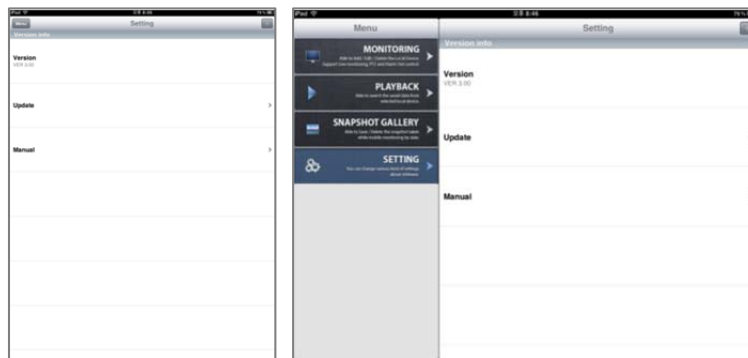

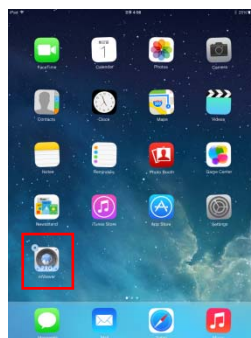

10.2.11 Uninstallation

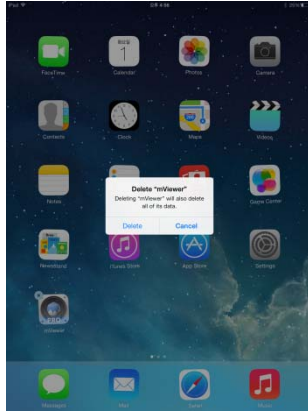

- Click the “” icon and hold for a while until the program icon shows x mark on the top-left side.



- Click the “” icon then it will ask to delete the program.
- Click “” button to successfully uninstall the program.

10.3 Android Phone (mViewer Pro)

10.3.1 System Requirements

- This program is designed and applied only for Android OS (version 2.3 or higher) based mobile device.
- Display: Min. 3.7 inch screen

NOTE

mViewer Pro might not work even though Android OS version is high enough. It is due to the hardware specification of Android device.

10.3.2 Installation

- Turn on the mobile device then connect to Play Store.
- Move to search menu and type “mViewerpro” then select “” program which is offered from dvrdomain by free.

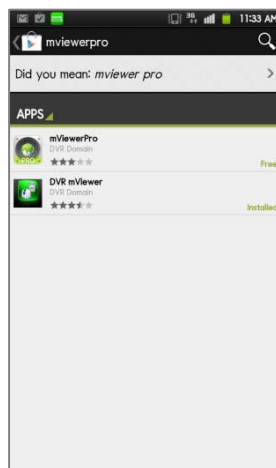

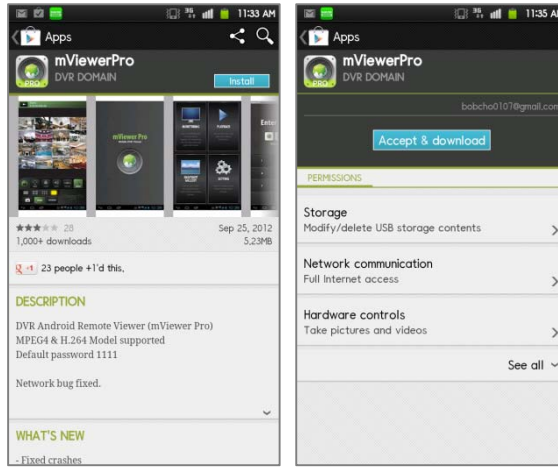

- Click “” then “” to start installation.

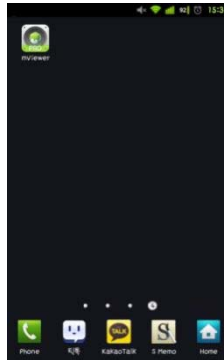

- The program will be automatically installed in user's application menu.



10.3.3 Site Registration

- Click “” icon on application menu then below will show.
- Tap “**MONITORING**” on the main menu.
- Tap “” on top right corner.

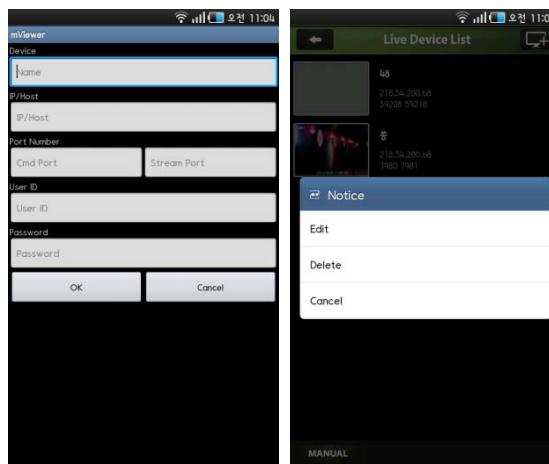

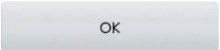
- Enter Device Name, IP/Host address.
- Enter Cmd/Stream port value.
- Enter User ID/Password.
- Click “” to save the setting.

- To edit or delete the saved site, press the Device Name for 2 sec from Live Device List and popup menu will appear.

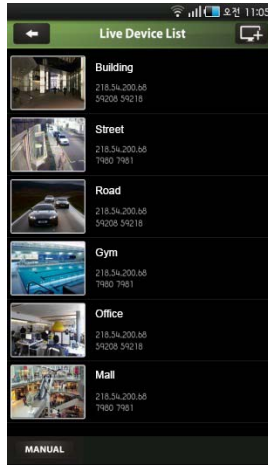

10.3.4 Connection





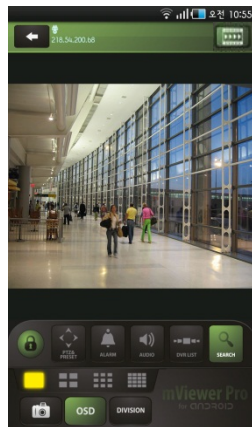







- Tap on Device Name to connect the DVR to mobile device.

10.3.5 Live View (Portrait View)



- To select other channels,
 - Slide finger from Right to Left to ascend.
 - Slide finger from Left to Right to descend.
- Tap on “” or “” to choose split mode between 1, 4, 9 and 16.
 - In Multi-channel display mode, user can double tap on certain channel to change to 1CH display mode.



- Tap “” to enable Landscape view when the device is tilted
- Tap “” to enable Frame Skip.
- Tap “” to enable PTZ function. Please refer to 10.3.7 PTZ Control for more detail.
- Tap “” to enable Alarm Out control. Please refer to 10.3.8 Alarm Out Control for more detail.
- Tap “” to enable audio.
- Tap “” to change to other Device if there is any.
- Tap “” to switch to Search mode.
- Tap “” to take Snapshot.
 - Enter file name and press “” to save the image.
- Tap “” to remove Camera Name and Date/Time from OSD.

NOTE

Audio and Alarm Out are available only in full screen mode.(1channel only)

NOTE

If user enable frame skip, used memories will be stable and It's possible to use it on live mode and playback mode.

10.3.6 Live view (Landscape View)

- Tap “” to enable landscape view when the device is tilted horizontally.

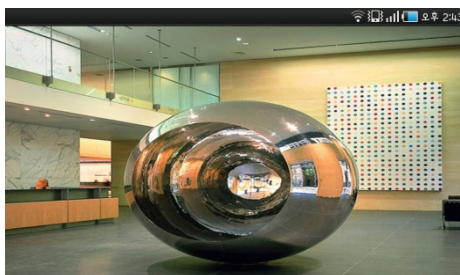

- Tap screen once and menu bar will appear on each side of OSD.

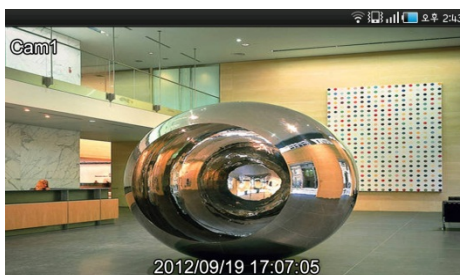

- To select other channels,
 - Slide finger from Right to Left to ascend.
 - Slide finger from Left to Right to descend.



- Tap on “1 Channel 4 Channel 9 Channel 16 Channel” to choose split mode between 1, 4, 9 and 16.
- In Multi-channel display mode, user can double tap on certain channel to change to 1CH display mode.

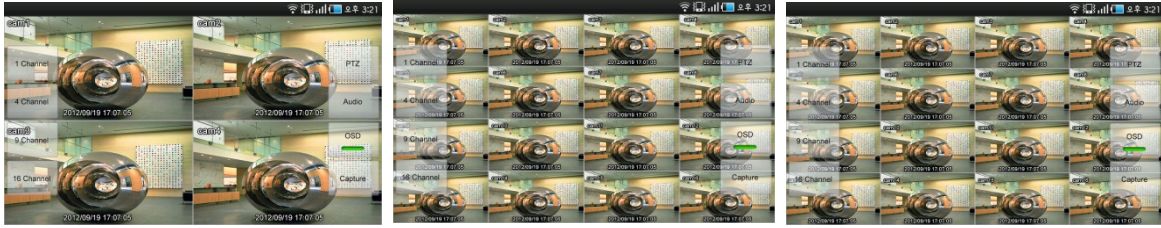

- Tap “PTZ” to enable PTZ function. Please refer to 10.3.7 PTZ Control for more detail.
- Tap “Audio” to enable audio.
- Tap “OSD” to remove Camera Name and Date/Time from OSD.
- Tap “Capture” to take Snapshot.
- Enter file name and press “Save” to save the image.

NOTE

Audio is available only in full screen mode.(1channel only)

10.3.7 PTZ control

- Users are able to control PTZ with mobile device by touching the screen.
- Tap “PTZ PRESET” or “PTZ” to execute PTZ function.

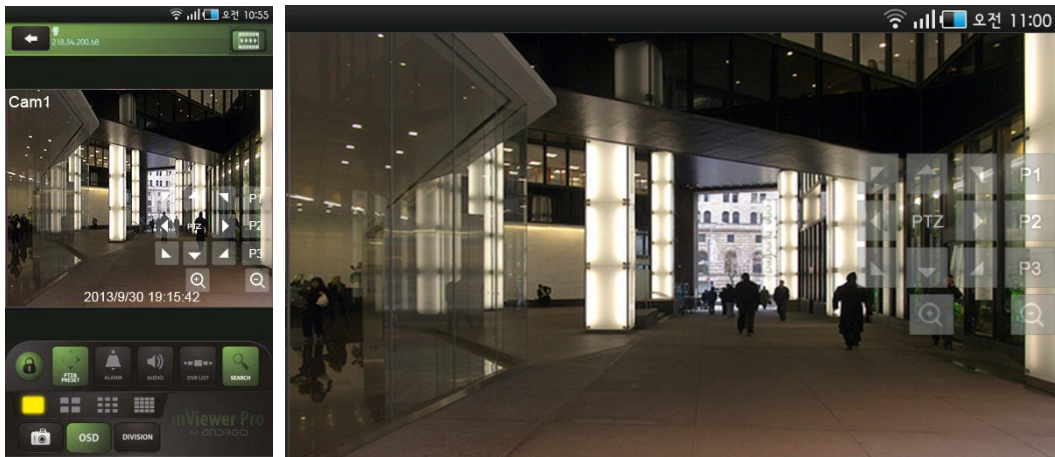

- Tap Arrow for Pan and Tilt movement.
- Touch “Zoom Out” to zoom out.
- Touch “Zoom In” to zoom in.
- If users already set up the presets on DVR, users may use them by touching “P1 P2 P3”.

10.3.8 Alarm Out Control

- Users are able to manually send Alarm out command with the mobile device.
- Tap “” to enable the Alarm Out control and it will appear on lower left corner of Live screen.

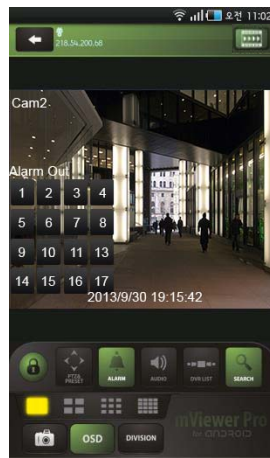

- Tap the numbers to send out Alarm from the connected DVR to its output source.



















10.3.9 Search

- Users are able to search the recorded data with mobile device.
- Tap “PLAYBACK” on main menu or “” on Live monitoring to use search function.



- Choose date and time that wish to search from Calendar
- Tap “” to execute search.



- To select other channels,
 - Slide finger from Right to Left to ascend.
 - Slide finger from Left to Right to descend.
- Tap on " or " or " " " " " to choose split mode between 1, 4, 9 and 16.
 - In Multi-channel display mode, user can double tap on certain channel to change to 1CH display mode.
- Tap " " to control the playback.
- Tap " " to enable Landscape view when the device is tilted.
- Tap " " to change date/time of Search.
- Tap " " or " " to enable select FF and REW speed from x1, x2, x4, x8, x16 and Extreme.
- Tap " " or " to enable audio.
- Tap " " to change to other Device if there is any.
- Tap " " to switch to Live mode.
- Tap " " or " " to take Snapshot.
 - Enter file name and press " " to save the image.
- Tap " " or " " to remove Camera Name and Date/Time from OSD.

NOTE

Audio and Alarm Out are available only in full screen mode.(1channel only)

10.3.10 Snapshot Gallery

- Users are able to watch snapshot with the mobile device.
- Tap " " on main menu to enter the gallery.

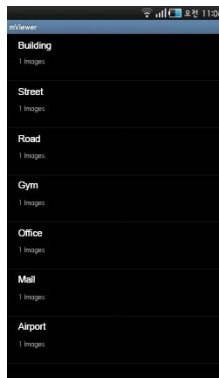

- Tap Device name to view snapshot.
- To see other pictures, slide finger across the screen or touch the thumbnail below.
- To delete the picture/folder,
 - Press the device name for 2-3 seconds till pop-up window appears.
 - Tap "OK" to delete.

10.3.11 Setting

- Tap “**SETTING**” to check the information of the application.
- User can read the manual.
- Users are able to set Password Lock.
 - Tap “Password Lock” from the setting menu.
 - Enter password. (Default password is 1111)



- Tap “” to enable Password Lock when launching the mViewer.
- Tap “change” to change the password.

10.3.12 Uninstallation

- Move to Setup > Application > Manage Applications then select “”.

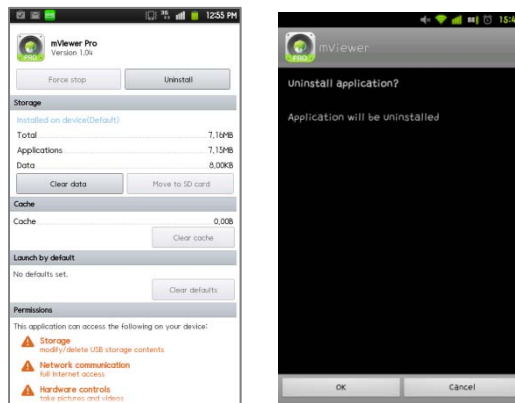

- Click “” icon then it will ask to delete the program.



- Click “” button to successfully uninstall the program.

**Keyboard Controller
CP1300**

User`s Manual



11. KEYBOARD CONTROLLER

11.1 Connection

- User may connect cameras and Keyboard through DVR in various ways.
- Below shows the major probable connection methods through RS-485;

11.1.1 Configuration Diagram

- Example

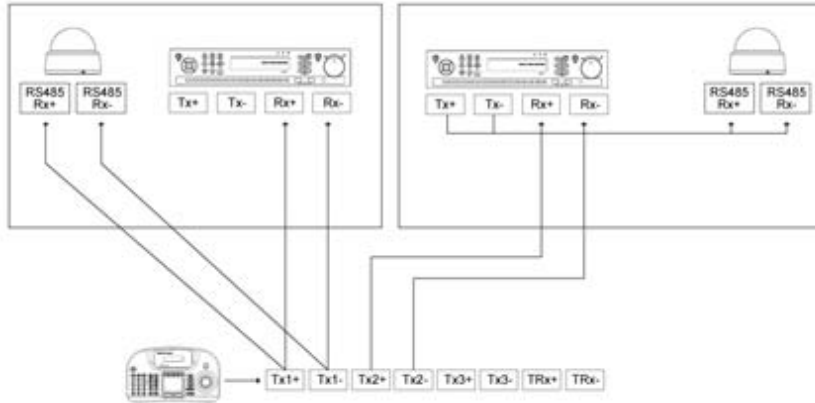

- Please make sure to connect “Tx to Rx “or “Rx to Tx” with same polarity. (+ to +) and (- to -).

11.1.2 USB Connection

- In order to use Touch Pad on CP1300, user must connect CP1300 and DVR with provided USB cable.
- DVR will automatically recognize the Touch Pad.

11.2 Keyboard Setup in DVR

- Enter “Setup>SYSTEM>Information: System ID” and define the ID of DVR.
- When user connects more than two DVRs then each DVR has to have a different ID.

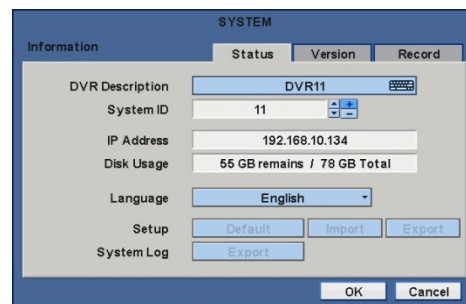
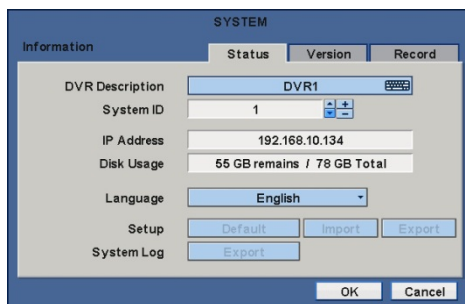



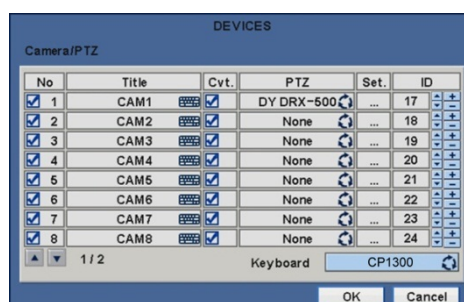



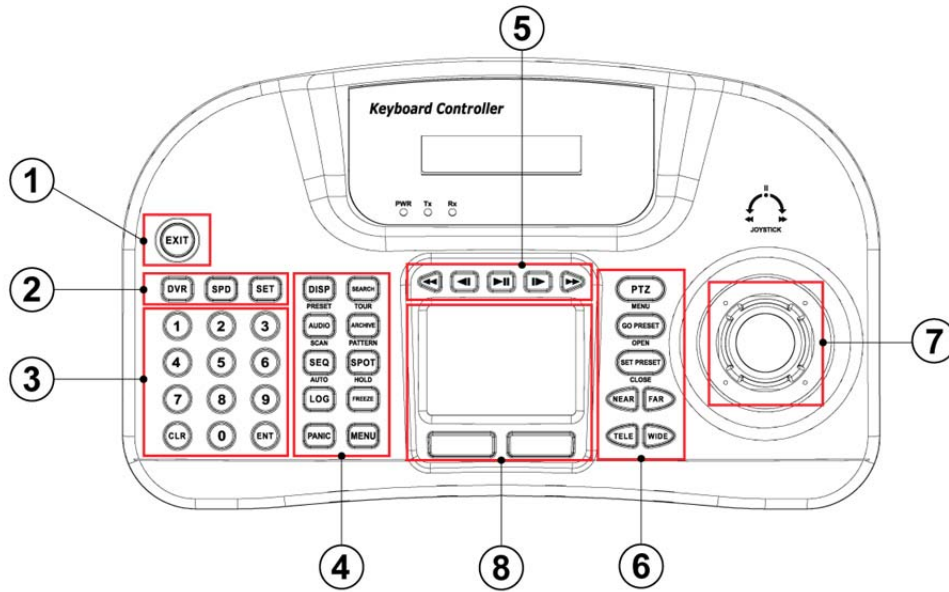





- Then move to “Setup>Device>Camera/PTZ: Keyboard” and select CP1300.
- Then, choose PTZ protocol and Camera ID. (For detailed information on setting PTZ camera, please refer to DVR manual)



11.3 Keyboard Configuration



	KEYS	DVR Mode		SPD mode
		DVR control Mode	PTZ Mode	
①	EXIT	EXIT Key	N/A	N/A
②	DVR	DVR Mode select Key		
	SPD	SPD Mode select Key		
	SET	Setup Key		
③	0 ~ 9	Number Pad Key		
	CLR	Clear Key		
	ENT	ENTER Key		
④	DISP (PRESET)	Display Key	N/A	Preset Key
	AUDIO (SCAN)	Audio Key	N/A	Scan Key
	SEQ (AUTO)	Sequence Key	N/A	Auto Key
	LOG	System Log Key	N/A	N/A
	PANIC	Emergency recording Key	N/A	N/A
	SEARCH (TOUR)	Search Key	N/A	Activate Tour Key
	ARCHIVE (PATTERN)	Archive Key	N/A	Activate Pattern Key
	SPOT (HOLD)	Spot control Key	N/A	Hold Key

		Pause on Live Key	N/A	N/A
		DVR Menu Key	N/A	N/A
⑤		REW Key	N/A	N/A
		Backward Key	N/A	N/A
		Play/Pause Key	N/A	N/A
		Forward Key	N/A	N/A
		FF Key	NA	N/A
⑥		PTZ Mode Key	N/A	Camera Menu Key
		N/A	Activate Preset Key	Open Iris Key
		N/A	Set Preset Key	Close Iris Key
		N/A	Focus control Key	Focus control Key
		N/A	Zoom control Key	Zoom control Key
⑦	JOYSTICK	Direction key	Pan, Tilt, Zoom	
⑧	Touch Pad	Mouse	N/A	

11.4 Setup

11.4.1 DVR Control Mode

- Press **1** + **SET** in DVR Mode to enter Main Setup and enter password. (Default password is 0000)

Keyboard	Detail	Option
VER	Firmware version	-
DATE	Date setting	YY/MM/DD
TITLE SET	Camera title	-
CONTROL ID	ID No. Change	-
DVR SPD	Set Baud rate	2.4Kbps~57.6Kbps
COMM	Communication setting	RS422 / RS485
BACKLIGHT	Backlight setting for LCD	OFF / ON / AUTO
SLEEP	Sleep mode setting	OFF / 1Min / 5Min / 10Min / 30Min / 1 Hr
BUZZER	Buzzer setting	OFF / ON
TERMINATE	Termination	OFF / ON
JOYSTICK SPD	Joystick speed	50MS~300MS
PASSWORD	Change password	Default password: 0000
FACTORY SET	Factory reset	-
SAVE/EXIT	Save and Exit	NO / YES

11.4.2 Speed Dome Setup

- Press **2** + **SET** in SPD Mode to enter Speed Dome Setup and enter password. (Default password is 0000)

Keyboard	Detail	Option
ADDRESS	Camera ID number	1~255
MODEL	Select Camera	-
PROTOCOL	Set Protocol	PEL-D / PEL-P / W-DRX / SAM-E / LGP / SAM-T / PANAS / VICON / AD / HWELL
BAUDRATE	Set Baud rate	2.4Kbps~57.6Kbps
PARITY	Set Parity	NONE / EVEN / ODD
PROP	Set Camera speed	Slow PTZ => PROP: ON Speed PTZ => PROP: OFF

11.4.3 Joystick Calibration

- Press **3** + **SET** to enter Joystick Calibration and enter password. (Default password is 0000)

Keyboard	Detail	Option
PTZ OFFSET	Rest position value setting	-
PAN LEFT	Left Pan value setting	-
PAN RIGHT	Right Pan value setting	-
TILT UP	Tilt Up value setting	-
TILT DOWN	Tilt Down value setting	-
ZOOM WIDE	Zoom Wide value setting	-
ZOOM TELE	Zoom Tele value setting	-

11.5 Operation

11.5.1 DVR/SPD Mode Conversion

- Press "System ID" + "**DVR**" to enter DVR control Mode.
- Press "Speed Dome Camera ID" + "**SPD**" to enter PTZ camera control Mode.

Example

- If user wishes to connect to SYSTEM ID 3 DVR then press Num Pad "**3**" + "**DVR**".
- If user wishes to connect to Speed Dome camera ID 3 then press Num Pad "**3**" + "**SPD**".

11.5.2 DVR Control Mode

11.5.2.1 Connection

- If the DVR Control Mode is selected followings will appear on Keyboard LCD and Live OSD as "**KBD:#**" on the right-bottom corner.

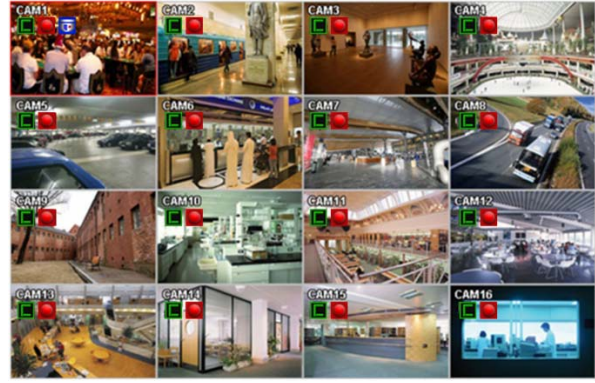

- Then, user should be able to operate the DVR functions by CP1300.

11.5.2.2 Buttons

- In DVR control mode, all buttons are operated according to texts written on each button. The functions are same as Front buttons of DVR as follows:

- **DISP** : Change display mode on Live and Playback in sequence of 1CH>4CH>9CH>16CH>1CH.
- **AUDIO** : Activates and the AUDIO function and change Audio channel
- **SEQ** : Turn on/off Sequence function. Only supports 1CH, 4CH, 9Ch display mode
- **LOG** : Pop up System Log
- **PANIC** : Active Emergency recording.
- **SEARCH** : Pop up Search Menu in Live or switches to Live in Playback mode.
- **ARCHIVE** : Pop up Archive window.
- **SPOT** : Change the channel of a monitor connected to the Spot output.
- **FREEZE** : Freeze a current image in Live mode ONLY.
- **MENU** : Pop up Setup window.
- **PTZ** : Enter PTZ control mode and able to use PTZ function of DVR.
- : Playback control in DVR Search Mode.
- **ENT** : View a channel in full screen (by selecting a number with ENTER button).

NOTE

- For detailed information on PTZ Mode, please refer to 1.5.2.3 PTZ Mode.

11.5.2.3 PTZ Mode

- In order to enter PTZ mode, press “Camera ID” + “ **PTZ** “.

NOTE

- PTZ Mode only can be switched from DVR Mode.

- If the PTZ Mode is selected following will appear on Keyboard LCD and OSD



- Then, user should be able to operate the PTZ camera with CP1300.
- In PTZ mode, all buttons are operated according to texts written on each button. The functions are same as Front buttons of DVR as follows:
 - # + " **GO PRESET** " will move to saved Preset point.
 - # + " **SET PRESET** " will save new Preset point under #.
 - Press " **NEAR** " **FAR** " to adjust the Focus.
 - Press " **TELE** " **WIDE** " to activate the Zoom.

WARNING

- Depending on the Protocol being used by the Speed Dome camera, controlling camera menu will differ. Please check Speed Dome camera manual.

11.5.3 SPD Control Mode (Speed Dome)

11.5.3.1 Connection

- If the SPD Control Mode is selected followings will appear on Keyboard LCD:









- Then, user should be able to operate the Speed Dome camera directly with CP1300.

NOTE

- Please check Protocol and Baud rate before operating the Speed Dome Camera using CP1300.

11.5.3.2 Buttons

- **DISP** (**PRESET**): Press number Key and PRESET then the camera will move to designated point.
- **ARCHIVE** (**PATTERN**): Press number Key and PATTERN then the designated Pattern will run
- **SEQ** (**AUTO**): Press number Key and AUTO then the designated Auto will run.
- **SEARCH** (**TOUR**): Press number Key and TOUR then the designated Tour will run.

-  (**SCAN**): Press number Key and SCAN then the designated Scan will run.
-  (**HOLD**): Press HOLD to lock the Keyboard. To unlock user has to input Password. (Default password is 0000)
-   : Press NEAR/FAR to adjust the focus of Speed Dome camera.
-   : Press TELE/WIDE to adjust the zoom of Speed Dome camera.

NOTE

- SPD Control Mode is only supported when Speed Dome Camera is directly connected to CP1300.

WARNING

- Depending on the Protocol being used by the Speed Dome camera, controlling camera menu will differ. Please check Speed Dome camera manual.

NOTE

• **When a Key does not Work after Set up**

- If the communication speed of DVR and CP are not co-related, it may not work. Please make sure the Baud rate of Keyboard sets on 9.6kbps.
- Press the button to enter PTZ mode and switch to DVR mode again.
- Please reboot the DVR.

• **When Tx Blinks Continually on the LED Window**

- If Tx blinks continually without any operation, it may be caused by improper set up of Joystick.
- OFFSET of the Joystick may not appropriately set up.
- Please do Joystick calibration.

Serial In (POS)

User`s Manual

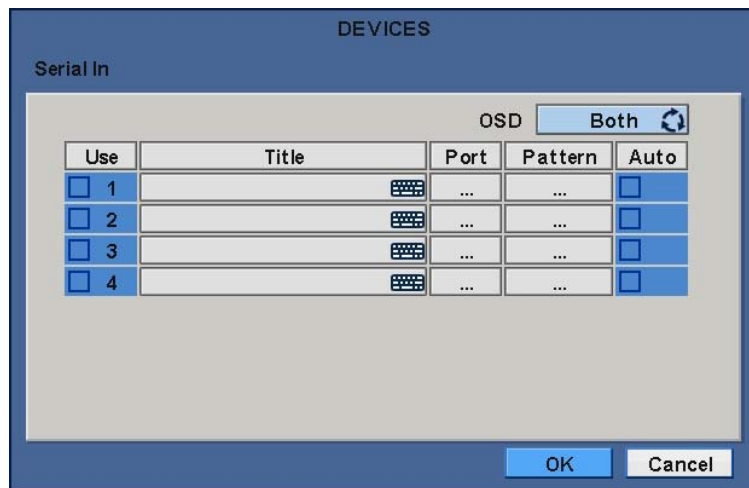

12. SERIAL IN (POS)

12.1 Usage of Serial-In Function

- Enables to record/search/display all transactions on monitoring screen by connecting POS/Cash Register.
- User can choose the data whether to record/display on their taste without limitedly designated protocols.

12.2 Connection Method

- Four ATM/POS channels are available as a default.
- Connect the USB slot of DVR by using USB to RS-232 Converter Cable and it is available to connect up to 4 serial-in devices by using the converter.
- Applicable converters as follows
 - FTDI chipset included converter
 - Prolific PL2303 / PL2303X / PL2303HX chipset included converter
 - Winchiphead chipset included converter
- When using a converter, please connect USB slot of DVR first, then restart in order to the DVR recognizes the USB converter.
- When using a multi-converter, the port recognizes as Number 1 as its shortest line of converter consequently.
- When using both single and multi-converters, single converter is recognized as Port Number 1.

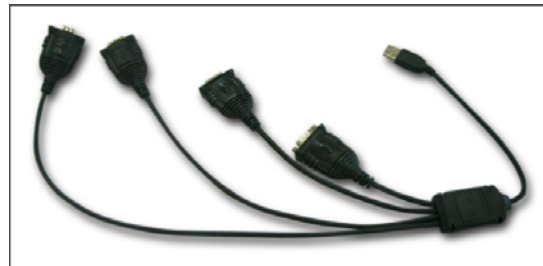
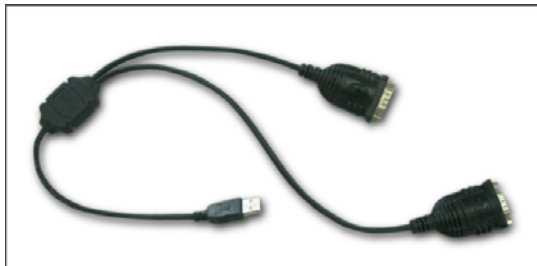

NOTE

It is available to connect 1 Serial-In application without additional option.
This function is only supports English alphabetical characters.
The maximum extension length for RS-232 cable is 15 meters approximately.

12.3 Connection Diagram

- Users can connect RS-232 port to USB port at front/rear of DVR by using a converter.

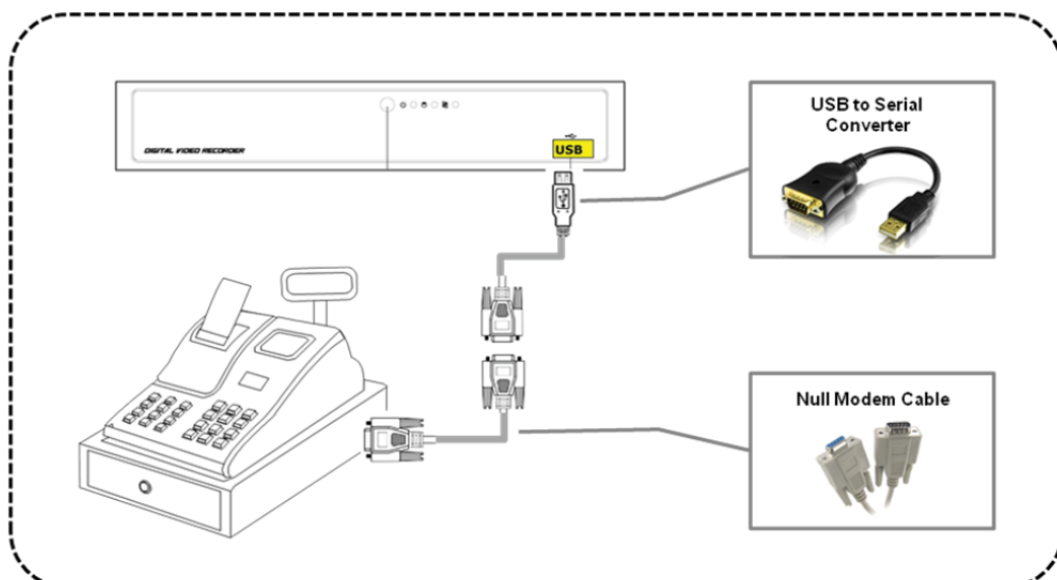

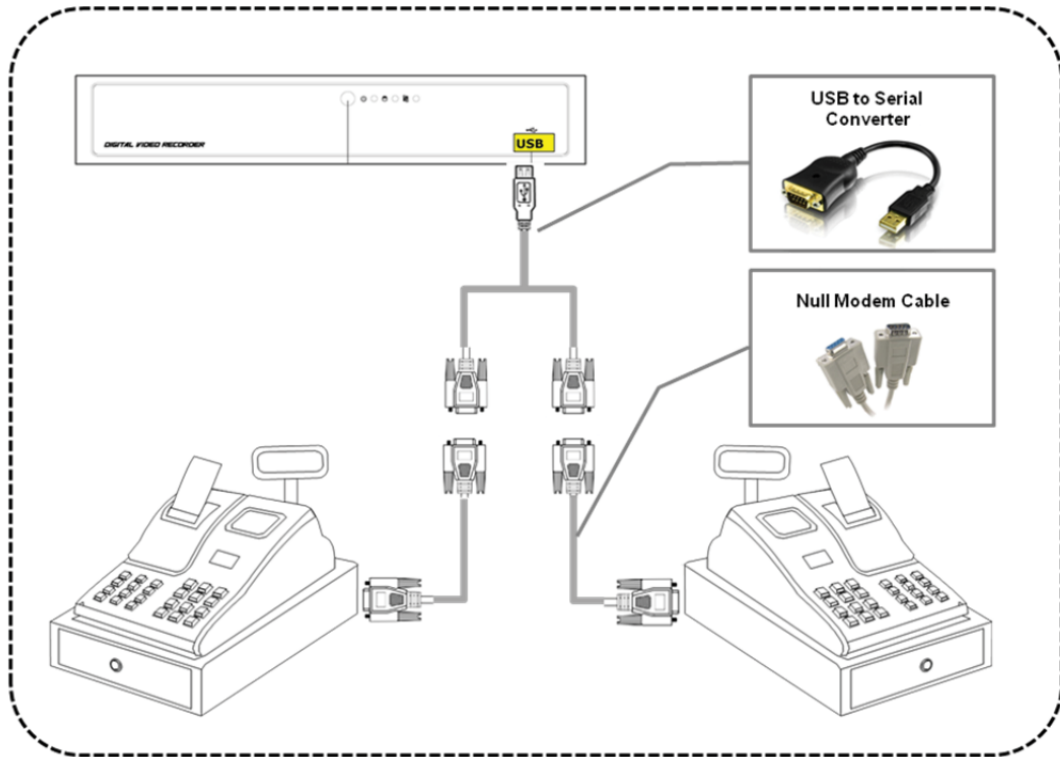

NOTE

- DVR and POS terminals, cabling and installation When you completed, Please restart the DVR.
DVR is "usb to serial cable" to restart the DVR to recognize the device will need to be sure.
- POS terminals to connect to the DVR and Null Modem cable connections.
If you have completed all the configuration and settings, and does not result in state action, RS232c cable's pin in the map, please change the Rx and Tx lines.

Direct connection



Cross connection[Null modem]

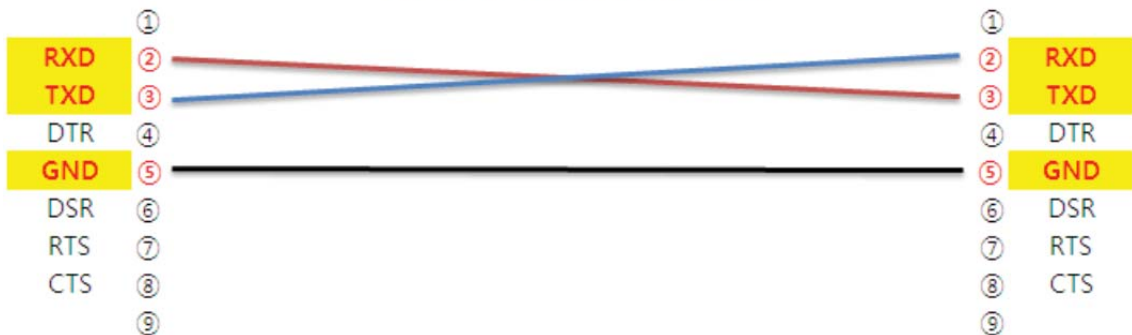

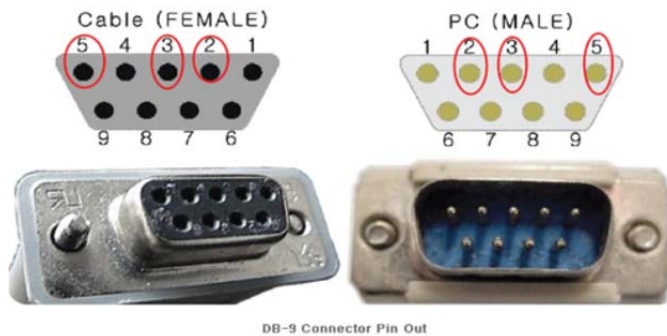

Pin Number	Signal	info
1	CD	Carrier Detect
2	RXD	Receive Data
3	TXD	Transmit Data
4	DTR	Data Terminal Ready
5	GND	Signal Ground /Common
6	DSR	Data Set Ready
7	RTS	Request To send
8	CTS	Clear to send
9	RI	Ring indicator

12.4 Link

12.4.1 Link Setup

- Click "Setup>Link>" then shows as below.

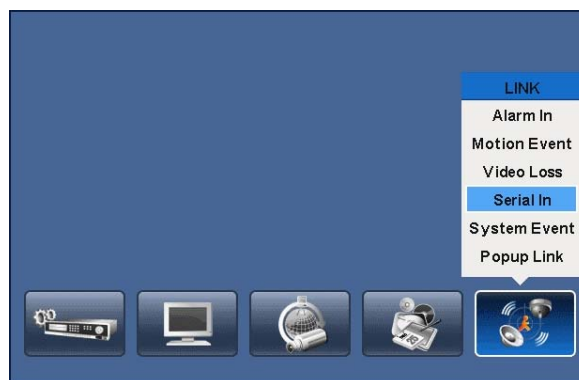

NOTE

The above menu is only available on the DVR model with Serial-In function.

- Click "Serial In" to appear following screen.



- Select POS/ATM port by clicking 'Serial In' button.
- Assign the port to display/record channel by clicking a "Link Camera".
- Select "Link Alarm Out" item to run alarm output when the serial in events occur.
- Designate the E-Mail address or IP/Domain name at "Link Notification" box when the serial in events occur.

NOTE

E-Mail address or IP/Domain configuration is possible to set in 'Setup>Network>Notification' menu.

- Set other POS/ATM port as above.
- Click "OK" to save the configuration.

12.4.2 Schedule Setup

- Click "Record>Schedule>" then shows as below.

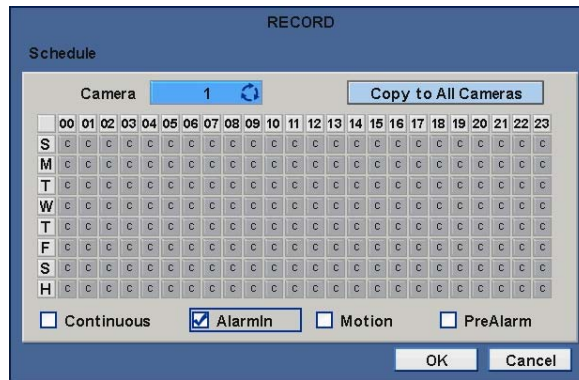

- Tick the box () item Alarm In.
- Click the Time/Date that wishes to activate ATM/POS function on schedule.
- It is possible to activate all the time by clicking top-right side of table.
- Click "OK" to save the schedules.

NOTE

Please do not select the Alarm In and Motion simultaneously on schedule setup. Otherwise, POS/ATM text will be displayed improperly.

12.5 Setup

- Please click (←) "System>Devices>Serial-In", then user will see the display below.

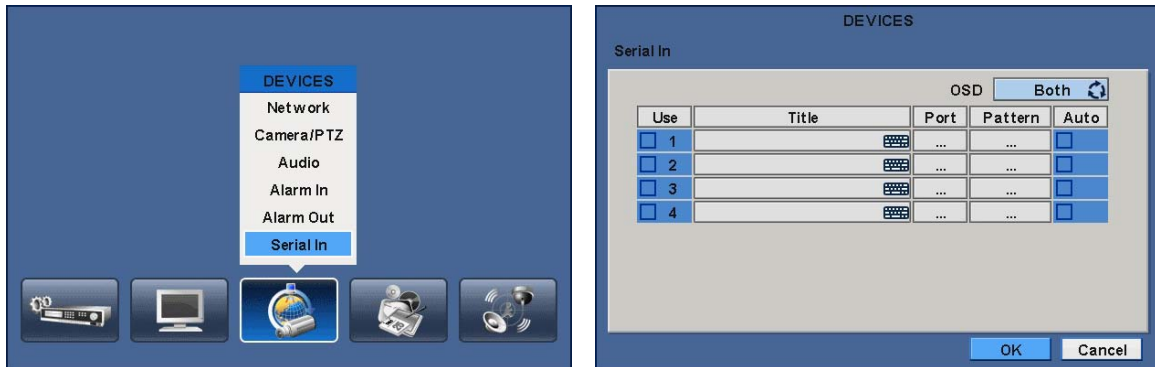

12.5.1 Title

- Click "Title" item then virtual keyboard will appear.
- Input the title then click (←) to save.

12.5.2 Port Setting

- Press (↵) the “Port Setting” button in order to set up the port. Default values are Baud rate 2400 bps, Data Bit 5 bit, Stop Bit 1 bit, Parity None.

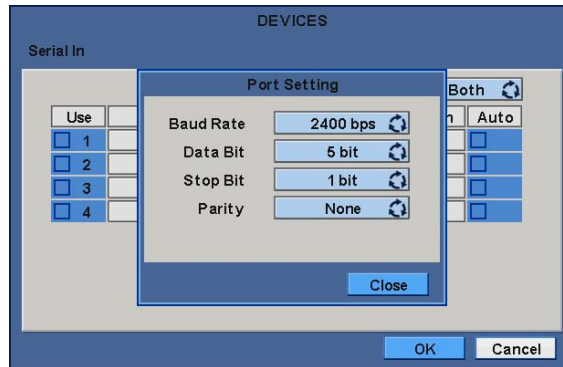

- When the setup is done, press enter (↵) to save the setting.

12.5.3 OSD Display

- OSD items are to decide whether to display the information from the serial port connected to the rs232 port on OSD screen.
- They have 4 menus as followings:
 - None: displays nothing on the OSD screen.
 - Live: displays incoming information from the serial port in real time on the OSD screen.
 - Playback: displays the saved information on the OSD screen during replay.
 - Both: displays all the information on both Live and Playback mode.

12.5.4 Pattern Setting

- User can select the name of serial device if click (↵) the keyboard button of Title.
- When “Use” items of Numbers 1-4 are checked on Serial-In page, it receives the data from the applicable serial device.
- Check the “Auto” item so as to capture automatically all the data which includes unnecessary dummy data out of serial device as below.



- Analyze among the automatically captured data which will be displayed or discarded then enter Pattern Setting.
 - Unless user checks “Auto” item, make sure to set up “Start Pattern” and “End Pattern”
 - “Discard Pattern”, “Line Delimiter” and “MCPL” are utilized independently, not relation to “Auto” mode.
- It is possible to input and analyze the serial data by clicking “Pattern” after tick the “Auto” box (off).

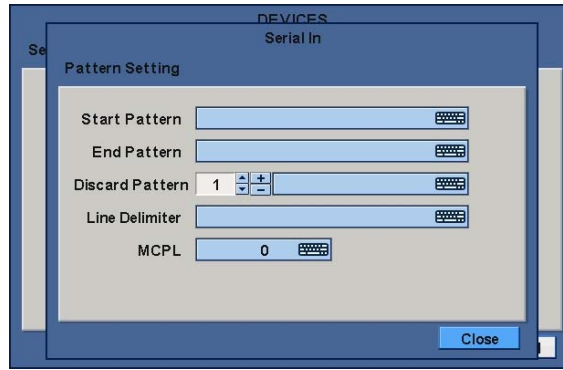

- Each item explains below:
 - Start Pattern: Indicates the beginning of the new data when new designated data are received from a serial device.
 - End Pattern: Indicates the end of the data when designated data are received from a serial device.
 - Discard Pattern: Does not show the designated data on OSD screen. Sets up in order to designate dummy data or characters which is not favorably to be displayed. Can be designated up to 64 of discard patterns in total.
 - Line Delimiter: Inputs characters to be used as delimiter between lines.
 - MCPL (Minimum Character Per Line): Sets up the number of the minimum strings each line. Does not show the characters on OSD screen if there is a character of which number is below the designated number in each line divided by the line delimiter.

Example

- When it firstly connected, the data will be displayed as below.



- Input a certain repeated string to "Line Delimiter".

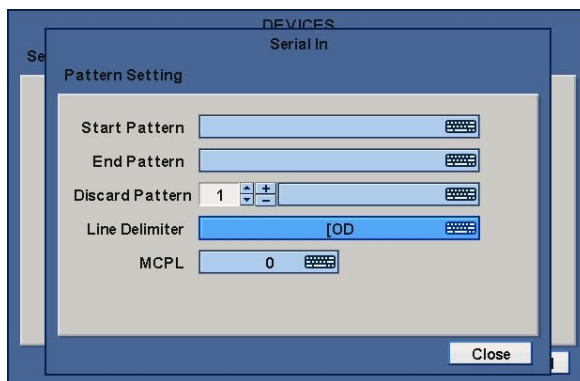

- Decide the number of minimum characters in "MCPL" item to hide data under the designated number of characters.

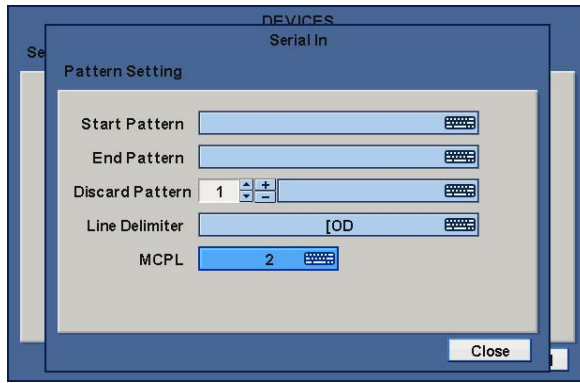

- Input the pattern of dummy data to Discard Pattern.

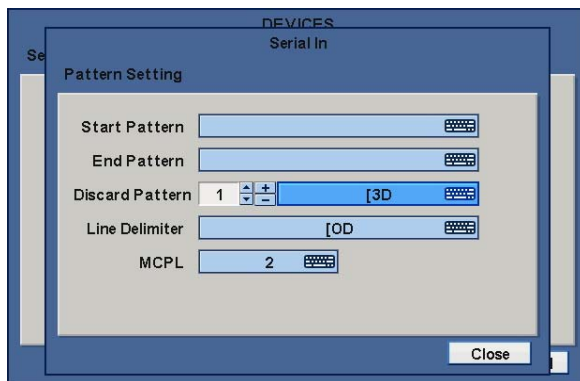

- Choose the data which will be displayed and enter the Start Pattern and End Pattern.

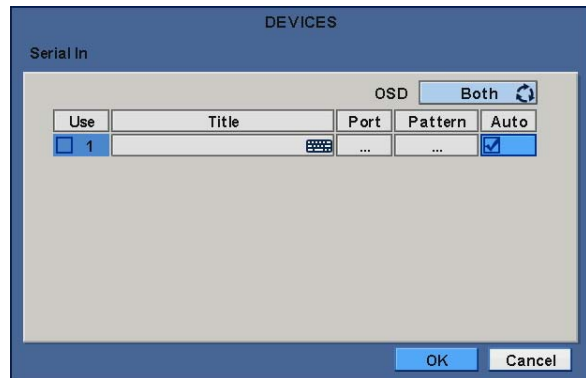
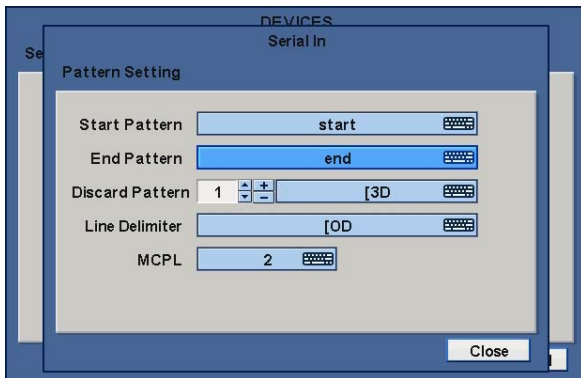

- Then tick the Auto box off in order to make the DVR recognize the data between the Start and End patterns.



- Finally, test again and adjust data to remove missed dummy data.

12.6 Search

- Using event search function.
- Please click (←) the “Search>Event Search” menu on the pop-up menu of the wallpaper, then user will see the following screen.

The screenshot shows a software window titled "Event SEARCH". At the top, it has "From" and "To" date and time fields. Below that, there is a "Camera" dropdown menu and a list of checkboxes for event types: Motion, Alarm In, Emergency, and Serial In (POS/ATM). The "Serial In" checkbox is checked. To the right of these options is a table with two columns: "Time" and "Type". The table contains six rows of data. At the bottom of the window, there are "Search" and "Cancel" buttons, and a "Search Index" button.

From	To
2007/08/02 10:14:53	2007/08/02 13:14:53

Camera	Time	Type
Camera1	2007/08/02 10:44:37	Espresso \$3.25
	2007/08/02 10:45:50	Cappuccino \$4.75
	2007/08/02 10:46:55	Caffe latte \$4.75
	2007/08/02 10:48:10	Americano \$4.00
	2007/08/02 10:55:21	Cappuccino \$4.75
	2007/08/02 11:05:30	Espresso \$3.25
	2007/08/02 12:10:17	Espresso \$3.25

1 / 4





Search Cancel

- It is possible to search the recorded data which is set up on Serial In and Linking pages.
- The keyboard button for setting up the characters to be searched activates only when the Serial In item is checked .

**HD-SDI Video Signal
Accessories**

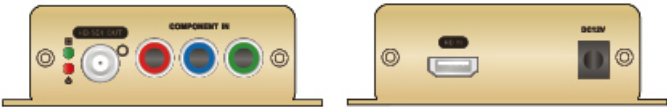
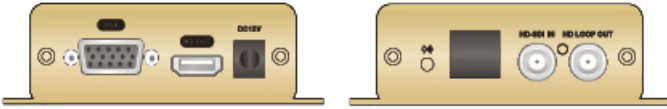
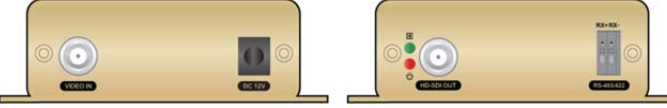
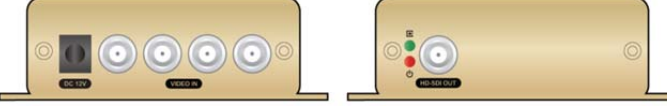
User`s Manual

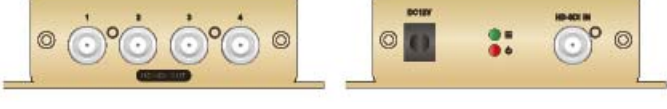
The List of Configuration

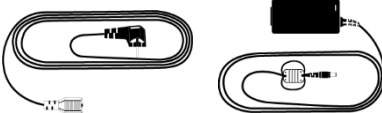
<p>HSC 1100 (HDMI to HD-SDI Converter)</p>	
<p>HSC 1200 (HD-SDI to HDMI Converter)</p>	
<p>HSC 2110 (1 to 1 Analog to HD-SDI Converter)</p>	
<p>HSC 2410 (4 to 1 Analog to HD-SDI Converter)</p>	
<p>HSR 1110 (1 In / 1 Out Repeater)</p>	
<p>HSR 1440 (4 In / 4 Out Repeater)</p>	
<p>HQS 1004 (1 In 4 Out Distributor)</p>	
<p>HFO 1100 (FO to HD-SDI Converter)</p>	
<p>HFO 1200 (HD-SDI to FO Converter)</p>	
<p>Power Adapter and Cable</p>	

13. HD-SDI Video Signal Accessories

13.1 HSC1100

13.1.1 Introduction

- HSC 1100 is HD signal converter which converts video signal between HDMI and HD-SDI. It converts the high resolution of HDMI sources to SMPTE 292M, standard HD-SDI signal.

13.1.2 Features

- Convert HDMI to HD-SDI
- Convert HDMI and component input to HD-SDI SMPTE 292M
- Full HDMI Support Including Embedded Audio
- Equalized HDMI Input Supports Long HDMI Cables Up to 30m, 24 gauge
- HDMI v1.3 Standard
- HD-SDI SMPTE 292M Support(1080p, 1080i or 720p)
- Low Power Consumption: Free Voltage 12VDC, 1A
- Compact Size & Light Weight

13.1.3 Technical Specification

Model	HSC 1100
Input	HDMI
	Component Input
Input Formats	1080p 24/25/30
	1080i 50/60
	720p 50/60
Output	HD-SDI SMPTE 292M
Output Formats	1080p 24/25/30
	1080i 50/60
	720p 50/60
Power Consumption	Free Voltage 12VDC, 1A
Dimension (W*H*D)	83.75mm x 31.75mm x 87.07mm / 3.35inch x 1.27 x 3.48 inch
HDMI Connector	HDMI Female
HD-SDI Connector	BNC Female

13.1.4 Unpacking

- This equipment is an electronic appliance, so it should be handled with special care.

13.1.5 Service

- If there is any problem in the product, please refer to the supplier or the distributor with qualified service personnel.

13.1.6 System Dimension Diagram

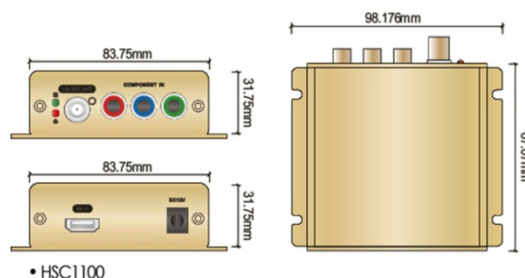

13.1.7 System Connection Diagram

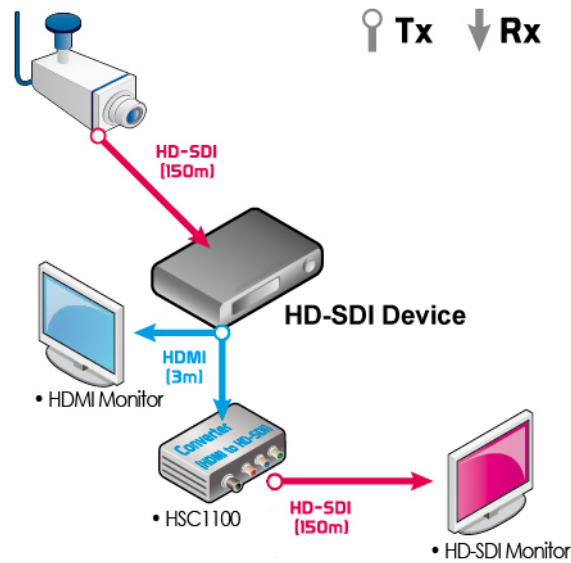

13.1.7.1 HDMI In/Out and HD-SDI In/Out Connections

- Connect a 'HDMI OUT' from the device to 'HDMI IN' of HSC 1100 using by HDMI cable.
- Connect a 'HD-SDI OUT' from HSC 1100 to 'HD-SDI IN' of HD-SDI device using by 75 ohm coaxial cable.

13.1.7.2 Video Component Input

- If users wish to link video component input (e.g. Divx, etc), assure that video component input and "COMPONENT IN" connections are connected properly with same colors.

13.1.7.3 Power Supply Connections

- Plug the power supply adapter (DC 12V, 3.33A) which is included in this product to 'DC12V' connector and plug another side to power source and Input voltage is a free volt (100 VAC ~ 240 VAC).

13.1.8 Cable





- 75 ohm coaxial cable
- HDMI cable
- Component cable

NOTE

The cables above are not included in the package.

13.1.9 Display

13.1.9.1 LEDs

KEYS	Operating mode
Power LED (Red)  	<ul style="list-style-type: none"> • Light off: Converter off • Light on: Converter on
Connection LED (Green)  	<ul style="list-style-type: none"> • Light off: Not connected • Light on: Connected

13.2 HSC1200

13.2.1 Introduction

- HSC 1200 is HD signal converter which converts video signal between HD-SDI and HDMI. It converts the HD-SDI video to HDMI signal.

13.2.2 Features

- Convert HD-SDI to HDMI
- Equalized HDMI input supports long HDMI cables up to 30m, 24 gauge
- HDMI v1.3 standard
- HD-SDI SMPTE 292M support(1080p, 1080i or 720p)
- Free voltage 12VDC, 1A
- Compact Size & Light weight

13.2.3 Technical Specification

Model	HSC 1200
Input	HD-SDI SMPTE 292M
Input Formats	1080p 24/25/30
	1080i 50/60
	720p 50/60
Output	HDMI
	HD-SDI Loop Output
Output Formats	1024 x 768
	720p 60
	1080p 30/60
Power Consumption	Free Voltage 12VDC, 1A
Dimension (W*H*D)	83.75mm x 31.75mm x 87.07mm / 3.35inch x 1.27 x 3.48 inch
HDMI Connector	HDMI Female
HD-SDI Connector	BNC Female

13.2.4 Unpacking

- This equipment is an electronic appliance, so it should be handled with special care.

13.2.5 Service

- If there is any problem in the product, please refer servicing to a supplier or a distributor with qualified service personnel.

13.2.6 System Dimension Diagram

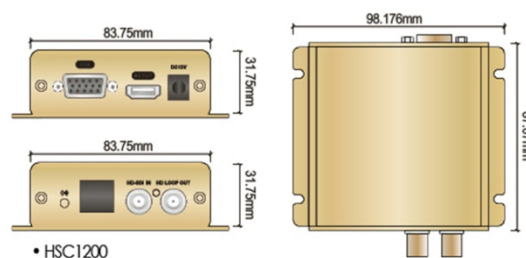

13.2.7 Connector Wiring

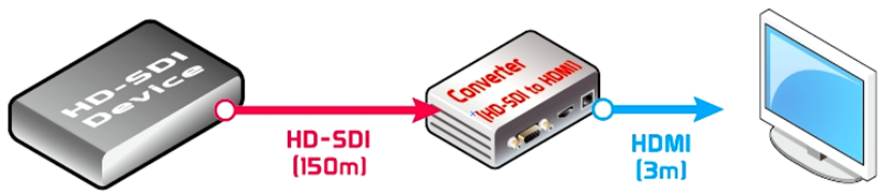

13.2.7.1 HD-SDI In/Out and HDMI In/Out Connections

- Connect a ‘**HD-SDI OUT**’ of HD-SDI device to ‘**HD-SDI IN**’ of HSC 1200 using by 75ohm coaxial cable.
- Connect a ‘**HDMI OUT**’ of HSC 1200 to ‘**HDMI IN**’ of device with HDMI output using by HDMI cable.

13.2.7.2 Video Component Input

- If users wish to link video component input (e.g. Divx, etc), assure that video component input and “**COMPONENT IN**” connections are connected properly with same colors.

13.2.7.3 Power Supply Connections

- Plug the power supply adapter (**DC 12V, 3.33A**) which is included in this product to ‘**DC12V**’ connector and plug another side to power source and Input voltage is a free volt (**100 VAC ~ 240 VAC**).

13.2.8 Cable

- 75 ohm coaxial cable
- HDMI cable
- VGA cable

NOTE

The cables above are not included in the package.

13.2.9 Operation Key and Screen Display Information

First Digit No.	Output resolution
1	OUT_1024x768
2	OUT_1280x720p_60Hz
3	OUT_1920x1080_30Hz
4	OUT_1920x1080_60Hz, (default)
5	OUT_1920x1080_60Hz_RB

NOTE

Operation button: When operation button is pressed, output resolution is changed. Please note that the number shown in the operation button is the time that users need to press the button.

Second Digit No.	Input resolution
-	No input detected
1	IN_1280x720p (max. 60 frames)
2	IN_1920x1080i(50 or 60 field)
3	IN_1920x1080p(30 frame only, doesn't support 60 frame)

NOTE

Input resolution depends on the input signal.

NOTE

Please note that this device has the same function as HD-SDI repeater that extends the signal transmission distance up to 150m.

13.3 HSC2110

13.3.1 Introduction

- HSC 2110 is video signal converter between SD to SDI. It is 1 In / 1 Out SD to SDI signal converter which will convert one analog signal to one HD-SDI signal.

13.3.2 Features

- Convert 1CH SD to 1CH HD-SDI
- NTSC/PAL Input Signal Auto Detection
- Output Signal Format 1080p 30
- Vertical Frequency Auto-Track
- PTZ control with Pelco C supporting PTZ camera
- Free Voltage 12VDC, 1A
- Compact Size & Light Weight

13.3.3 Technical Specification

Model	HSC 2110
Input Signal	Analog Input 75Ω, 1Vp-p/BNC-F, 1CH NTSC or PAL (Auto Detection)
Output Signal	HD-SDI SMPTE 292M
Output Format	1080p 30
Input Return Loss (BNC)	>-15dB, 270 Mb
Output Return Loss (BNC)	>-15dB, 1.5 Gb
Input Impedance (BNC)	75 Ohms +/- 1%
Output Impedance (BNC)	75 Ohms +/- 1%
Power Consumption	Free Voltage 12VDC, 1A
Dimension (W*H*D)	83.5mm x 31.5mm x 86.9mm
HD-SDI Connector	BNC Female

13.3.4 Unpacking

- This equipment is an electronic appliance, so it should be handled with special care.

13.3.5 Service

- If there is any problem in the product, please refer servicing to a supplier or a distributor with qualified service personnel.

13.3.6 System Dimension Diagram

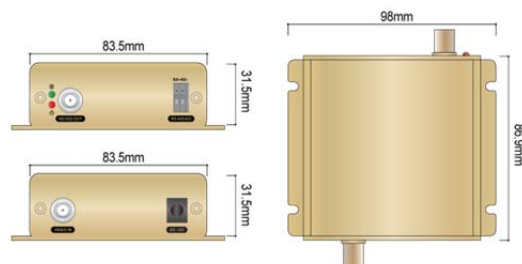

13.3.7 Connector Wiring



13.3.7.1 1 In / 1 Out Analog to HD-SDI Connection

- Connect a 'VIDEO OUT' of analog device to 'VIDEO IN' of HSC 2110 using 75ohm coaxial cable.
- Connect a 'HD-SDI OUT' of HSC 2110 to 'HD-SDI IN' of the HD-SDI DVR using 75ohm coaxial cable.



13.3.7.2 RS-485 Connection

- Connect 'Rx +/-' of the HD-SDI DVR or Keyboard Controller to 'Tx +/-' of HSC 2110.
- Connect 'VIDEO IN' of HSC 2110 to 'VIDEO OUT' of analog PTZ camera using 75ohm coaxial cable.

NOTE

This function is ONLY supported with PTZ camera which supports RS-485 over coax.

NOTE

Please refer to Product Manual 4.4.2 Camera / PTZ for more information.

NOTE

Only support Camera ID 1 in Camera / PTZ Menu.

13.3.7.3 Power Supply Connection

- Plug the power supply adapter (DC 12V, 3.33A) which is included in this product to 'DC12V' connector and plug another side to power source and Input voltage is a free volt (100 VAC ~ 240 VAC).

13.3.8 PTZ Control

- User can control PTZ camera via DVR when connection between DVR, HSC2110 and Camera are properly done.
- For detailed information on Camera/PTZ setup, please refer to Product Manual 4.4.2 Camera / PTZ.

NOTE

This function is ONLY supported with PTZ camera which supports RS-485 over coax.

13.3.9 Cable



- 75 ohm coaxial cable
- RS-485 connection cable.

NOTE

The cable above is not included in the package.

13.3.10 Display

13.3.10.1 LEDs

KEYS	Operating mode
Power LED (Red) 	<ul style="list-style-type: none"> • Light off: Converter off • Light on: Converter on
Connection LED (Green) 	<ul style="list-style-type: none"> • Light off: Not connected • Light on: Connected

13.4 HSC2410

13.4.1 Introduction

- HSC 2410 is video signal converter between SD to SDI. It is 4 In / 1 Out SD to SDI signal converter which will convert four analog signal to one HD-SDI signal.

13.4.2 Features

- Convert 1CH SD to 1CH HD-SDI
- NTSC/PAL Input Signal Auto Detection
- Output Signal Format 1080p 30
- Vertical Frequency Auto-Track
- Free Voltage 12VDC, 1A
- Compact Size & Light Weight

13.4.3 Technical Specification

Model	HSC 2410
Input Signal	Analog Input 75Ω, 1Vp-p/BNC-F, 4CH NTSC or PAL (Auto Detection)
Output Signal	HD-SDI SMPTE 292M
Output Format	1080p 30
Input Return Loss (BNC)	>-15dB, 270 Mb
Output Return Loss (BNC)	>-15dB, 1.5 Gb
Input Impedance (BNC)	75 Ohms +/- 1%
Output Impedance (BNC)	75 Ohms +/- 1%
Power Consumption	Free Voltage 12VDC, 1A
Dimension (W*H*D)	103mm x 31.5mm x 88.09mm
HD-SDI Connector	BNC Female

13.4.4 Unpacking

- This equipment is an electronic appliance, so it should be handled with special care.

13.4.5 Service

- If there is any problem in the product, please refer servicing to a supplier or a distributor with qualified service personnel.

13.4.6 System Dimension Diagram

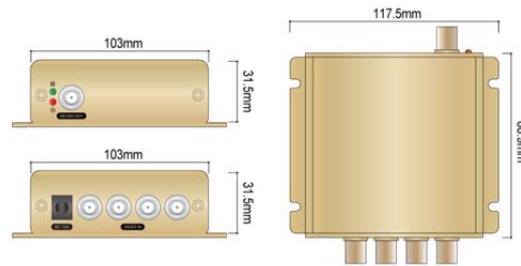

13.4.7 Connector Wiring

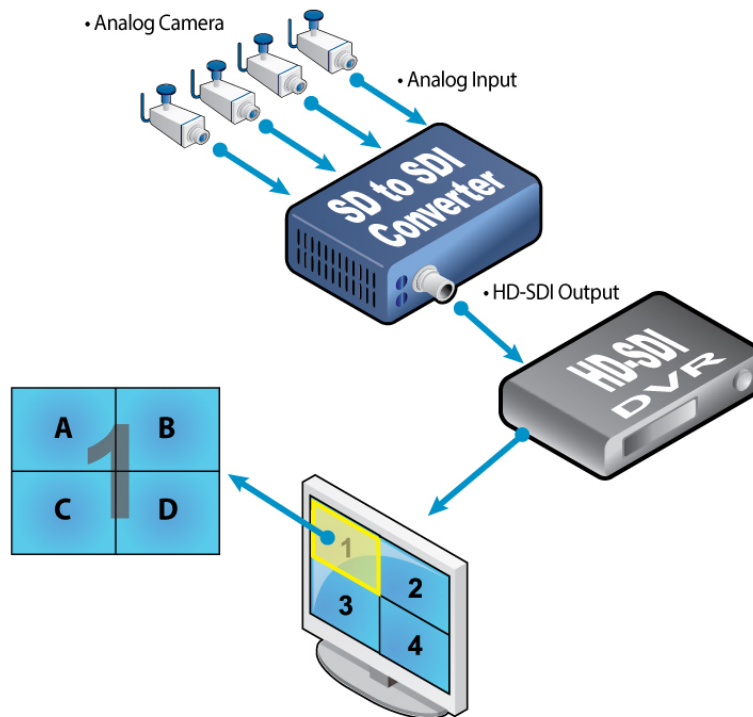

13.4.7.1 4 In / 1 Out Analog to HD-SDI Connection

- Connect 4 'VIDEO OUT' of Analog device to each of 4 'VIDEO IN' of HSC 2410 using 75ohm coaxial cables.
- Connect a 'HD-SDI OUT' of HSC 2410 to 'HD-SDI IN' of the HD-SDI DVR using 75ohm coaxial cable.

13.4.7.2 Power Supply Connection

- Plug the power supply adapter (DC 12V, 3.33A) which is included in this product to 'DC12V' connector and plug another side to power source and Input voltage is a free volt (100 VAC ~ 240 VAC).

13.4.8 Cable



- 75 ohm coaxial cable

NOTE

The cable above is not included in the package.

13.4.9 Display

13.4.9.1 LEDs

KEYS		Operating mode
Power LED (Red)		<ul style="list-style-type: none"> • Light off: Converter off • Light on: Converter on
Connection LED (Green)		<ul style="list-style-type: none"> • Light off: Not connected • Light on: Connected

13.5 HSR1110

13.5.1 Introduction

- HSR 1110 is HD SDI repeater to extend the signal transmission distance between HD-SDI devices. The transmission distance is easily extended up to 150m and if it requires to extend longer than 150m, it needs to connect another repeater to extend the signal transmission and it will be extended up to another 150m.

13.5.2 Features

- 1 in / 1 Out HD-SDI Repeater
- HD-SDI SMPTE 292M support(1080p, 1080i, or 720p)
- 150m Extension of transmission distance
- Vertical Frequency Auto-Track(60,60/1.001)
- Low Power Consumption: Free voltage 12VDC, 1A
- Compact Size & Light weight
- Input / Output return loss : >-15dB at 1.5GBPS
- Input / Output Impedance: 75Ohms+/-1%

13.5.3 Technical Specification

Model	HSR1110
Input / Output Signal	10bit HD Serial Digital Signal, SMPTE 292M, 1/4ch
Video Format	1080p 24/25/30
	1080i 50/60
	720p 24/25/30/50/60
Input Return Loss(BNC)	>-15 dB 270Mb-3Gb
Output Return Loss(BNC)	>-15 dB 270Mb-3Gb
Input Impedance(BNC)	75 Ohms+/-1%
Output Impedance(BNC)	75 Ohms+/-1%
Power Consumption	Free Voltage 12VDC, 1A
Dimension (W*H*D)	83.75mm x 31.75mm x 87.07mm / 3.35inch x 1.27 inch x 3.48 inch
HD-SDI Connector	BNC Female

13.5.4 Unpacking

- This equipment is an electronic appliance, so it should be handled with special care.

13.5.5 Service

- If there is any problem in the product, please refer servicing to a supplier or a distributor with qualified service personnel.

13.5.6 System Dimension Diagram

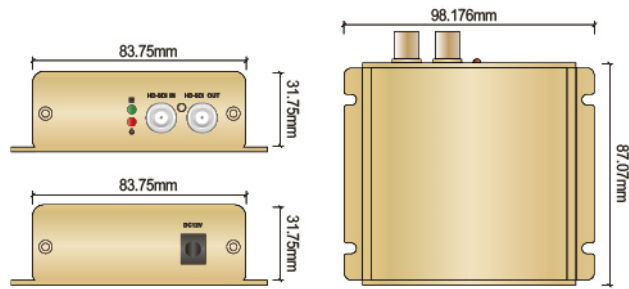

• HSR1110

13.5.7 Connector Wiring



• 1 In / 1 Out HD-SDI Repeater (HSR1110)

13.5.7.1 1 In/ 1 out HD-SDI Connections

- Connect a HD-SDI device (e.g. Camera) to 'HD-SDI IN' of HD-SDI repeater.
- Connect the HD-SDI device (e.g. DVR) to 'HD-SDI OUT' of HD-SDI repeater.

13.5.7.2 Power Supply Connections

- Plug the power supply adapter (**DC 12V, 3.33A**) which is included in this product to '**DC12V**' connector and plug another side to power source and Input voltage is a free volt (**100 VAC ~ 240 VAC**).

13.5.8 Cable





- 75 ohm coaxial cable

NOTE

The cable above is not included in the package.

13.5.9 Display

13.5.9.1 LEDs

KEYS		Operating mode
Power LED (Red)	 	<ul style="list-style-type: none"> • Light off: Repeater off • Light on: Repeater on
Connection LED (Green)	 	<ul style="list-style-type: none"> • Light off: Not connected • Light on: Connected

13.6 HSR1440

13.6.1 Introduction

- HSR 1440 is HD-SDI repeater to extend the signal transmission distance between HD-SDI devices. The transmission distance is easily extended up to 150m and if it requires extending longer than 150m, it needs to connect another repeater to extend the signal transmission and it will be extended up to another 150m.

13.6.2 Features

- 4 In / 4 Out HD-SDI Repeater
- HD-SDI SMPTE 292M Support(1080p,1080i or 720p)
- Vertical Frequency Auto-Track(60,60/1.001)
- Low power Consumption: Free voltage 12VDC, 1A
- Compact Size & Light weight
- Input / Output return loss : >-15dB at 1.5GBPS
- Input / Output Impedance: 75Ohms+/-1%

13.6.3 Technical Specification

Model	HSR1440
Input / Output Signal	10bit HD Serial Digital Signal, SMPTE 292M, 1/4ch
Video Format	1080p 24/25/30
	1080i 50/60
	720p 24/25/30/50/60
Input Return Loss(BNC)	>-15 dB 270Mb-3Gb
Output Return Loss(BNC)	>-15 dB 270Mb-3Gb
Input Impedance(BNC)	75 Ohms+/-1%
Output Impedance(BNC)	75 Ohms+/-1%
Power Consumption	Free Voltage 12VDC, 1A
Dimension (W*H*D)	83.75mm x 31.75mm x 87.07mm / 3.35inch x 1.27 inch x 3.48 inch
HD-SDI Connector	BNC Female

13.6.4 Unpacking

- This equipment is an electronic appliance, so it should be handled with special care.

13.6.5 Service

- If there is any problem in the product, please refer servicing to a supplier or a distributor with qualified service personnel.

13.6.6 System Dimension Diagram

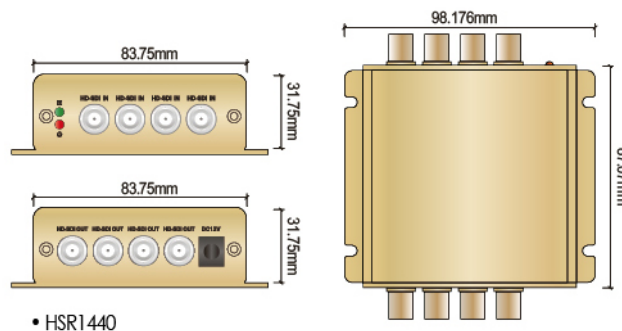

13.6.7 Connector Wiring

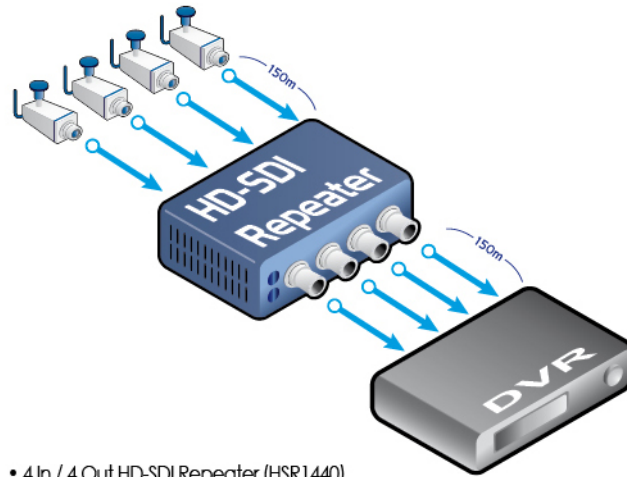

• 4 In / 4 Out HD-SDI Repeater (HSR1440)

13.6.7.1 4 In/ 4 out HD-SDI Connections

- Connect a 4 HD-SDI device (e.g. Camera) to each of 4 'HD-SDI IN' of HD-SDI repeater.
- Connect the 4 HD-SDI devices (e.g. DVR) to each of 4 'HD-SDI OUT' of HD-SDI repeater.

13.6.7.2 Power Supply Connections

- Plug the power supply adapter (**DC 12V, 3.33A**) which is included in this product to '**DC12V**' connector and plug another side to power source and Input voltage is a free volt (**100 VAC ~ 240 VAC**).

13.6.8 Cable





- 75 ohm coaxial cable

NOTE

The cable above is not included in the package.

13.6.9 Display

13.6.9.1 LEDs

KEYS		Operating mode
Power LED (Red)	 	<ul style="list-style-type: none"> • Light off: Repeater off • Light on: Repeater on
Connection LED (Green)	 	<ul style="list-style-type: none"> • Light off: Not connected • Light on: Connected

13.7 HQS1004

13.7.1 Introduction

- This device is HD-SDI Video distribution amplifier which has 4 separately buffered HD-SDI outputs. This model is specially designed for 75 ohm HD Digital video distribution.

13.7.2 Features

- Compact HD-SDI Video Distribution Amplifier
- 1 HD-SDI Video Input(SMPTE 292M)
- 4 Separately Buffered HD-SDI Outputs(SMPTE 292M)
- Auto Equalization
- Auto Re-clock/ Bypass Any Rate from 10KBPS through 2.97GBPS
- Low Power Consumption: Free Voltage 12VDC, 1A
- Compact Size & Light Weight
- Input / Output Return Loss : >-15 dB

13.7.3 Technical Specification

Model	HQS 1004
Format	1080p, 1080i or 720p Manual Selection
Video Inputs	1 HD-SDI Input(SMPTE 292M)
Input Format	1080p 24/25/30
	1080i 50/60
	720p 24/25/30/50/60
Video Output	4 HD-SDI output (SMPTE 292M)
Output Format	1080p 24/25/30
	1080i 50/60
	720p 24/25/30/50/60
Input / Output Return Loss(BNC)	>-15dB, 270Mb-3Gb
Input / Output Impedance	75Ohms+/-1%
Power Consumption	Free Voltage 12VDC, 1A
Dimension (W*H*D)	83.75mm x 31.75mm x 87.07mm / 3.35inch x 1.27inch

13.7.4 Unpacking

- This equipment is an electronic appliance, so it should be handled with special care.

13.7.5 Service

- If there is any problem in the product, please refer to the supplier or the distributor with qualified service personnel.

13.7.6 System Dimension Diagram

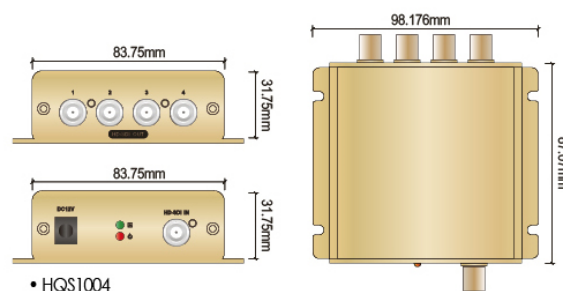

13.7.7 Connector Wiring

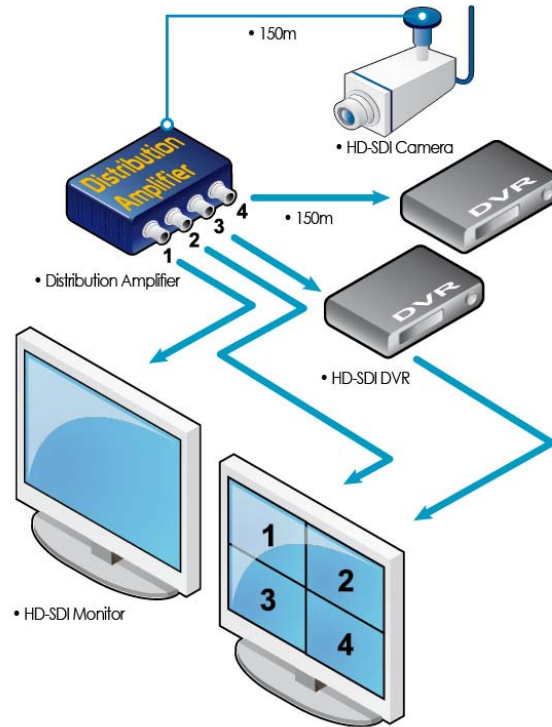

13.7.7.1 Distribution-In/Out Connections

- Connect a 'HD-SDI OUT' of HD-SDI device (e.g. Camera) to 'HD-SDI IN' of HQS 1004 using by 75 ohm coaxial cable
- Connect 4 'HD-SDI OUT' of HQS 1004 to each 'HD-SDI IN' of HD-SDI devices (e.g. DVR).

13.7.7.2 Power Supply Connections

- Plug the power supply adapter (**DC 12V, 3.33A**) which is included in this product to '**DC12V**' connector and plug another side to power source and Input voltage is a free volt (**100 VAC ~ 240 VAC**).

13.7.8 Cable





- 75 ohm coaxial cable

NOTE

The cable above is not included in the package.

13.7.9 Display

13.7.9.1 LEDs

KEYS	Operating mode
Power LED (Red)  	<ul style="list-style-type: none"> • Light off: Repeater off • Light on: Repeater on
Connection LED (Green)  	<ul style="list-style-type: none"> • Light off: Not connected • Light on: Connected

NOTE

Please note that this device has the same function as HD-SDI repeater that extends the signal transmission distance up to 150m.

13.8 HFO1100 & HFO1200

13.8.1 Introduction

- HFO 1100 Series are HD-SDI/Fiber optic converters which enable the transmission of HD-SDI signal up to 30km. These converters meet SMPTE 292M specification and are suitable for both indoor and outdoor use. HFO1200 receives the HD-SDI signal and send the signal out through fiber optic cable. HFO 1100 receives the signal from fiber optic cable and send it out through HD-SDI coaxial cable.

13.8.2 Features

- Transmission of HD-SDI over Single Mode Optical Fiber
- Auto-detection of Video Format
- HD-SDI Connector (SMPTE292M)
- LC Fiber Optic Connector
- Low Power Consumption: Free Voltage 12VDC, 1A
- Input / Output Return Loss : > -15dB at 1.5GBPS
- Input / Output Impedance : 75 Ohms +/- 1%
- All inputs, either SDI or Fiber, are equalized and re-clocked

13.8.3 Technical Specification

Model	HFO1100	HFO1200
Format	3 Gb, 1.5Gb, 270Mb Auto Detect	
Video Inputs	1 LC Fiber Optic Connector 1	HD-SDI Input(SMPTE 292M)
Input Format	1080p 24/25/30	
	1080i 50/60	
	720p 24/25/30/50/60	
Video Outputs	1HD-SDI Output(SMPTE 292M)	1 LC Fiber Optic Connector
Output Format	1080p 24/25/30	
	1080i 50/60	
	720p 24/25/30/50/60	
Cable Equalization (BNC Inputs, 1694 Coax)	270mb, 460m	
	1.5Gb, 230m	
	3Gb, 150m	
Input Return Loss(BNC)	>-15dB, 270Mb-3Gb	
Output Return Loss(BNC)	>-15dB,270Mb-3Gb	
Input Impedance	75Ohms+/-1%	
Output Impedance(BNC)	75Ohms+/-1%	
Optical Outputs	Wavelength:13 10nm	
	Output Power:-2dBm Typical	
Power Consumption	Free Voltage 12VDC, 1A	
Dimension (W*H*D)	83.75mm x 31.75mm x 87.07mm / 3.35inch x 1.27inch	

13.8.4 Unpacking

- This equipment is an electronic appliance, so it should be handled with special care.

13.8.5 Service

- If there is any problem in the product, please refer to the supplier or the distributor with qualified service personnel.

13.8.6 System Dimension Diagram

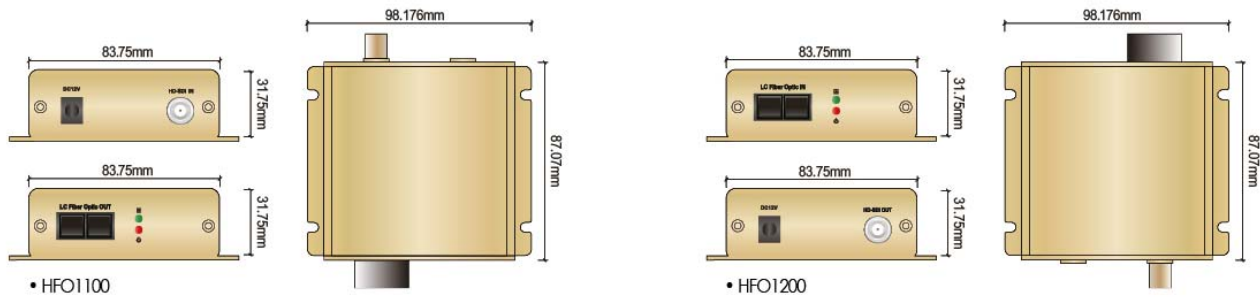

13.8.7 Connector Wiring

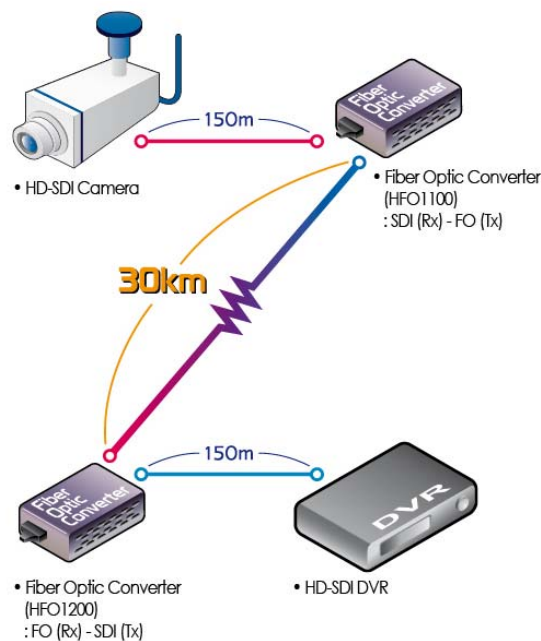

13.8.7.1 HD-SDI in Connections

- Connect HD-SDI Camera to ‘HD-SDI IN’ of HFO1200 using 75 ohm coaxial cable

13.8.7.2 Fiber Optic Out Connections

- Connect the “LC Fiber Optic out” of HFO1200 which can be connected to opposite site of Fiber optic converter (HFO 1100) by using the fiber optic cable.

13.8.7.3 Fiber Optic in Connections

- Connect the fiber optic cable which is coming from the opposite site of HFO1200 to “LC Fiber Optic In” of HFO 1100.

13.8.7.4 HD-SDI out connections

- Connect the ‘HD-SDI OUT’ of HFO 1200 to ‘HD-SDI IN’ of HD-SDI device by using 75ohm coaxial cable.

13.8.7.5 Power Supply Connections

- Plug the power supply adapter (DC 12V, 3.33A) which is included in this product to ‘DC12V’ connector and plug another side to power source and Input voltage is a free volt (100 VAC ~ 240 VAC).

13.8.8 Cable





- 75 ohm coaxial cable is needed
- Fiber Optic Cable

NOTE

The cables above are not included in the package.

13.8.9 Display

13.8.9.1 LEDs

KEYS	Operating mode
Power LED (Red)  	• Light off: Converter off • Light on: Converter on
Connection LED (Green)  	• Light off: Not connected • Light on: Connected