



# E4000

Digital Video Multiplexer/Recorder

This page is intentionally left blank

### CE Information

The product must be installed according to the currently valid installation regulations for EMC to guarantee the designed use and to prevent EMC problems.

The device supplied with this manual is according to the EC, EMC Directive, 89/336/EEC & LVD 73/23/EEC

Standard used for showing compliance with the essential requirements of the device:

EN 55022

EN 61000-3-2

EN 61000-3-3

EN 50130-4

EN 55024

LVD: EN60950-1

## Contents

<b>SAFETY PRECAUTIONS</b> .....	<b>6</b>
<b>CONTENTS OF PACKING</b> .....	<b>7</b>
<b>FEATURES</b> .....	<b>8</b>
<b>FRONT PANEL</b> .....	<b>9</b>
<b>REAR PANEL CONNECTIONS</b> .....	<b>11</b>
<b>SYSTEM CONNECTION DIAGRAM</b> .....	<b>13</b>
<b>ALARM CONNECTIONS</b> .....	<b>14</b>
<b>REMOTE CONTROL</b> .....	<b>15</b>
<b>OSD DESCRIPTION</b> .....	<b>16</b>
<b>MENU TREE</b> .....	<b>17</b>
<b>DEFAULT PASSWORDS</b> .....	<b>19</b>
<b>MENU NAVIGATION</b> .....	<b>20</b>
<b>MENU SETTINGS</b> .....	<b>22</b>
1. DISPLAY .....	22
[ Camera Setting ].....	22
[ Camera Covert ].....	22
[ Camera Name ].....	22
[ Spot Setting ].....	23
[ OSD Setting ].....	24
[ Live Setting ].....	25
2. RECORDING .....	26
[ Global ].....	26
[ Frame ].....	27
[ Event ].....	28
[ Action ].....	29
[ Schedule ].....	30
[ Holiday ].....	31
[ Time ].....	32
[ Duration ].....	32
3. SYSTEM.....	34
[ Basic ].....	34
[ Disk ].....	37
[ Account ].....	38
[ Program Update ].....	40
[ Sensor ].....	41
[ PTZ Setup ].....	41
[ PTZ Controller ].....	42
4. NETWORK .....	47
[ DDNS ].....	47
[ IP SET ].....	48
[ NTP ].....	48
[ LIVE ].....	49
5. EVENT .....	50
[ E-Mail Registration ].....	50
[ SMTP Mode ].....	51
[ E-mail Out ].....	52
[ Beep Out ].....	52
[ Alarm Out ].....	53
<b>SEARCH MENU</b> .....	<b>54</b>
1. SEARCHING VIDEO FOOTAGE.....	54

## E4000 installation and user manual

[ Date / Time Search ].....	54
[ Event ].....	54
[ Calendar Search ].....	55
2. ARCHIVING EVIDENCE TO DVD/CD OR USB.....	57
3. LOG.....	59
<b>CLIENT VIEWER SOFTWARE.....</b>	<b>60</b>
LOGGING ON.....	61
EXPLANATION OF SCREEN BUTTONS.....	62
LIVE MONITORING.....	63
REMOTE SEARCH.....	66
ARCHIVE.....	68
REMOTE LOG.....	71
REMOTE SETUP: (MENU SETTINGS - SAME AS DVR).....	72
1. Display.....	72
2. Recording.....	75
3. System.....	79
4. Network.....	82
5. Event.....	83
LOCAL SEARCH (VIEWING DOWNLOADED FOOTAGE).....	85
Local Setup.....	88
PAN, TILT, ZOOM, FOCUS (REMOTE TELEMETRY CONTROL).....	90
PAN/TILT/ZOOM/FOCUS.....	90
PRESET/LEARN.....	91
FIRMWARE UPGRADE.....	92
Quit (Exiting Client program).....	92
<b>APPENDIX 1.....</b>	<b>93</b>
ALARM SENSOR INSTALLATION.....	93
<b>APPENDIX 2.....</b>	<b>96</b>
DYNAMIC IP (SUPPORTING DDNS SERVER).....	96
<b>APPENDIX 3.....</b>	<b>98</b>
Setup For DVR Port/ Web Server Port Using IP Sharing Router (Port Forwarding).....	98
<b>APPENDIX 4.....</b>	<b>99</b>
SPECIFICATION.....	99

### **Safety Precautions**

#### **Caution Before Use**

Please read this manual before installing or using the Vista Quantum DVR.

Please keep this manual in a safe place, to allow for future reference

For the safety and proper use, The DVR is marked with various symbols. Please read these to prevent injury of financial loss.

#### **Installation Site**

Ensure installation position is level, secure and adequately ventilated.

Avoid installing close to sources of humidity or water.

## **Contents Of Packing**



**User Manual**



**Power Cable**



**Remote Controller**



**Battery**



**Mouse**



**AC Adaptor**

## Features

### • Convenience

- User-friendly GUI (Graphical User Interface)
- Easy-to-use menu structure
- Easy-to-use recorded data search (Time, Date, Motion, and Alarm)
- Easy-to control via Front Panel, IR remote control and USB 2.0 mouse.

### • Stability

- Auto restart after power interruption
- DB structure offers data stabilisation and better storage utilisation

### • Expandability

- Remote DVR's can be controlled using the supplied software client viewer.

### • Technology

- Embedded LINUX OS
- Maximum record rate 400fps(PAL)/ 480fps(NTSC)
- High-resolution & high-quality H.264 algorithm
- Uses watermarking & scrambling technologies,
- H.264 : 1 ~ 2 Kbytes per image with resolution 360x240

### • Functionality

- Variable recording function (normal, alarm, motion, schedule, duration, Time Lapse,)
- RS485 Telemetry
- Full channel real-time monitoring
- Live monitoring, recording, playback, backup, remote access simultaneously
- Multi channel playback
- Variable events notification to e-mail, buzzer or PC Client system



## Front Panel

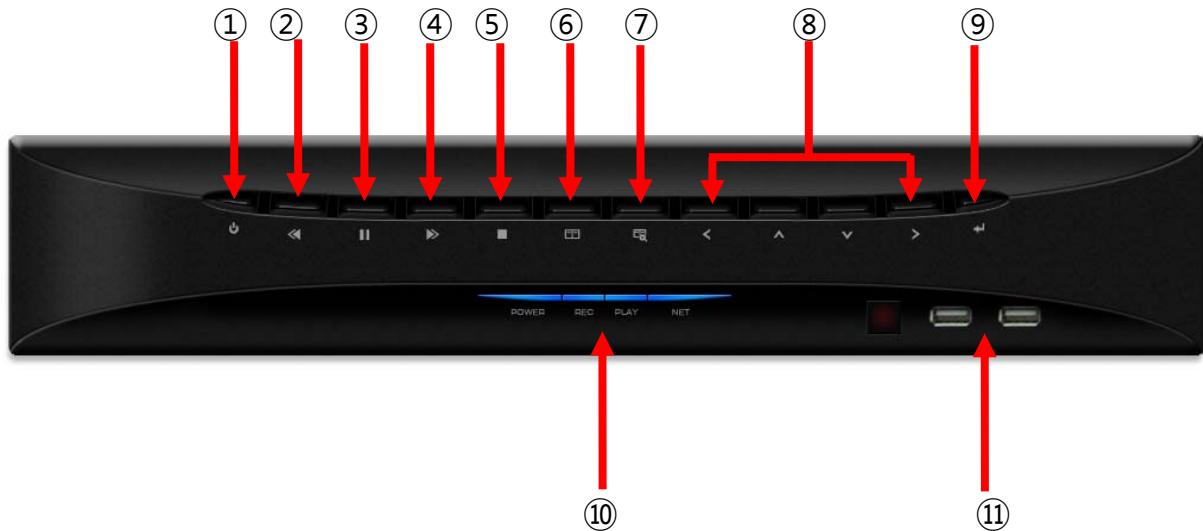

### (1) POWER BUTTON

System Power On/Off

### (2) REWIND (◀◀)

Reverse play of recorded data

When in play mode press again to enter fast rewind mode.

### (3) PAUSE (||)

To freeze picture on playback mode and live mode.

### (4) Forward PLAY (▶▶)

Playback of the recorded data

When in play mode press again to enter fast forward mode.

### (5) STOP (■)

To stop playback and go back to live mode.

### (6) MENU

Displays the menu on the screen

### (7) SEARCH

Entering search mode

### (8) ARROW KEY

Moves the cursor while in menu mode

### **(9) SELECT**

Menu selection

### **(10) LEDs**

- POWER : System Power On/Off (When power is on, the light will be illuminated)
- REC : Recording status (When recording is on, the light will be illuminated)
- PLAY : Playback status (When playing is on, the light will be illuminated)
- NET : Network status (When network is connected, the light will flash)

### **(11) USB 2.0**

USB 2.0 connector for mouse control & downloading to USB pens / drives (plus upgrading firmware)

## Rear Panel Connections

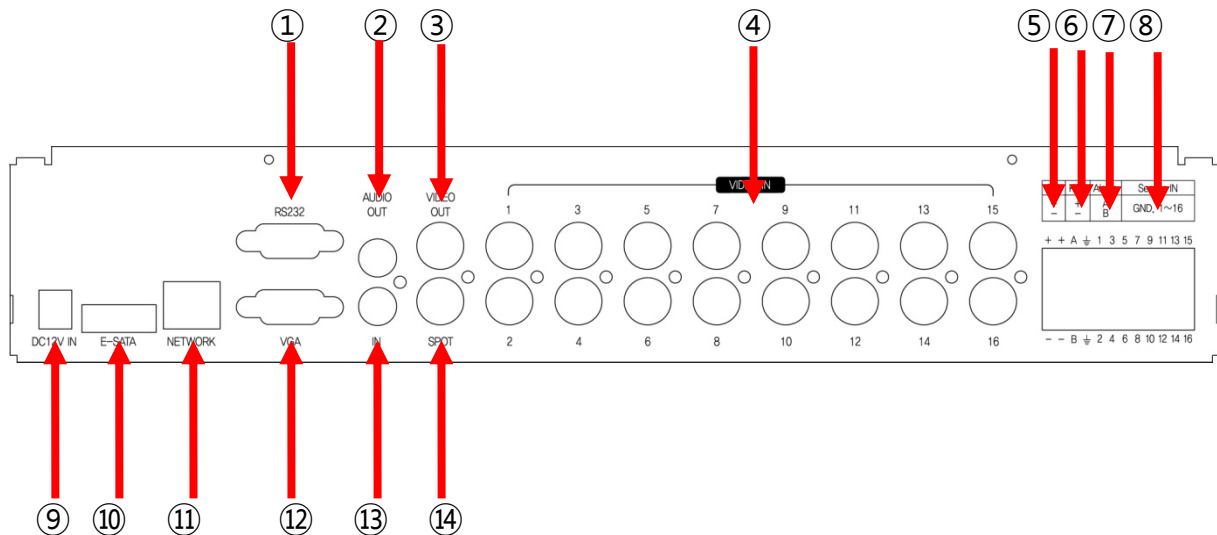

### (1) RS232

Serial Communication

### (2) AUDIO OUTPUT

Audio output

### (3) COMPOSITE VIDEO OUT

Composite Video Output

### (4) VIDEO IN

16 Camera inputs (1.0v p-p, 75Ω)

### (5) PTZ CAMERA CONTROLLER

Serial Communication for Pan / Tilt Camera

### (6) KEYBOARD CONTROLLER

Serial Communication for P/T/Z Control Keyboard

### (7) ALARM OUT

Alarm output port

### (8) SENSOR IN

16 Sensor input ports

### (9) DC IN

DC 12V 3.3A

**(10) E-SATA PORT**

Port for e-sata HDD

**(11) Network Port (RJ-45)**

Connecting to the Quantum DVR through Internet or LAN

**(12) VGA VIDEO OUT**

VGA Video Output

**(13) AUDIO INPUT**

Audio input through line

**(14) SPOT OUT**

Spot Video Output

### System Connection Diagram

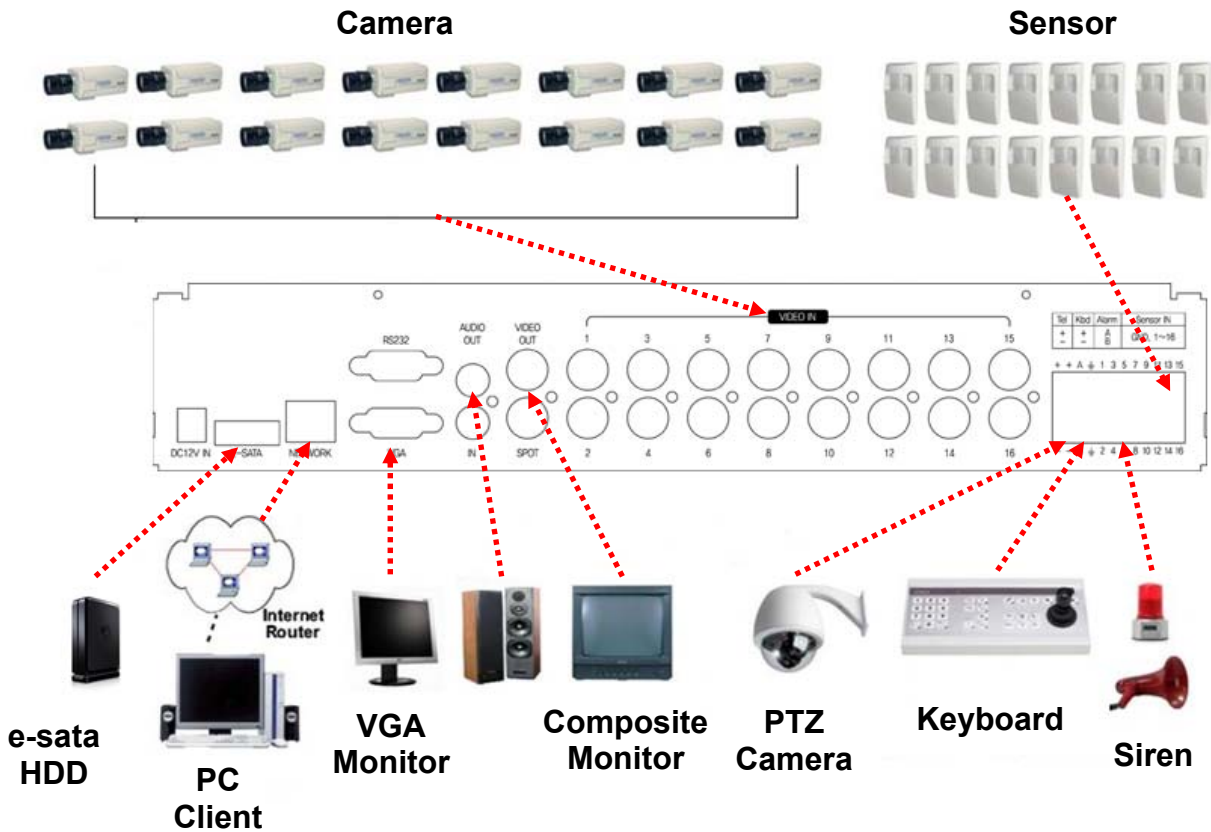

## Alarm Connections

The Alarm connections are made via the push in connectors on the rear on the unit. There are 16 individual alarm inputs marked as Sensor In (1-16) and 2 Outputs marked as Alarm, plus 2 ground connections. As shown below:

Tel	Kbd	Alarm	Sensor IN
+ -	+ -	A B	GND, 1~16

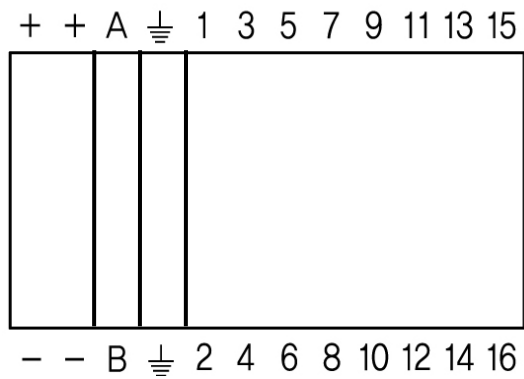

## Remote Control



1. Power: Power ON/OFF
2. REC: Start & Stop Recording
3. (1 to 9) Numbers and letters
4. P/T/Z: Entering PTZ menu directly
5. OSD: On Screen Display ON/OFF
6. SEQ: Sequence operation
7. LOG: Direct access Log list
8. INFO: Direct access system Info.
9. ID: Reserved.
10. MUTE: Audio Mute
11. AUDIO: Switches through Audio channels
12. MENU: Entering system menu
13. SEARCH: Entering search
14. ARROW & SPLIT: Left, Right, Up and Down. Also, Screen split options
15. VOL "+, -" : Up, down volume
16. CH "+, -" : Up, down channel(s)
17. ▶▶ : Play(or fast forward)
18. ◀◀ : Reverse play
19. ||: Pause
20. ■: Stop playback
21. Cam: Changing PTZ icon
22. P/T: Pan & Tilt
23. Z/F: Zoom/ & Focus
24. DIS: Channel Division

## OSD Description

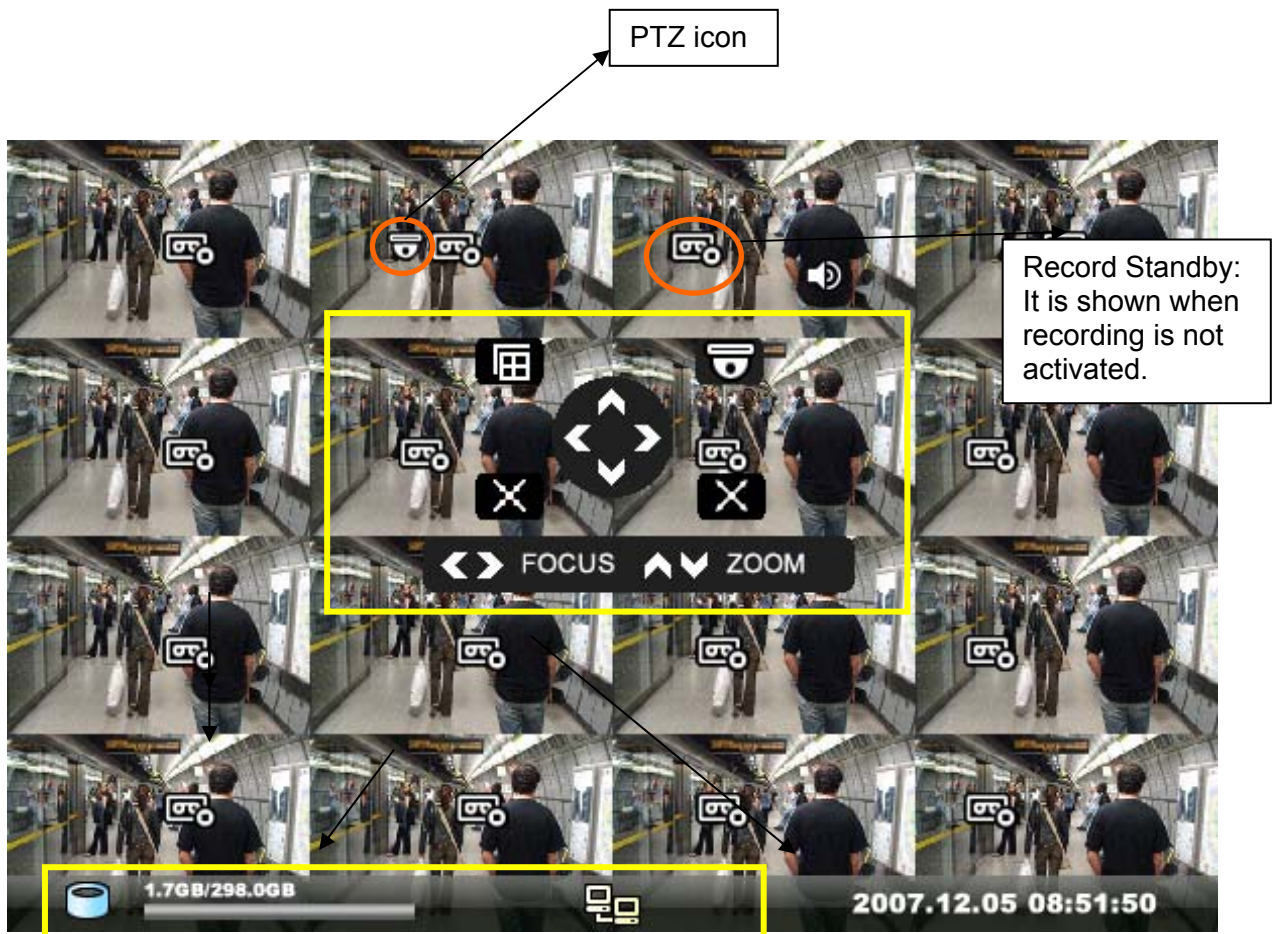

The Status Bar shows HDD capacity, Network connection, Time, etc using by icons.

-HDD capacity  : 1.7GB is used out of 298.0GB

-Network connection  : It is shown that admin or user is connected.

-Date/Time

\*Others :

-Backup 

-Mute 

-USB Stick: 

This screen shows PTZ control of camera 2. The on screen arrows will allow control of this camera.



## Menu Tree

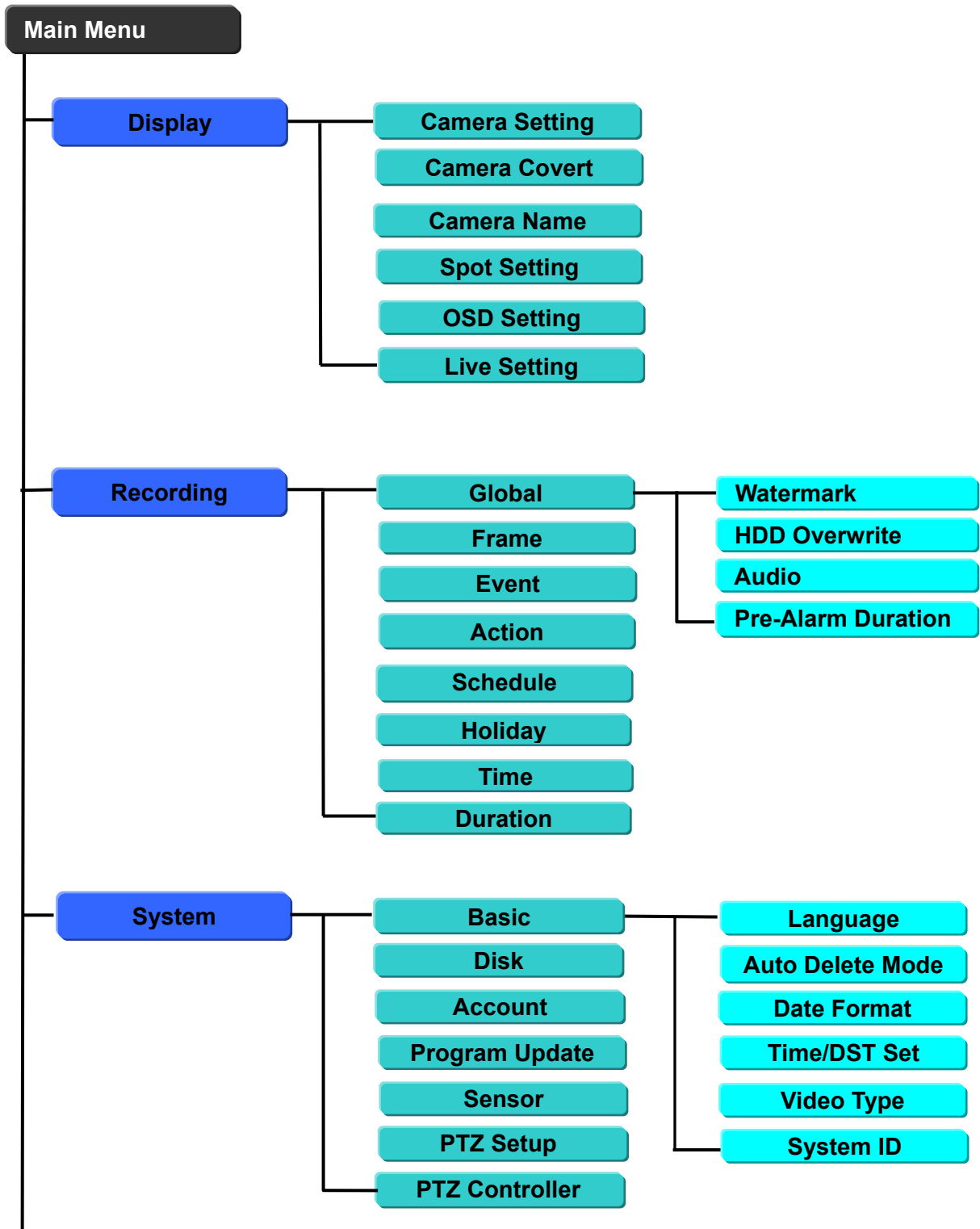

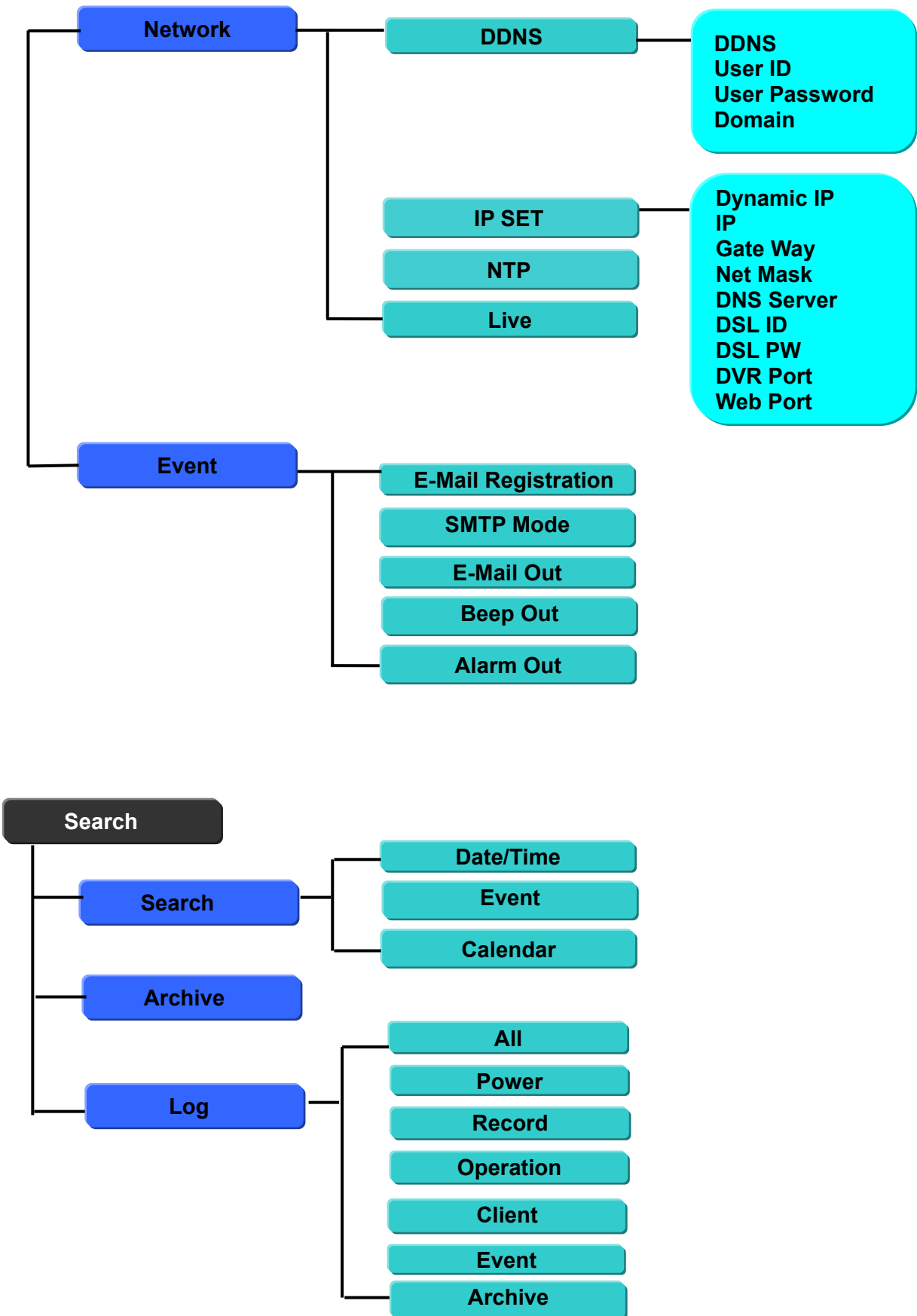

## Default Passwords

### Front Panel

A Password is required if you need to: Log on; enter the menus; down power; stop recording or changing an IP setting.

Logging ON

Before the system can be used it is necessary to Log On as a user, the rights of each user can be managed by an administrator level log on

Press MENU on the front panel, or right click and select the MENU icon. The following box will be displayed asking for password.

The default Password is: **00000000** (8 zeros)



To select a different user press the Select key in the centre of the unit, use the up and down arrows to choose, then press the Select key again to confirm. Then enter this user's password.

### Viewer Software

When using the supplied Viewer software, the default logon details are:

User ID is "**admin**" (not case sensitive).

Password is "**00000000**" i.e. 8x Zero's

(Admin ID cannot be changed, as this is the full administrator ID)



Click on arrow to view a quick connection address book for the last 22 units that the software has been connected to.

This uses the description to quickly identify each unit.

## Menu Navigation

**To enter the set-up menus, the user has to have the required access rights and be logged on** press the Menu button or right click with mouse on screen and select the menu icon. The following screen will be displayed.



### Front Panel or IR remote control

First select the user name by pressing select key and using the up and down key. Next, enter the password (default password is 00000000 – 8 zeros). Use the down key, up key and select key. The following menu page will be displayed.



All menus are navigated around using the left / Right / Up / Down and the Select button. To step back out of the menus press MENU button

### Mouse control

Left clicking the mouse brings up the following display, from this right click on the menu icon to display the password box, use the mouse to select the user name and enter the password.



Note: This display is also used to select Search mode, Turn on the telemetry mode.



If Menu has been selected the following screen will be displayed. Select Sub menus by clicking on the relevant title.

The method of altering the value of a segment within a menu page will vary slightly depending on the page:

1. Clicking on a segment will toggle through available values
2. Click on icon at top of list will change all channel values
3. Click on the box and the following keyboard will be displayed:



Use the keyboard to fill in titles etc, followed by OK to enter the value.

## Remote Keyboard

The remote keyboard is connected via the push in connector on the rear of the unit. The 2 connectors are marked as Kbd (+) and Kbd(-), as shown below:

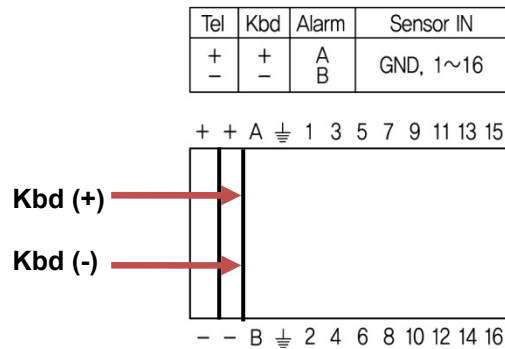

## Menu Settings

### 1. Display

#### [ Camera Setting ]

Brightness, Saturation, Contrast, Hue and default

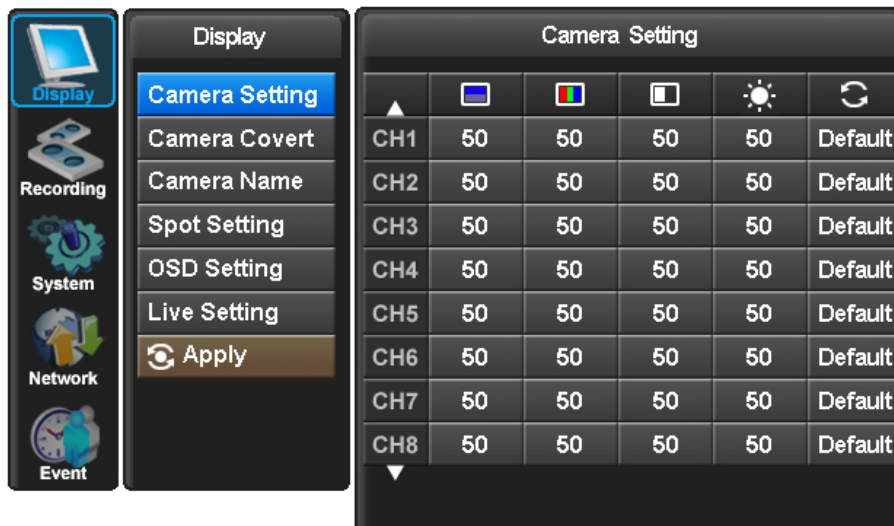

The picture displayed from each camera can be individually adjusted to balance the multi screen view.

Use UP(▲) / DOWN(▼) keys to select the cell to be altered, then press select to turn the box green, then use the numeric keys to change the values.

Alternatively use the mouse to select the cell, the on screen keyboard will appear select the value and click OK

#### [ Camera Covert ]

Cameras can be hidden from the viewer in live or play back mode.

Select the camera to be made covert using the up and down keys, then press select to turn the camera green, toggle between on and off with the up and down buttons.

Alternatively use the mouse to select the camera and click between on and off.

In order to view covert cameras in Live or Playback, it needs to be turned off in the menus, this is requires the necessary user rights.

#### [ Camera Name ]

Each camera can be titled using the alphanumeric buttons on the front panel or the mouse. Each title can have up to 32 characters, if there are too many characters to display in 1 line, it will be shown as \_... For example, 'FIRST MEETING ROOM' -> 'FIRST MEETIN...'

Use the Up and Down arrows to select the title to be altered, press the select key to turn the title green. Use the left and right arrows to select the character position and use the Alpha-numeric keys to select the character ( Similar to SMS on a mobile phone). When complete press the select key to exit.

Alternatively use the mouse to select the title to alter, the on screen keyboard will appear, enter the title followed by the OK button.

## [ Spot Setting ]

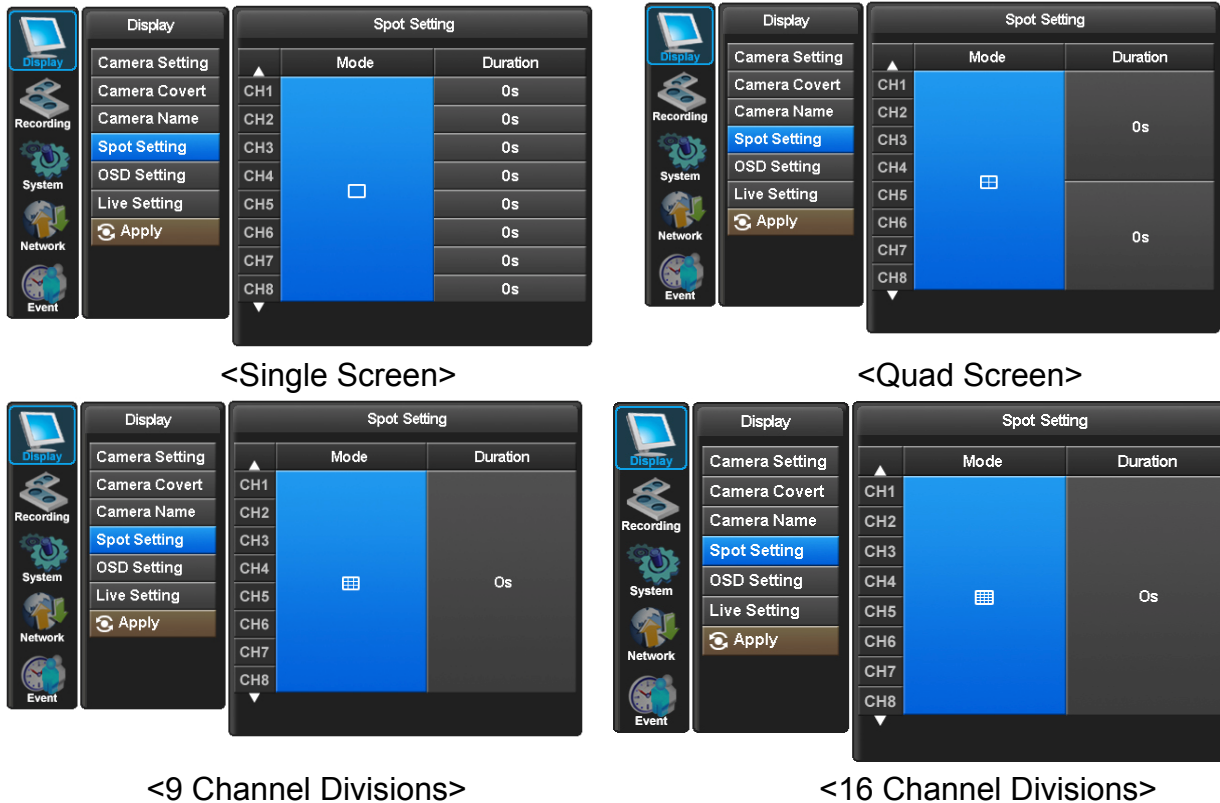

Spot output is used to configure the second monitor output. The Spot monitor can respond to Alarms, Motion, Audio, or can be configured for full or multi-screen sequences.

Use the Select key to turn the Mode box from Blue to Green, use the up and down arrows to select the mode between multi-screen options; Alarms, Motion or Audio.

Once the mode has been selected, you can select either a duration or On/Off option (Mode dependant). Use the Select button to turn the box from blue to green then use the Up and Down keys to alter value. Press select to turn back to blue.

Alternatively, use the mouse to select mode by repeatedly clicking in the Mode box. Then select the duration or On/off for each channel.

## [ OSD Setting ]

Selecting how long the graphic information is displayed on the screen.

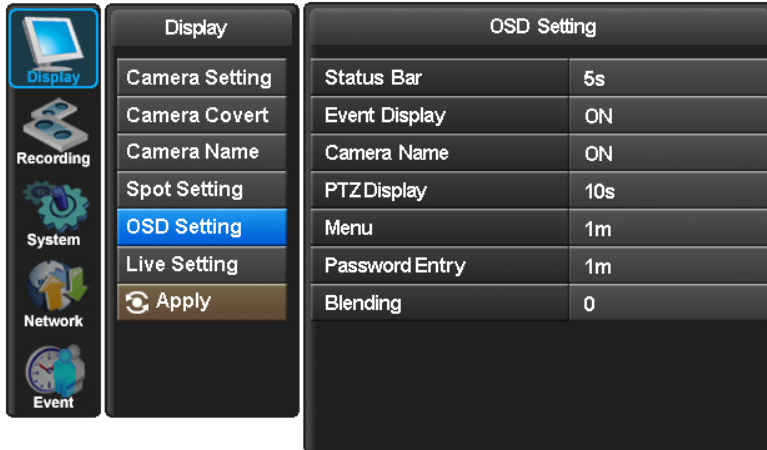

### Status Bar

The display bar at the bottom of the screen can be set to be permanently on or to disappear after a period of time.

### Event Display

Icons such as recording mode, motion detection can be displays or not (On /Off)

### Camera Names

The camera title can be displayed or not (On/Off)

### PTZ display

When in telemetry mode the on screen telemetry display can be set to be Always on or to disappear after a set period of inactivity 5 or 10 second or Off.

### Menu

The menu display can be set to time out after either 1 or 5 minutes.

### Password Entry

The password entry display can be set to time out after 1 or 5 minutes.

### Blending

The opacity of the menus and Status bar can be set between 0 and 6, 0 is solid, 6 being very opaque.



## [ Live Setting ]

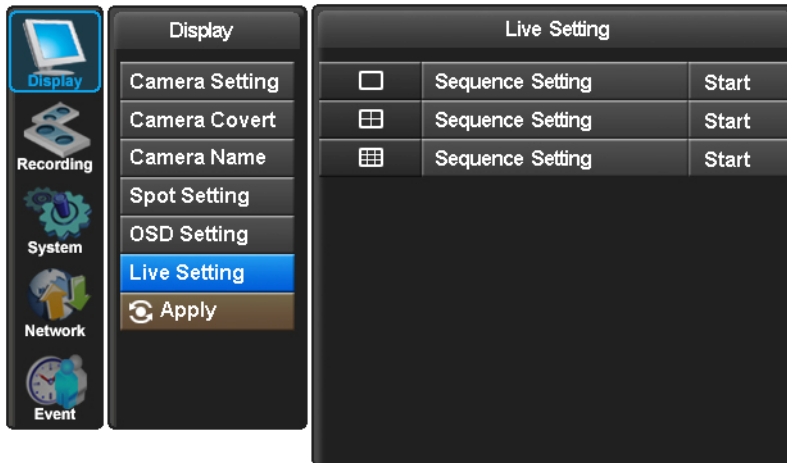

The live settings are used to set up a sequence of either full screen camera images or multi screen displays

Use the Up and Down arrows to select either: Full Screen, Quad or Nine way split sequences. The display will change to allow individual sequence times to be set per channel or split screen option. Use the select key to turn the cell green and then the Up and Down keys to change the values.

Use the right button to move to “Start” press select, the main monitor out put will display this sequence.

Alternatively use the mouse to select the sequence required then select the duration. Click “Start” to turn the sequence on.

To interrupt the sequence, simply select any camera.

**APPLY:** In order to save any modified setting value, press “SEL” key when the “APPLY” section is highlighted. This action can be carried out within each Sub Menu.

## 2. Recording

[ Global ]



### Watermark

Generally this should be set to on, this allows the supplied software to verify the downloaded information to ensure it has not been tampered with or changed.

### HDD Overwrite

Generally this should be set to on to ensure that the DVR does not stop recording when the hard drives are full.

### Audio

Enable each audio channel for global recording.



### Pre-Alarm Duration

This is the time for which the DVR will buffer recordings, to use as pre-alarm events, It can be set to 0, 5, 10, 15 or 20 seconds

## [ Frame ]

This configures the FPS for each schedule – Day/ Night/ Weekend & Holiday/ Time/ Instant recording.

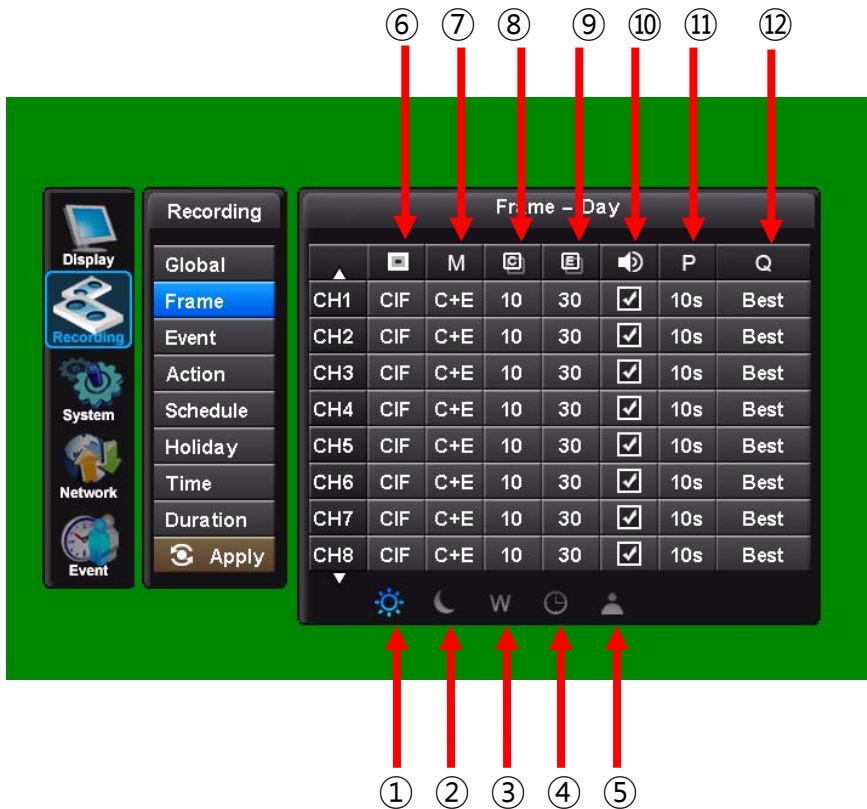

In Schedule Setup, users can define the recording schedule :

- ① Day
- ② Night
- ③ Weekend/Holiday
- ④ Time
- ⑤ Instant Recording

Configure the FPS for each schedule – Day / Night / Week(Holiday) / Time / Instant

### ⑥ Resolution

Each channel can be individually configured for record rate.

In CIF (360x288), 25 fps is available to each channel (total 400fps).

In 2CIF (720x288), 12.5 fps is available to each channel (Total 200fps).

In D1 (720x576), 6.25 fps is available to each channel (Total 100fps).

- ⑦ **Recording mode** : [C] / [E] / [C+E] / [N/A]  
C : Continuous , E : Event , C+E : Continuous + Event
- ⑧ **Continuous Recording FPS**  
NTSC : 0~30fps , PAL : 0~25fps
- ⑨ **Event Recording FPS**  
NTSC : 0~30fps , PAL : 0~25fps
- ⑩ **Audio recording**  
Enable each audio channel for recording.
- ⑪ **Post recording**  
10 ~ 99 sec
- ⑫ **Quality**  
Best / Good / Standard

## [ Event ]

When an event comes in the DVR records the image according to its settings(Frame menu) and triggers an alarm(Action).

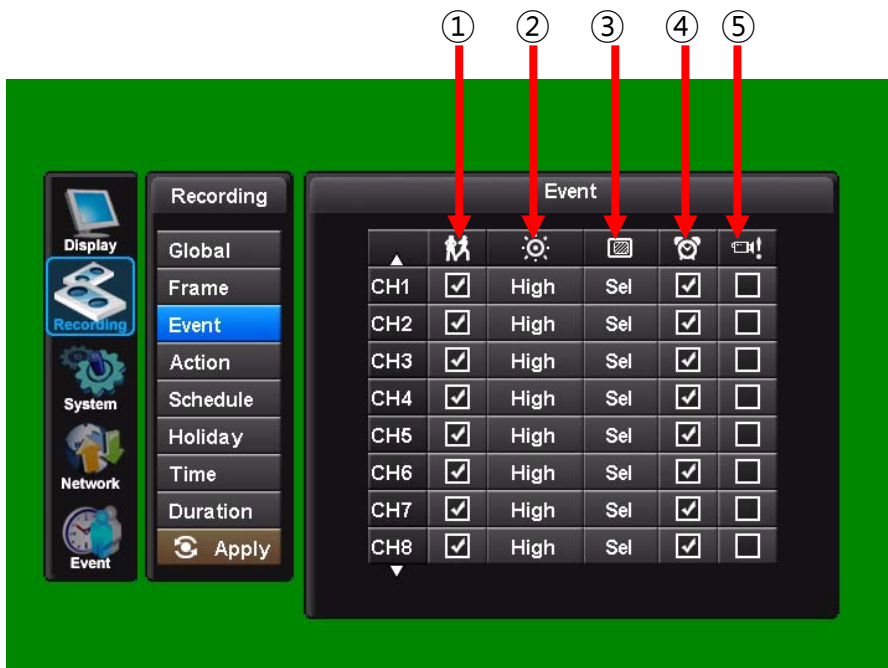

- ① **Motion On/Off**  
Specify whether to use motion input or not.
- ② **Motion Sensitivity**  
Low / Medium / High

### ③ Motion Area

Define the motion detection area.

To setup the motion detection grid per channel select the “Sel” button

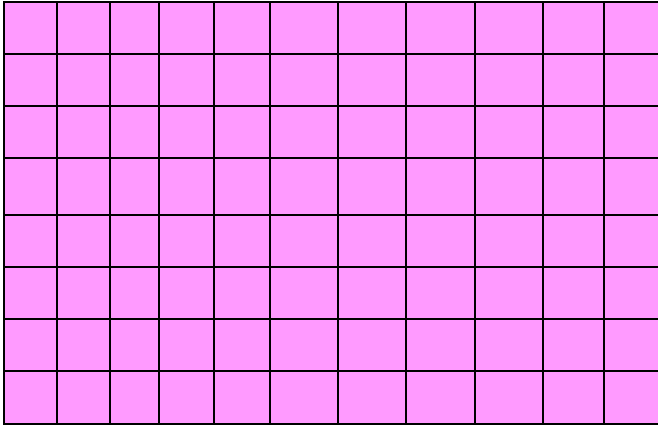

The detection area is divided into a grid of 11x9(PAL) / 11x8(NTSC) cells. Default is all cells in active mode.

Use the Left/ right/ up/ down button to move cursor and the Select key to toggle between active and inactive.

The mouse can also be used to select cells and toggle them on and off.

Care must be taken in setting of the motion sensitivity. It is recommended that each level is tested to find out which one suits that particular camera site.

The motion detection is not recommended for external cameras.

### ④ Alarm (Sensor)

There are 16 Alarm inputs on the rear of the unit.  
Associate each sensor with the camera channels.

### ⑤ Video Loss

Select a channel to report video loss on.

#### [ Action ]

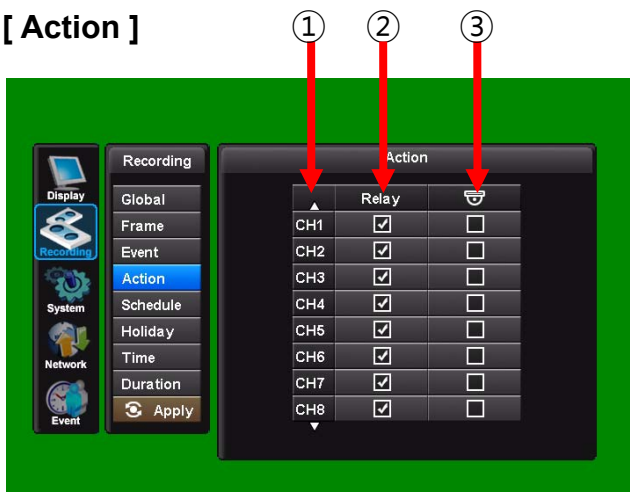

① **Channel**

▲ Channel 1~8    ▼ Channel 9~16

② **Relay On/Off**

Associate an alarm relay with a channel.

③ **Preset on Alarm**

Enable PTZ camera to move to a preset position when an event occurs.

See PTZ control for more information.

A single alarm input can be used to drive up to 4 PTZ cameras to preset positions or Preset tours.



[ **Schedule** ]

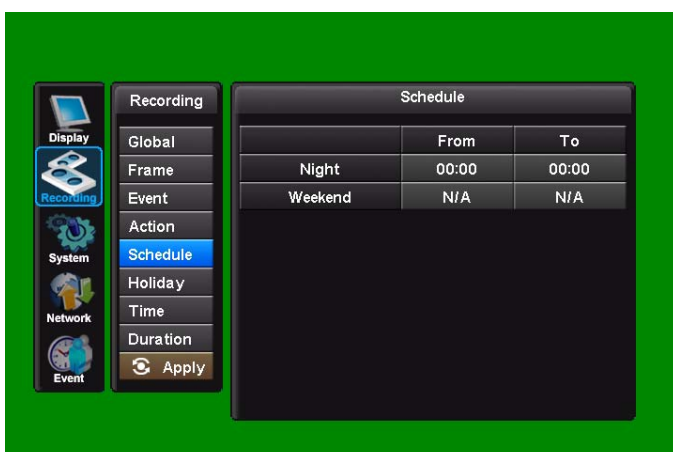

① **Night**

Set night time.

Ex. If 18:00 to 6:00 is defined as night time, 6:00 to 18:00 is defined as daytime.

## ② Weekend

Define weekend.

## [ Holiday ]

Define Holiday

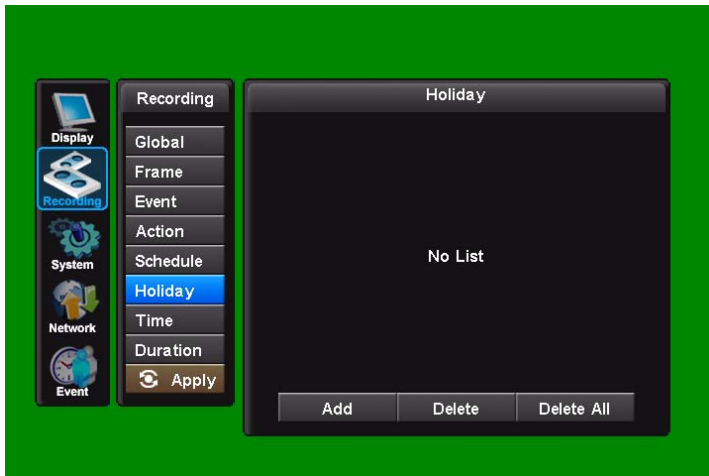

(1) Press ADD button.

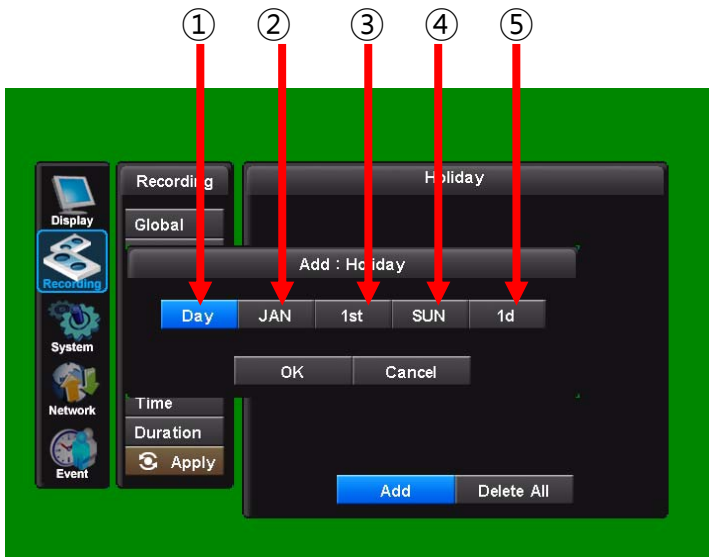

(2) Define holiday pressing the buttons.

- ① Select day or date
- ② Month
- ③ Ordinal
- ④ Day
- ⑤ Duration

(3) Press OK button when finished setting the holiday.

## [ Time ]

The time recording allows the DVR to be set to only record at particular times of the day.

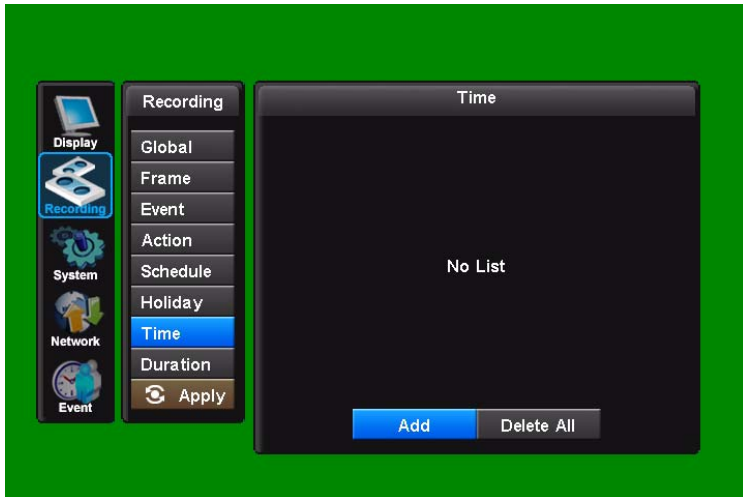

(1) Press ADD button.

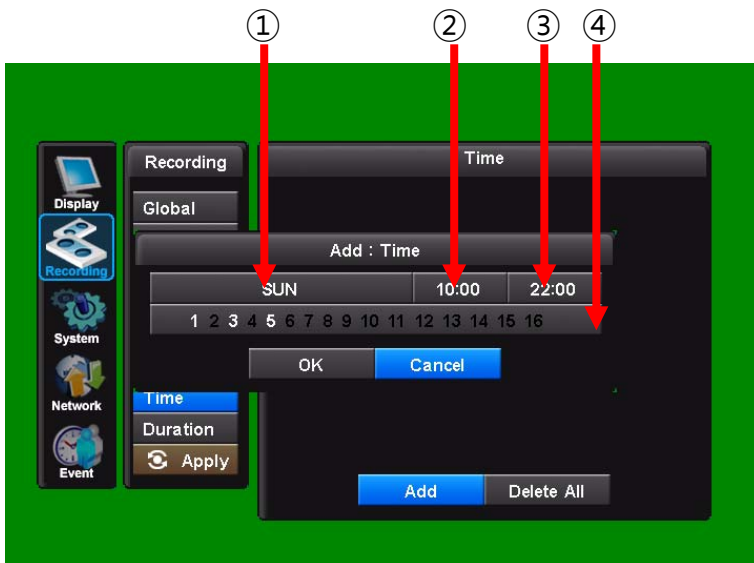

(2) Set the recording time pressing the buttons.

① Day ② Start Time ③ End Time ④ Channel

(3) Press OK button when finished setting the recording time.

(4) Repeat the above steps to set up more recording times.

(5) Press APPLY to save settings.

## [ Duration ]

The Duration mode allows the user to set the number of days that they require to record for.



The resolution; whether cameras are active or not and whether audio is being recorded can each be set per channel. The user then sets the number of days of recording required, then the E4000 will automatically calculate best record rate to achieve these settings

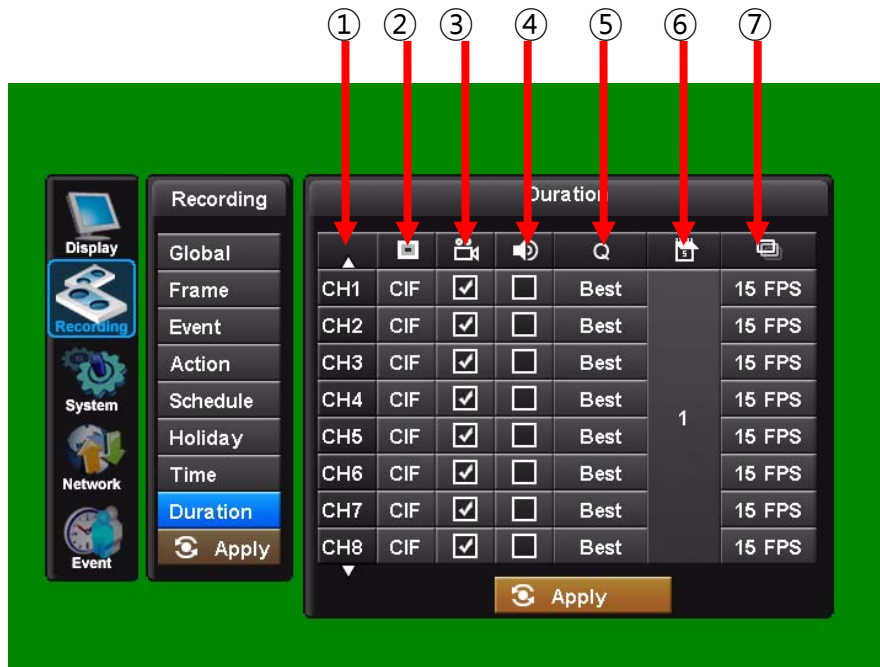

### ① Channel

▲ Channel 1~8 ▼ Channel 9~16

### ② Resolution

Each channel can be individually configured for record rate. (CIF/2CIF/D1)

### ③ Recording On/Off

Specify whether to record a video or not for each camera.

### ④ Audio recording On/Off

Specify whether to record an audio or not for each camera.

### ⑤ Quality

Specify the record quality for each camera. (Good/Standard/Best)

### ⑥ Duration

Specify how many days DVR will record on the HDD.

### ⑦ Recording FPS

It is changed automatically by the duration value.

### **NOTE:**

If the duration recording is in set, all the frame menu settings will be returned to the factory default.

## 3. System

### [ Basic ]

User can set Language, Auto Delete Mode, Date Format, Time/DST Set, Video Type, System ID. Also, Initialisation and system Information is available.

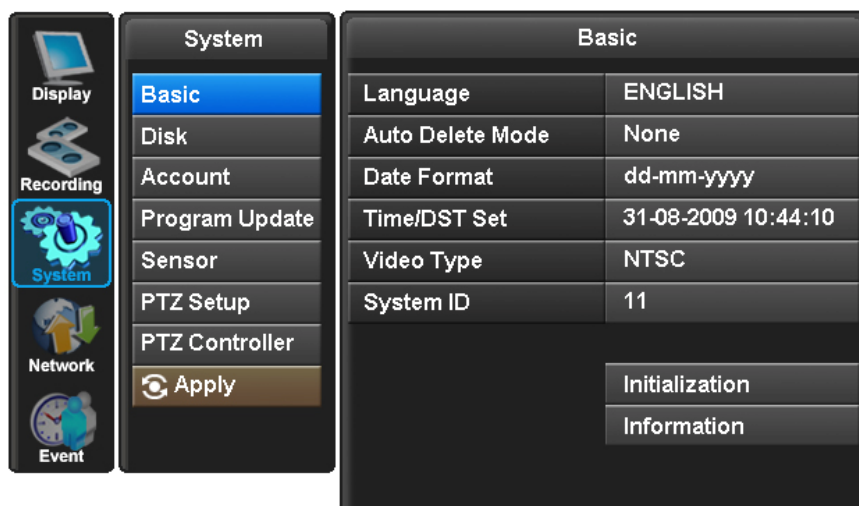

### Language

The default is English. Italian, French, Hungarian, Slovak, German, Russian, Chinese, Dutch, Spanish, Portuguese, Japanese Danish and Polish are available.

### Auto Delete Mode

Auto Delete Mode can be set to automatically erase recorded older than a certain number of days. This can be set between 0 and 99 days.

### Date Format

The default is dd-mm-yyyy. Other date formats available are: mm-dd-yyyy // yyyy-mm-dd.

## Time/DST Setting

The DVRs time can be set by clicking on the time and date displayed in this section, the on screen keyboard will appear. Set the time and date and click Ok, next select the country to enable the Day Light Saving mode.

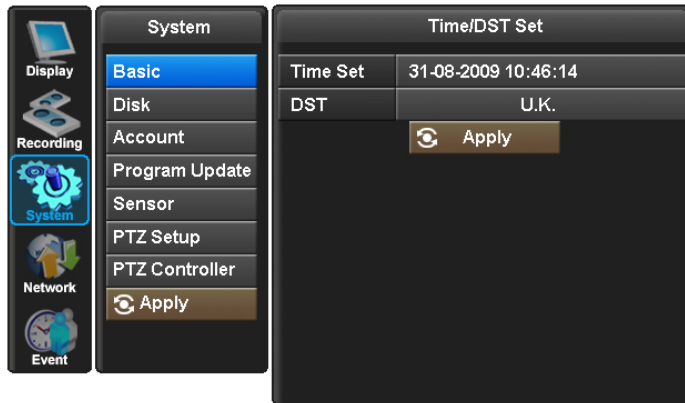

If the country does not appear in the list the use the User define option as shown below:

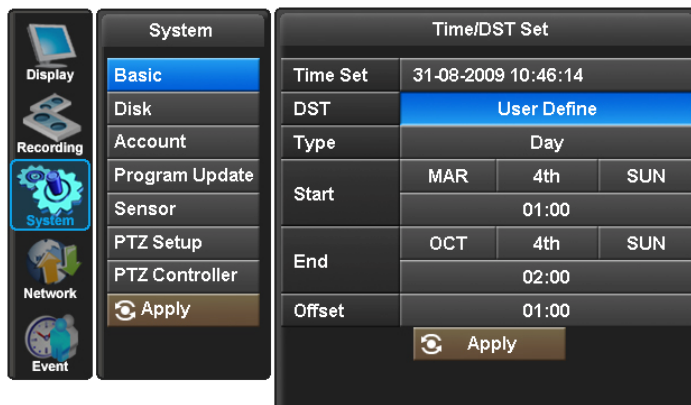

## PLAYBACK FOLLOWING TIME CHANGE

The DVR uses the time and date to index video on the hard disk drive so you can find it later. Changing the time can cause the DVR to work improperly, when you try to play back video. If you set the hour ahead, this is not a problem. But, if you set the hour back, there will be more than one recording with the same time stamp.

Such as during the October Daylight Saving Time changeover, if you try to search for video between 1 am and 2 am, the recorder may not operate properly because there will be two hours of recorded video during this time period. To view video during this overlapping time period, you must start playback before 1 am, then recorder will play both hours between 1 am and 2 a.m.

You cannot do a backward search through the overlapping time. But, you can do forward search.

The Time and Date and the DST time can be changed from the front panel, the Mouse or the Remote Control

## Video Type

Video Type can set in this menu without rebooting or initialisation. The default is PAL, NTSC can also be selected

## System ID

The remote control can be used to control up to 16 DVRs, the ID number on each can be set to a unique address so that the remote will only control one at a time if they are in close proximity. The default is 11.

Repeated click on the ID value to change to the required number.

To select a unit on the remote control press the ID button, followed by the number, followed by the ID button again. The LED will flash slowly.



## Initialization

All the menu settings will be returned to the factory default. To carry out this function the system recording will have to be turned off.

## Information

The Information Screen shows the hard disk size, current firmware revisions, IP address and MAC address

System		Information	
Display Recording System Network Event	Basic	HDD Capacity	230.4GB / 232.8GB
	Disk	UBOOT Version	2009 0617 1844
	Account	OS Version	2009 1619 0719
	Program Update	Client Version	2009 0824 0101
	Sensor	Player Version	2009 0824 0101
	PTZ Setup	Application	2009 0826 0050
	PTZ Controller	Data Version	2009 0824 0545
	Apply	IP Address	192.168.010.013
		Mac Address	00:1C:46:00:36:D6

## [ Disk ]

### Format

Formatting of the drive is used when new drives are installed or you need to wipe all information on the disk.

Click on OFF to turn to ON, then click on Execute, click YES, to confirm

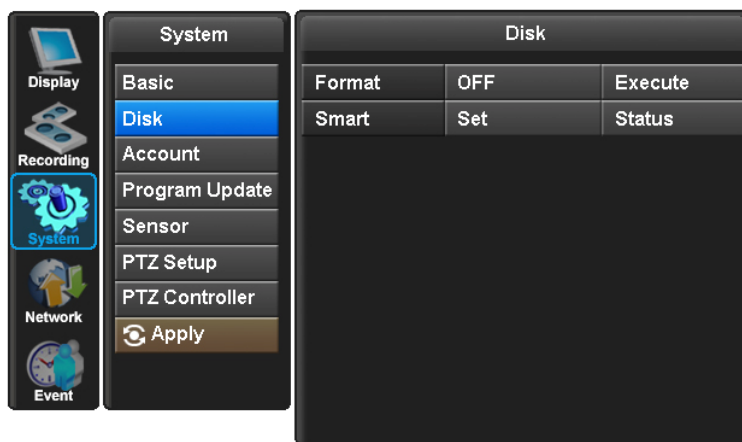

### Smart

This function is used to keep a check on the health of the Hard disk. The parameters which can be monitored are:

1. Read/Write errors on the drive
2. Drive temperature.

To set enable these features, click on "Set", three options will be presented:

Smart – Turn to on to enable feature

Temperature – Using the on screen keyboard set the temperature at which the warning is to be reported. (recommended setting 45)

Message Box - The message box can be turned on or off to give a visible warning. Alternatively and E-mail; can be sent if any problems occur. (see the Event menu set-up section)

## [ Account ]

The DVR can have the following different levels of operators, each with different users rights and passwords:

- Admin level – Operators logged in at this level has full rights
- Manager level – Operators logged in that this level as default have access to all except: Stopping Recording and Shutting down the DVR.
- Users 1-4 - Operators logged in at this level Only have the ability to Search and play, Control PTZ cameras and get access via the network.

Each users rights, can be individually tailored to their own requirements, the amending of these rights can only be done by an Administrator level log on.

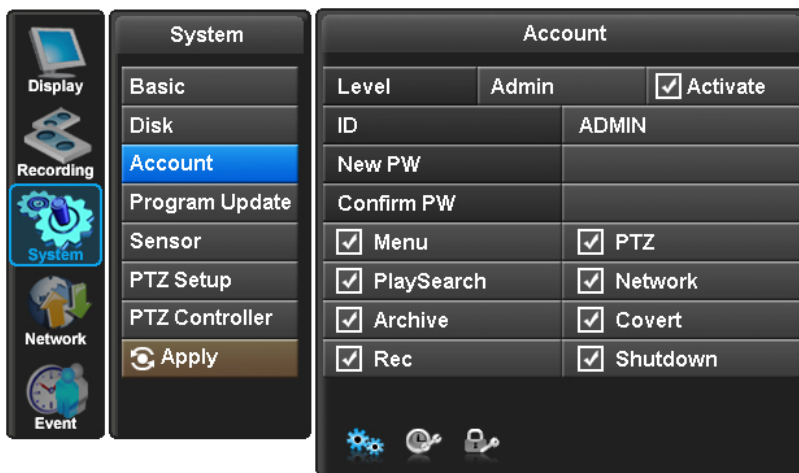

## Amending operators settings and user rights

Click on the box beside Level, this will step through the 6 Operator set up pages, chose the operator required.

The operator ID can be changed using the on screen keyboard

The operators Password can be changed

The operators user rights can be amended:

Menu – Allows access to the menu

Play/Search – Allows access to the Playing back and Searching

Archive – Allows the ability to download information

Rec - Allows the ability to turn off recording

PTZ – Allows the ability to control PTZ cameras

Network – Allows the ability to view remotely with the client software

Covert – Allows the ability to view covert cameras

Shutdown – Allows the ability to turn the power off from the front panel

Once the above has been set, ensure that the Activate box has been ticked.

## Automatic timed log out

The system can be set to automatically log out a user after a certain amount of time if no key presses have been made. The operator level has to have been activated before this can be set. While in the account setup page for the User, click on the middle icon at the bottom of the menu page , the screen will change to show the following:

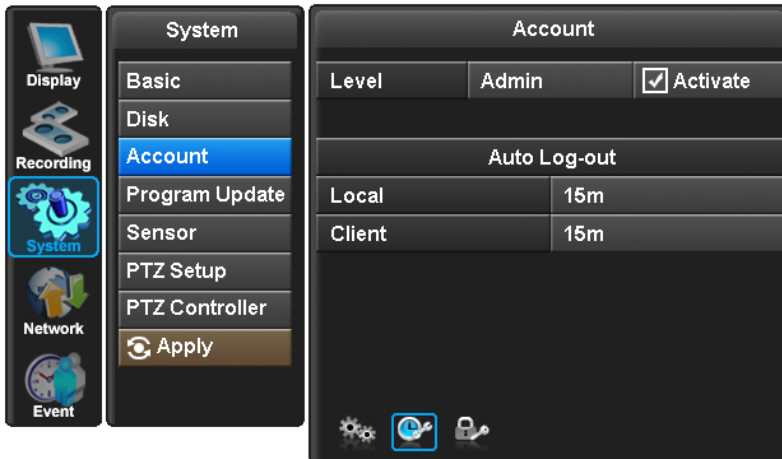

Click on the boxes adjacent to “Local” for the time out period for operation form the front panel. Click on the box adjacent to “Client” for the time out period for operation form the client software. This can be set to either: Off, 15 mins, 30 mins or 1 Hour.

## Archive log access

Access to the archive log is password protected, use this section to amend the password per user. This will allow traceability of which user has downloaded information.

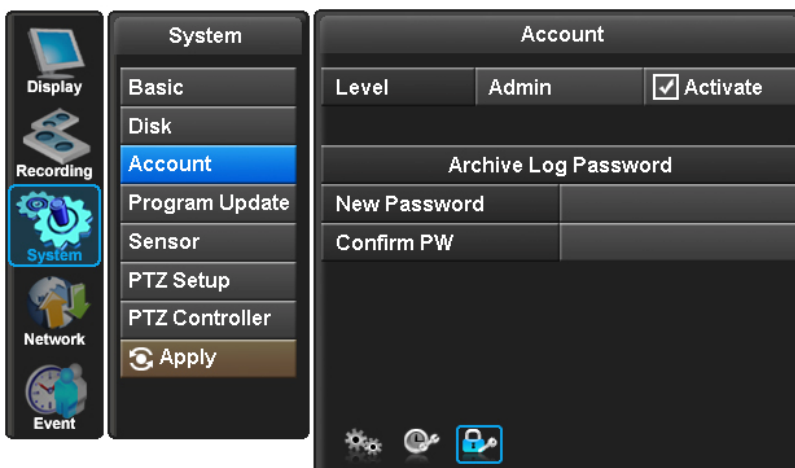

### [ Program Update ]

**Always turn off : Playback and Network access while upgrading the unit**

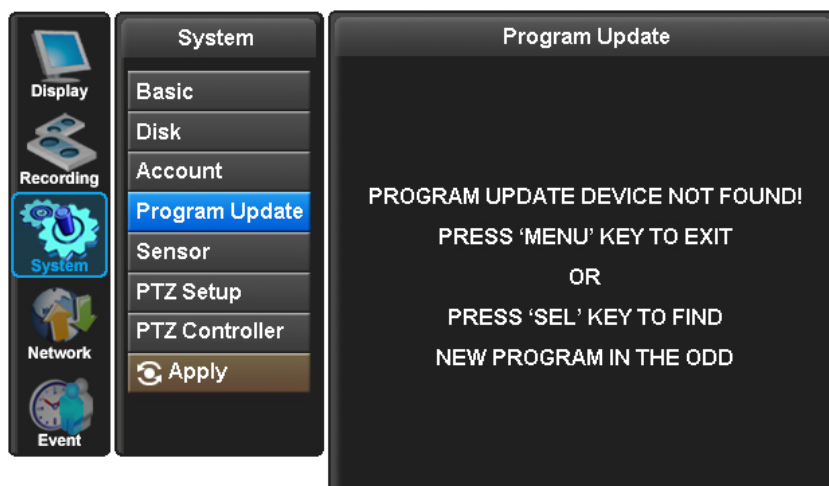

The latest firmware version can be upgraded through USB 2.0 Port using Memory Stick or CD/DVD Media. When a memory stick is connected to the USB port, this symbol  will be shown in the status bar of the screen.

Enter "menu"-> "System Set"-> "Program Update". If the system recognizes the new firmware then, "New program found" will be displayed on the screen. Next press the "SELECT" button.

Processing percentage will be displayed.

#### NOTE

1. If the system doesn't recognize the new firmware, "New program not found" will be displayed.
2. USB compatibility has been tested successfully with: Lexar Jumpdrive 128/256MB, Sandisk Mini Cruzer & Cruzer Micro 2GB, KINGSTONE 2GB, A-DATA 2GB, IMATION 2GB, SANDISK 1GB, SANDISK 512MB, MARUZEN 1GB
3. For system stability, please turn off 1) recording 2) playback 3) network connection during upgrading.
4. After updating program, reboot the DVR. The simplest way is press POWER button and enter the password.



## [ Sensor ]

The 16 alarm inputs on the rear of the Quantum can be configured to be normally open (N.O), normally closed (N.C) or None.

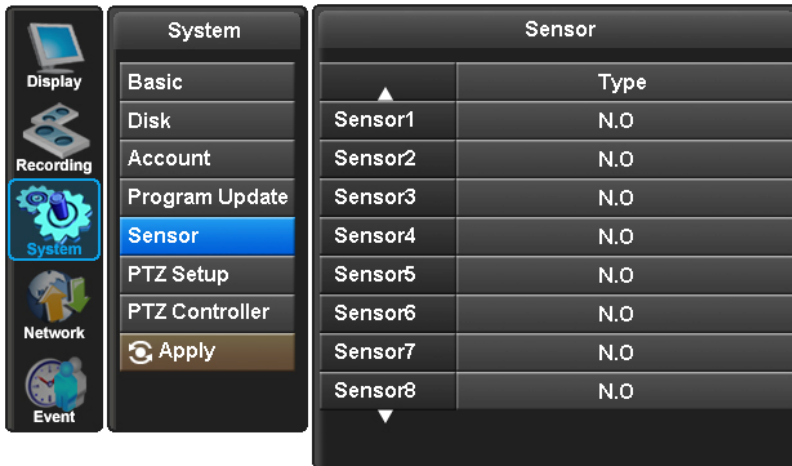

## [ PTZ Setup ]

The E4000 DVR can control PTZ cameras via coax or a RS485 connection on the rear of the DVR. The cameras can have individually selectable Protocols with a choice of Pelco P or Pelco D etc. The Baud rate can also be selected.

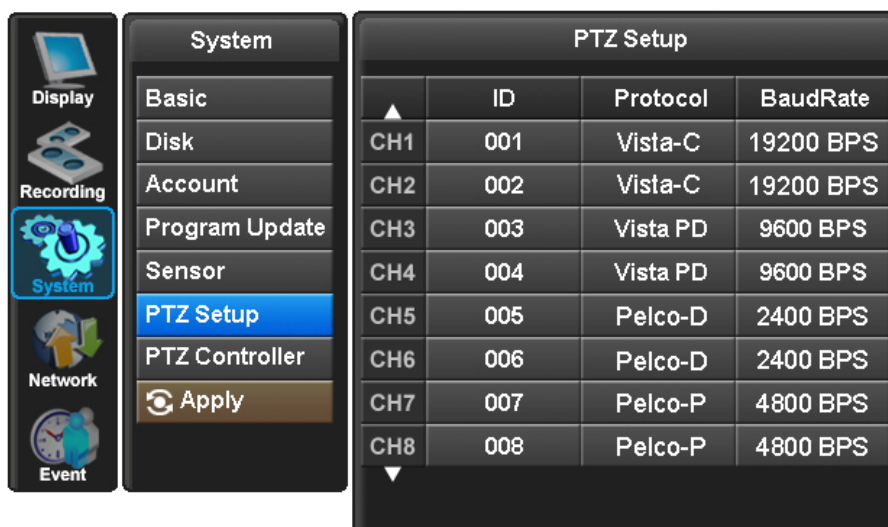

## [ PTZ Controller ]

The E4000 DVR needs to be setup to accept the VKBD3im, VKBD4 or QSC1000 keyboard, as a default this will be set to the correct Protocol and Baud rate, the ID RS485 Address may need to be adjusted dependant on the number of PTZ cameras on the system. The Keyboard ID should not be the same as any of the domes on the system.

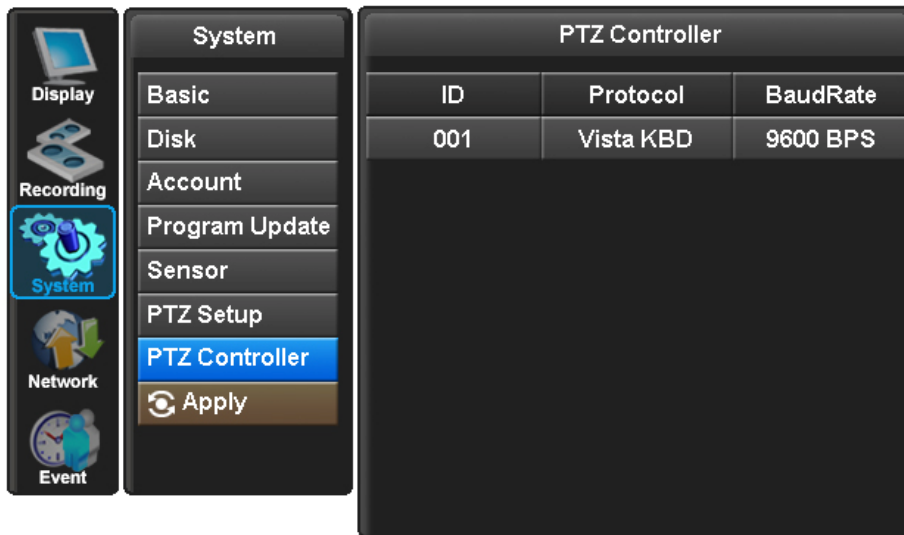

## Telemetry connections and User Instructions

### Remote Keyboard Connections

The connection of the keyboard to the E4000 DVR, is made via the push connectors marked as **Kbd** on the rear of the DVR, These is the 2<sup>nd</sup> connector to the left hand side of the bank of push in connectors.

Tel	Kbd	Alarm	Sensor IN
+	+	A	GND, 1~16
-	-	B	

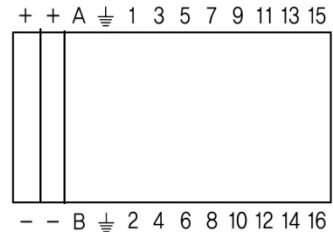

### RS485 Dome Telemetry connections

The connection to RS485 domes is made via the push connectors marked as **Tel** on the rear of the DVR.

Tel	Kbd	Alarm	Sensor IN
+	+	A	GND, 1~16
-	-	B	

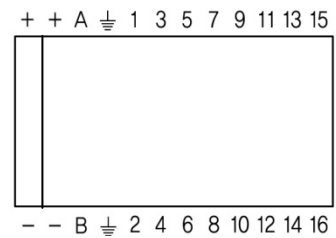

The domes can be wired in a Daisy chain, examples shown below.

#### Daisy Chain configuration

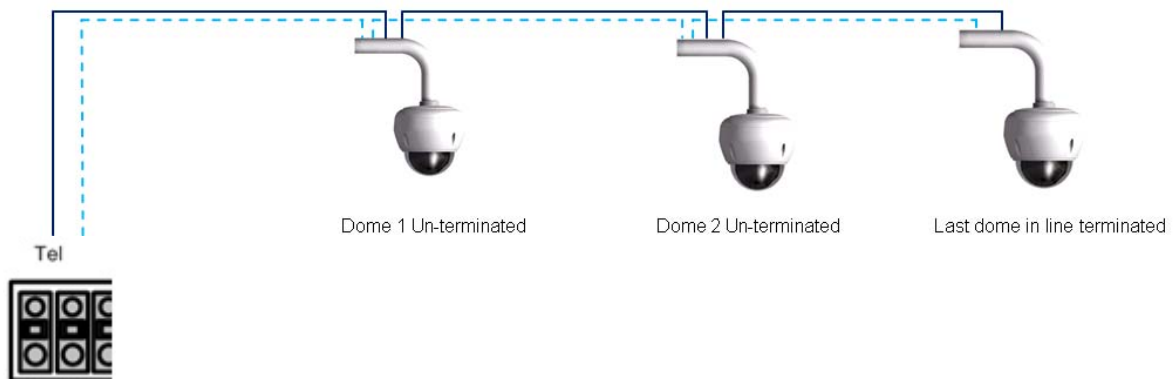

## PTZ user instructions

The telemetry function of the Quantum Plus can be controlled via 3 different methods:

1. Remote keyboard
2. Remote control
3. Software viewer

**Remote Keyboard :** See keyboard manual for control of PTZ cameras

## Remote control functions

### [ Camera selection ]

The PTZ cameras can be controlled in either full screen or split screen mode. If in full screen mode press the camera selection key  , the camera icon will step from one camera to the next on the split screen. When the icon appears on the camera to be

controlled then press the PTZ key  .

If in full screen mode then simply press the PTZ key  .

### [ Pan and Tilt control ]

To move the dome left / right / up or down use the arrows keys .

### [ Zoom and Focus control ]

To select Zoom and Focus press the Zoom Key .

Zoom + =     Zoom - =     Focus Near =     Focus Far = 

### [ Preset positions ]

1. To store a preset position

Move the camera to the required position then press the record key  followed by the number key of the preset to be stored (1 – 9)

2. To recall a Preset

Press the search key  followed by the number (1 -9).

## [ Run Tour 1 ]

To run Tour 1, press the search key  followed by the number 0 (Zero). The tour requires a keyboard to set it up in the domes menu.

## Dome Menu access

When controlling PTZ domes from the E4000 DVR, it is possible to enter the Dome's menu structure, using the Remote Keyboard, Mouse or the Client software. The method from each device is slightly different; the following section will explain each method.

### Remote Keyboard



1. Select Dome from the Keyboard, ensure the keyboard is in Pan and Tilt Mode.
2. Use the Joystick to move the camera.  
\* For more detail, please refer to your keyboard manual.

### Mouse

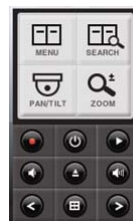
1. Right click mouse
2. Mouse menu screen will appear:
3. Left click MENU
4. The password box will appear
5. ENTER 1, 2, 3,4

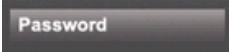

## E4000 installation and user manual

6. Click On the word 
7. The Dome Password Menu will appear
8. Using the Arrows enter the Domes password, 
9. Once in the Menus use the arrows to navigate.
10. To Exit repeatedly press ESC
11. To remove the navigation arrows, right click.

### Client Software

1. While Client software is running select the dome required.
2. Enter Pan and tilt mode by clicking on the  icon

3. The Pan and tilt control window will appear
4. Click on the central button 

5. The following box will appear
- 6.

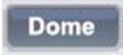

7. Select the Dome Button 
8. The dome password menu will appear

9. The pan and tilt control window will change to the following 
10. Use the arrows, SEL ( ENTER) and PREV(ESCAPE), to navigate around the menus
11. To Exit the menu mode repeatedly press PREV.

12. To return to PTZ mode press the  button.

## 4. Network



(If the DVR is connected to a network, this icon will be shown in the OSD display)

This menu can only be accessed if the user has the necessary rights. (Default password is 00000000).



With in the Network menu the DDNS (Dynamic Domain Named Server), IP addresses, NTP and Live can be set.

### [ DDNS ]

What is DDNS?

DDNS is a service that maps Internet domain names to IP addresses. DDNS serves a similar purpose to DNS: DDNS allows anyone hosting a Web or FTP server to advertise a public name to prospective users.

Unlike DNS that only works with static IP addresses, DDNS works with dynamic IP addresses, such as those assigned by an ISP or other DHCP server.

What this means is that the DVR does not need a Static IP address to be available for viewing remotely over the World Wide Web.

Please refer to Appendixes 4 on how to set up the DDNS service.

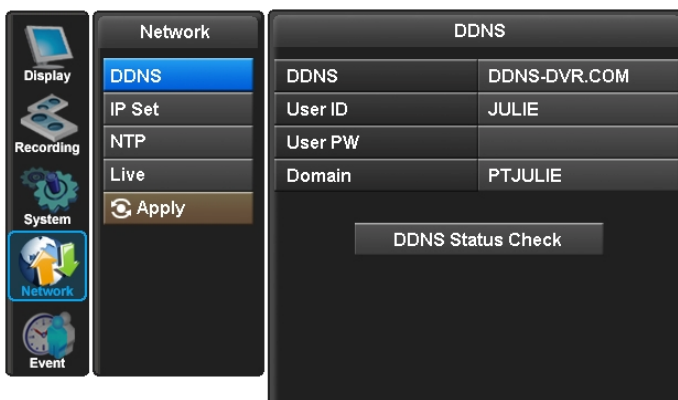

## [ IP SET ]

When a fixed IP address is being used, the Use Dynamic IP should be set to NO  
The IP Address, Gateway and Subnet Mask need to be set, these will generally be given by the Network Manager.

DSL refers to all types of Digital Subscriber Line such as ADSL and SDSL.

The DVR Port and WEB Port can both be changed if required, default are 2000, and 80 respectively.

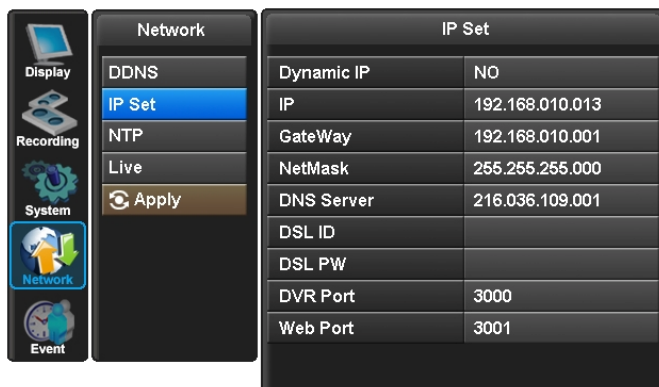

## [ NTP ]

The Network Time Protocol Setting allows the DVR time to be synchronised with an external time server.



The default is NTP OFF. When turned on the Type of service can be selected, options are Default (time.bora.net), Domain and IP. As shown in next diagram:



## E4000 installation and user manual

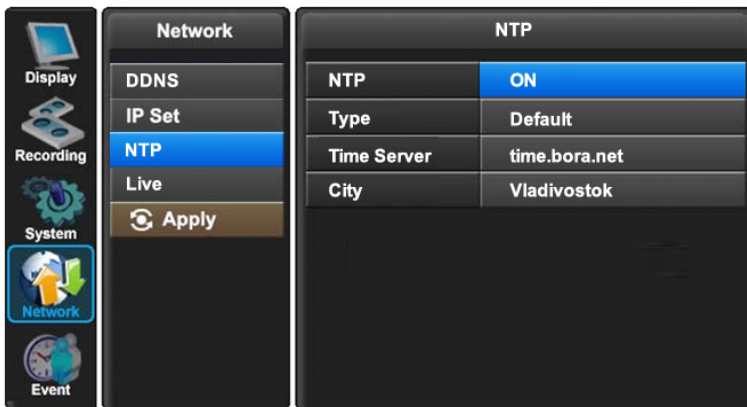

The Time zone can also be chosen within the City selection, use the right arrow on the front panel to change the city settings.

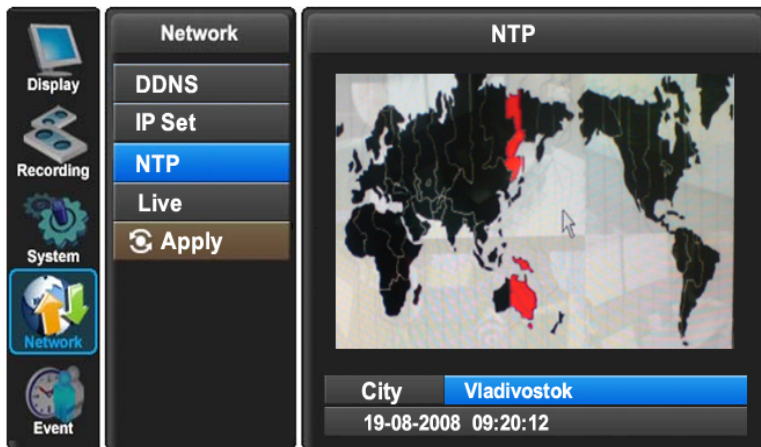

### [ LIVE ]

This allows a separate Live viewing resolution and Quality, regardless of System Recording and Quality, to be set for remote viewing, this helps optimise the network streaming.

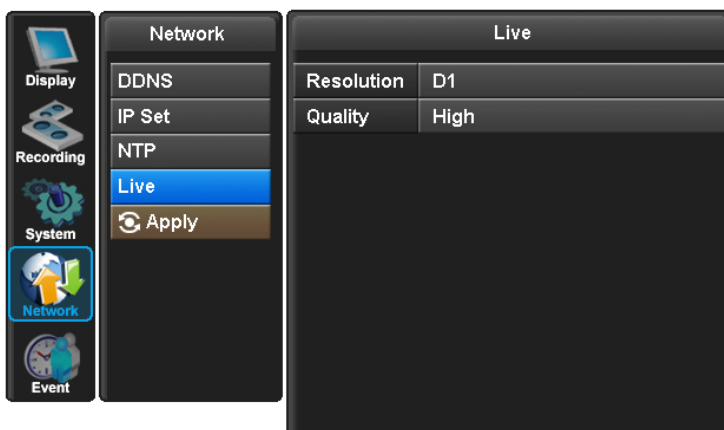

## 5. Event

This section is used to inform the user as to an event occurring, this can be by the sounding of a buzzer or by sending an E-mail to a predefined address.



### [ E-Mail Registration ]

Within this section up to 3 users can be set-up to receive an email on the occurrence of an event such as Video Loss / Alarm / Motion or Power Loss. An E-mail will only be sent if the E4000 is sitting on a network with access to the Internet, e.g. through a router.

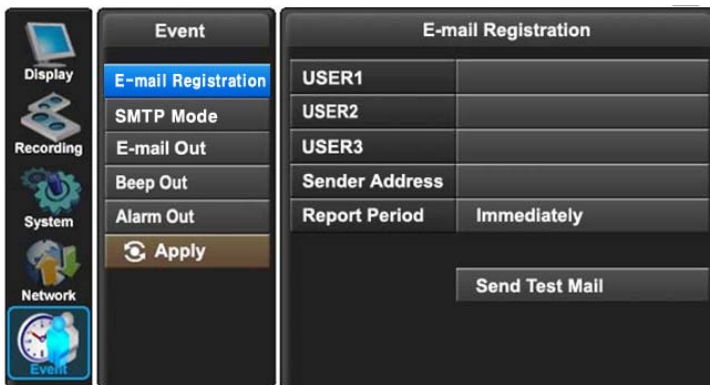

The e-mail addresses are set via the alphanumeric buttons on the front panel, or from the on screen keyboard via the mouse.

The Sender Address is the address that will appear on the E-mail received by the user, this should be set logically to identify the specific DVR.

The report period is used to set how often e-mails are sent: Immediately on and event, Daily or Weekly

SEND TEST MAIL sends a test E-mail to the addresses so allowing the installer to verify if the setup is correct.

## [ SMTP Mode ]

The SMTP (Simple Mail Transfer Protocol) function allows e-mails to be sent over a LAN. The default is SMTP Mode "OFF".



In order to activate SMTP Mode, choose SMTP Mode either IP or Domain first. Then, put ID, Password, IP address, and port. Finally press "SMTP Status Check" to test. Please see the screen shots that follow:

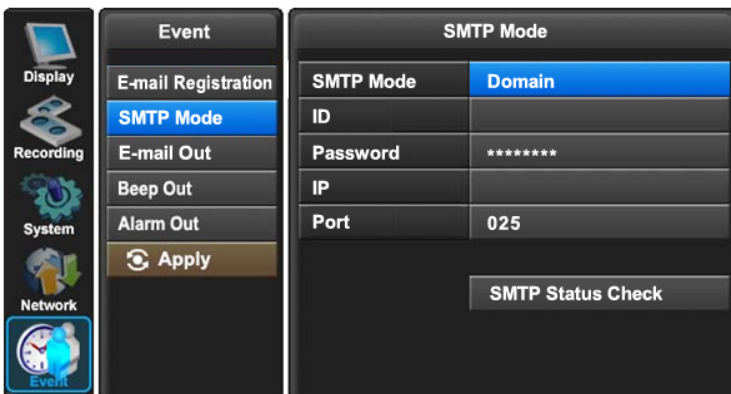
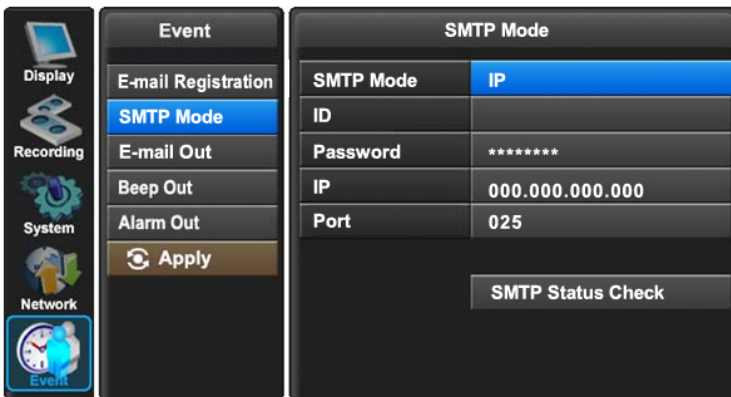

## [ E-mail Out ]

As well as e-mail on event activations the E4000 can be set to send a report on the following occurrences: Video Loss; Alarm; Motion; Power Loss and Smart (Hard disk monitoring).

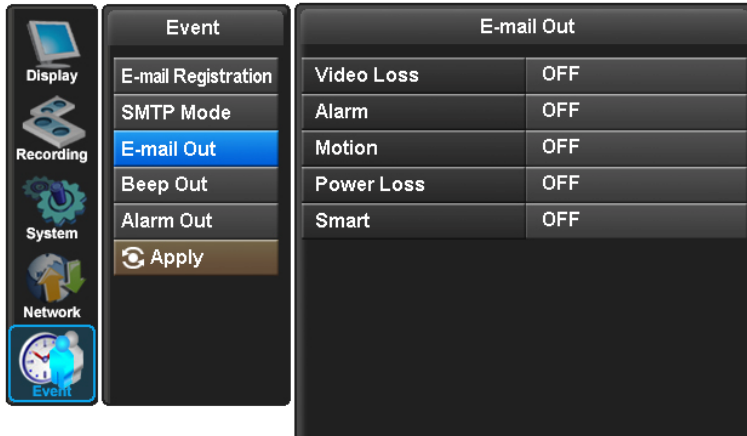

## [ Beep Out ]

The buzzer can be set to sound on the following occurrences: Video Loss; Alarm input; Motion detection; Power Loss; Smart (Hard disk monitoring).

The duration of the beep can be set.

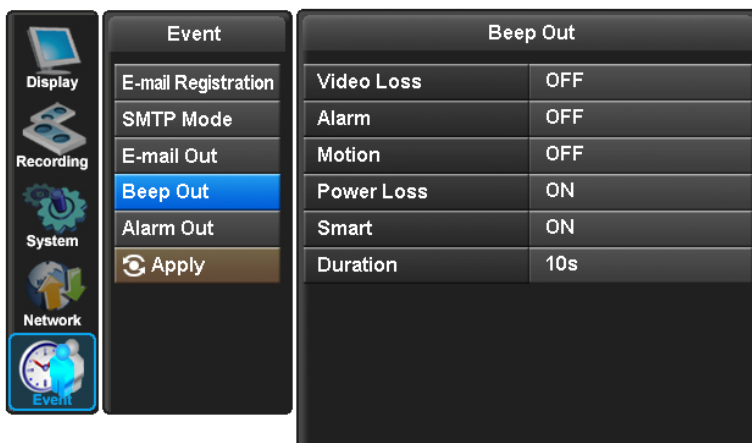

## [ Alarm Out ]

The Alarm out relay can be set to activate on the following occurrences: Video Loss; Alarm input; Motion detection; Power Loss; Smart (Hard disk monitoring).

The duration of the activation can be set.

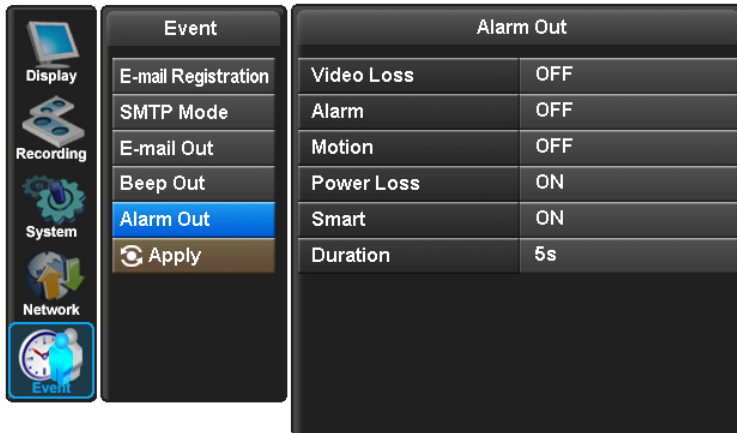

## Search Menu

### 1. Searching Video Footage

To access the search option, press the SEARCH button on the front panel or right click the mouse and select Search, (A password may have to be entered) after which the following screen will be displayed.

#### [ Date / Time Search ]

If you select date/time search, the following will be shown. Use the numerical number on the front panel or the mouse to select the time and date required, then select Play.

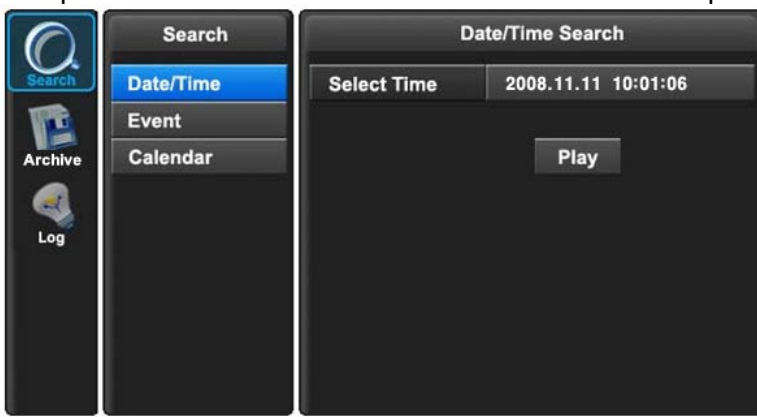

#### [ Event ]

This allows the user to select between ALARM, MOTION or AUDIO. Select required option by pressing the right arrow, or selecting with the mouse.

ALARM – The search is for any alarm activation within the times defined.

MOTION – The search is for any motion events within the times defined.

AUDIO – The search is for any audio activations within the times defined.

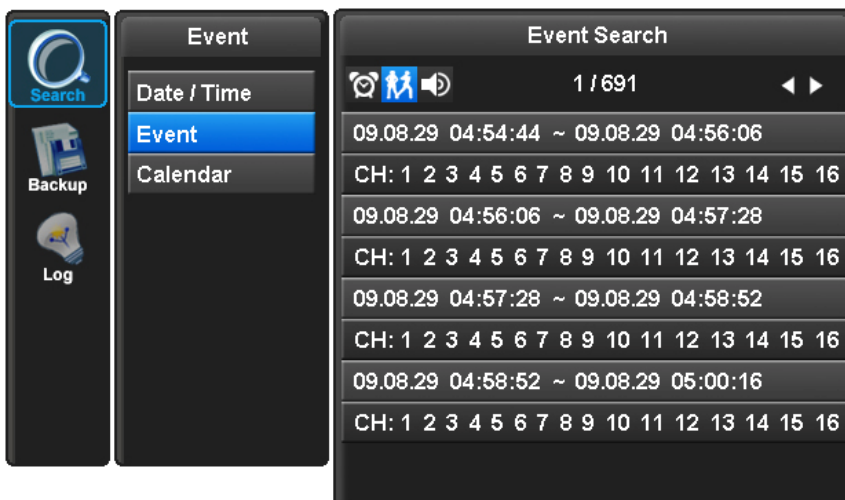

## [ Calendar Search ]

Following screen is displayed when “Calendar” search is selected.



The Calendar search gives a graphical representation of when video is recorded on the hard drive.

The year and month can be selected. This month is shown as a calendar on the screen, any day which contains recorded video will be indicated by a highlighted number in white.

Move to the desired day by using the up / down / left / right buttons, Select the day by pressing SEL.

The following screen will be displayed.

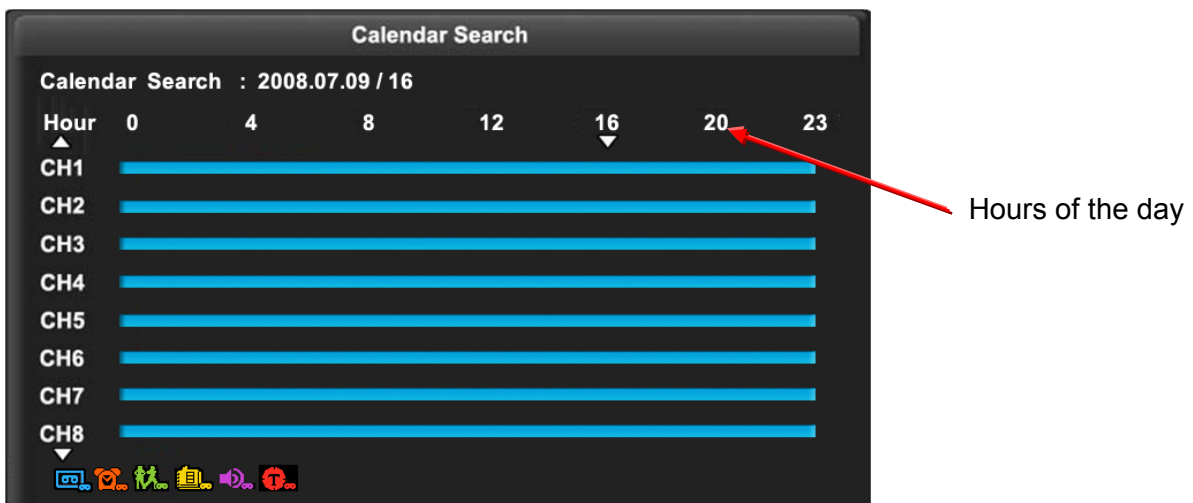

## E4000 installation and user manual

The hours which have recorded data are displayed as a coloured bar. Select the hour which you want to review, the following screen will be displayed.

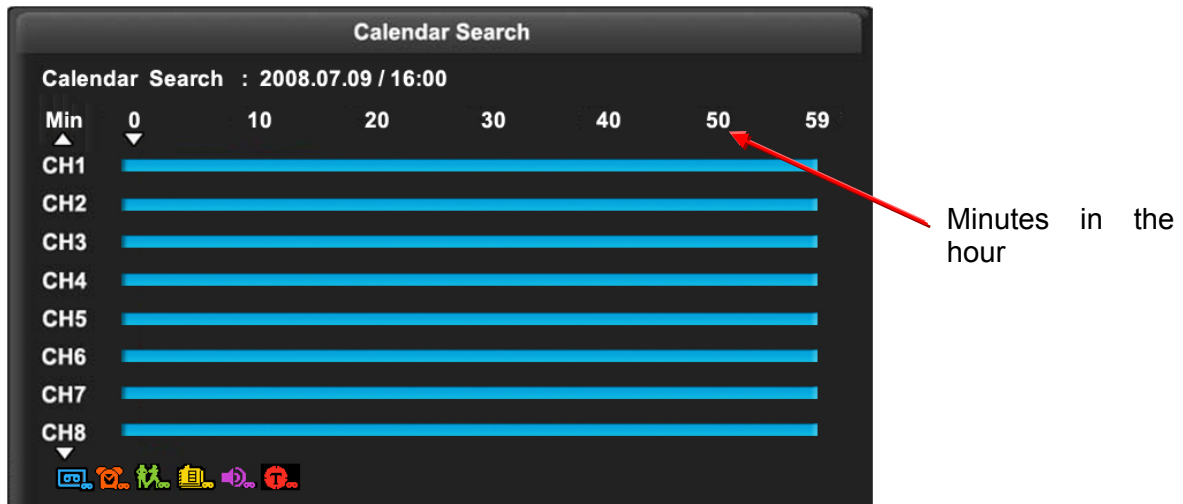

The minutes which have recorded data will be displayed as a coloured bar, click on the time required; the recorded data will be played back from this point.



## 2. Archiving Evidence to DVD/CD or USB

Once the required video has been found, it may be necessary to download it for evidential purposes. This can be done either onto the internal CD/DVD-R writer or via the USB port on the front of the E4000.

To do this press the SEARCH button and using the down button move to ARCHIVE, once highlighted press SEL, the following screen will be displayed.



### Device

This allows selection between the internal CD /DVD-R writer and the FLASH option via the USB port, when highlighted use the right arrow to toggle between the options.

### Device Format

Format for CD/DVD-R is not needed. When using a USB pen, the format should be done first.

### Type

EXCLUSIVE file type

If evidence is downloaded as an Exclusive file, the Quantum Plus will download bespoke player software on to the CD / DVD or USB device along with the evidence. This means that no special software is required, by the reviewing PC. This format is secure and watermarked.

### LOG

The Log file can be downloaded from this menu screen, simply tick the LOG box and do not select any camera channels, then select transfer.

### From/ To

You can set up the start and stop time which is required to be backed up to the internal **CD/DVD-R or USB device.**

Highlight this option, then press SEL, then use the alphanumeric buttons or the mouse to set the time and date. Repeat for the end time.

## E4000 installation and user manual

### Channel

As long as the EXCLUSIVE file format is selected, the number of channels to be down loaded can be selected. Anything from a single channel to all 16 can be selected.

### Calculate Archive size

Once the time and date and file format have been entered, it is necessary to confirm that the size of file created will not exceed the size of memory available on the disk or USB device.

Move to Calculated Archive size and press SEL.

The E4000 will then calculate storage space required for download file. This will be displayed in the Required Size section. As long as the Required Size is smaller than the Free/ total space, then move to Transfer and select it.

### Transfer

When Transfer is highlighted press SEL, the downloading will start. Percentage done during downloading will be shown.

\* USB compatibility: the following have been tested

Lexar JumpDrive	128/256MB
SanDisk Mini Cruzer	128MB
SanDisk Cruzer Micro	256MB, 512GB, 1GB
KINGSTONE	2GB
A-DATA	2GB
IMATION	2GB
MARUZEN	1GB
DVD/RW Plextor	PX-716UFL
Lite-On CD/RW	(LTR-52327SX)

## 3. Log

The log file contains information on the following:

- Power: Power on, Power off, Power fail
- Record: Rec fail, Rec start, Rec stop, Rec error, Rec full
- Operation: Play start, Play stop, HDD format, Menu set
- Client: R\_Login, R\_Logout, R\_Logfail, R\_Play, R\_Transfer, R\_Rec on, R\_Rec off, R\_Upgrade
- Event: Alarm, Motion, Audio, Video loss, Email fail
- Archive: This lists the USER, time/date when Archive was done, and time range of archived section.

A total of 2500 events can be recorded the oldest being overwritten when a new one occurs, they can be viewed all together or as individual types.

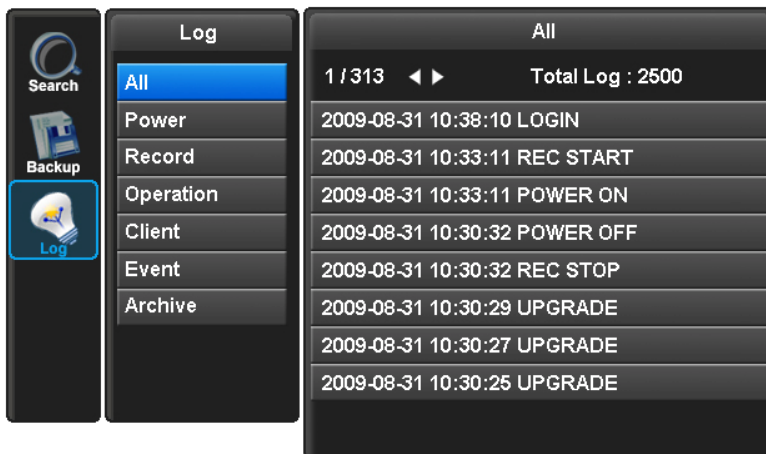

## Client Viewer software

Each E4000 comes with license free viewer software to view the E4000 across a network.

To be able to do this the recommended minimum specification for the PC is as follows:

### Minimum PC specification

- > CPU: Core 2 Duo 1.8GHz,
- > Graphic Memory: 256MB

### Installing software

When you put Quantum Network installation CD into your PC, it will auto run and lead you through an installation wizard. Follow the instructions. Once the software is loaded it will automatically run.

### Connection

To connect to the Unit, open the Viewer Software and click the connection button,





## Explanation of Screen Buttons



## Live Monitoring

The software is best viewed with the PC monitor resolution, set to: 1024 x 768.



### Split Screen options (1, 4, 6, 7, 8, 9, 10, 13,16):

Spilt Screens can be viewed during both live and playback. The splits screens available are: full screen,4,6,7, 8,9,10,13 and 16 way.

#### 1) Full Screen



#### 2) 10 Way





Full Screen on/ off



When the full screen button is selected, a tool bar offering the various split screen options, and the Exit key will be displayed at the bottom of the screen.

OSD on/off:



The OSD button will toggle between the on screen titles etc being shown or hidden

(Smart) Arrange On/Off:



If Cameras are being displayed in segments that are not logical, the Smart button will rearrange and put camera input 1 into segment 1 (Top Left) etc.



Image Save / Load:  / 



**SAVE:** This icon is used to save a still image in either JPEG or BMP or TIF format. There is no change on the main screen when the “Save” icon is pressed.

The still image is stored as default in C: H264CD: Saved folder, as a Jpeg image using the date and time as the file name.

**LOAD:** This icon is used to retrieve and view a saved still image, when selected a list of available images will be shown. Select to one required, it will be displayed along with data information (Status-Live/Playback, IP address, CH No.).

**Playback (Step Backward, Backward, Playback, Pause, Recording, Stop, Step Forward)**



**Audio (Mute, Volume, Select Audio, Microphone)**



Select Audio: Toggles through audio channels.



Microphone: It is used for transmitting audio to the System through a microphone.

## Remote search

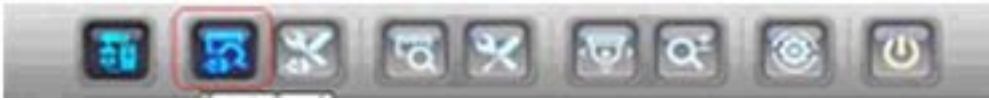

Search (Date/Time/Event/Calendar), Archive (Remote Archive), Log (Remote Log) are available.

## SEARCH

This Remote Search is able to play back video on the PC direct from the hard disk storage on the Quantum Plus. There are 3 options for as follows.

- 1) Date/Time
- 2) Event
- 3) Calendar

### Date/Time



When the cursor is placed over a part of the time and date a drop down arrow will appear, use this to set the required value.

When set.

Click "Play" button, this window disappears and Remote Playback will start.

To stop playing back press Stop  the search screen will appear to allow another search to be carried out, if not required, click cancel followed by live



### Event

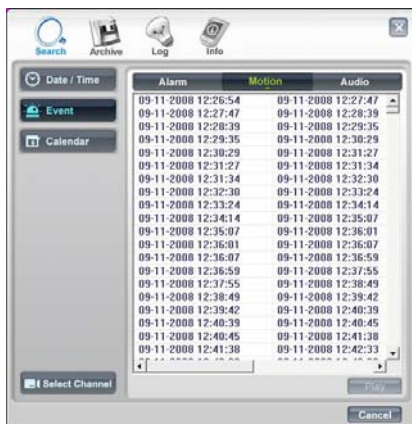

Click on the Event button on the right hand side, the software will search for all event types. This may take a short while.

A list of the available events will appear.  
To play an Event select it and click Play.

To stop playing back press Stop  the search screen will appear to allow another search to be carried out, if not required, click cancel followed by

live .

## Calendar

Select the date required (as long as the date is highlighted in Blue there is recorded data on from that day).



There are 3 options for selecting the required time once the date has been selected.

- 1) Drag the Red line along the colour bar (i.e. Blue: Normal Recording) till the required time is reached.
- 2) Click on the required time for playback on the blue bar then the red line will move to this point.
- 3) Hover over the time box, a drop down arrow will appear allowing the manual selection of Hours, mins and seconds.

Next click the “Play” button for Remote Playback. Or, click “Prev” to go back to previous stage.



## Select Channel:



Channels can be included or excluded dependent on query. This is available within Search, Backup and Logs.

## ARCHIVE

### Remote Archive – Date/Time

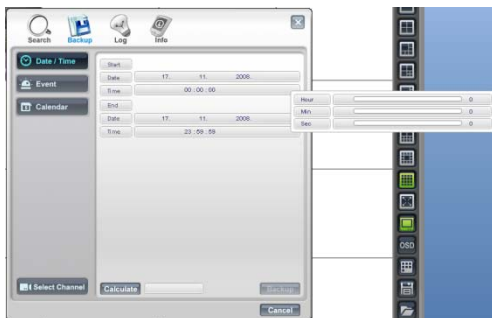

Enter the Start and End dates and times, by hovering over the selections, a drop down box will appear.

Once selection is made, then “click” calculate, the file size will be displayed. Finally click “Archive”, the file will be transferred to C:\H264CD\Download.

### Remote Archive – Event

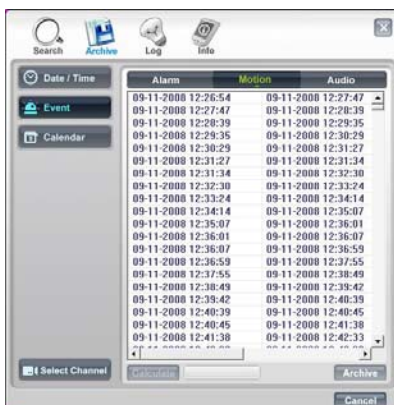

Select either: Alarm, Motion or Audio from the top of the screen. A list of events will appear.

Click on the event required, it will be come highlighted.

Click on Calculate, the file size will be calculated, this may take a few seconds.

Finally click Archive; the file will be transferred to C:\H264CD\Download.

## Remote Archive – Calendar

Select the date required (Days with recorded video a data present are highlighted in **Blue**)



There are 3 options for selecting the required time once the date has been selected.

- 1) Drag the Red line along the colour bar (I.e. Blue: Normal Recording) till the required time is reached.
- 2) Click on the required time for playback on the blue bar then the red line will move to this point.
- 3) Hover over the time box, a drop down arrow will appear allowing the manual selection of Hours, minutes and seconds.

Then click the “Next” button to set “End” Archive time, in the same manner.



The backup procedure is same as Date/Time & Event backup as previous page.



\* "Prev" to go back to previous stage.

\*The downloaded data is saved in the follows location.

C:\H264CD\Download.

## Play back down loaded files

Open the viewer software but do not connect to a unit, click the cancel button to remove the log on box.



Next click on the Local search button the normal search box will appear, use the same method to search the files on the PC and Play back



## Remote Log

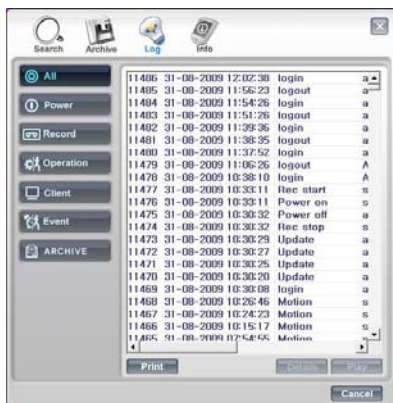

The Log file can either be viewed or printed. The recorded Event can be played, by selecting it and clicking on Play.

The log list can be viewed as a whole or filtered by the following types:

- Power: Power on, Power off,
- Record: Rec fail, Rec start, Rec stop, Rec error, Rec full
- Operation: Play start, Play stop, HDD format, Menu set
- Client: R\_Login, R\_Logout, R\_Logfail, R\_Play, R\_Transfer, R\_Rec on, R\_Rec off, R\_Upgrade
- Event: Alarm, Motion, Audio, Video loss, Email fail.
- Archive: **This is a Password protected section**, only available to users with the correct rights. Click on the Archive button a password entry box will appear, which has to be completed before the Archive log list will appear.

## Info

### - "System Info" of the Remote Log

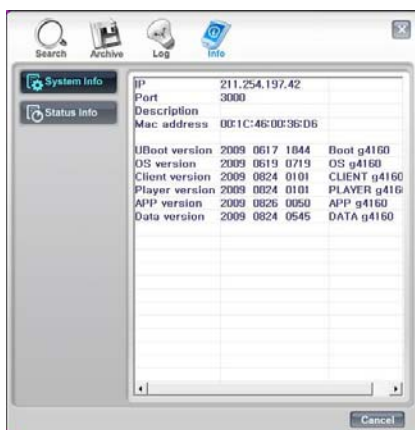

The system info displays the Mac address and software version information.

### - "Status Info" of the Remote Log

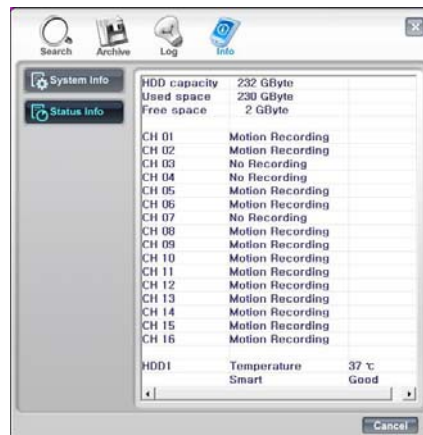

This shows the status of both the Hard disk and the recording modes of each channel.

## Remote Setup: (Menu settings - Same as DVR)



## 1. Display

### Camera Setting

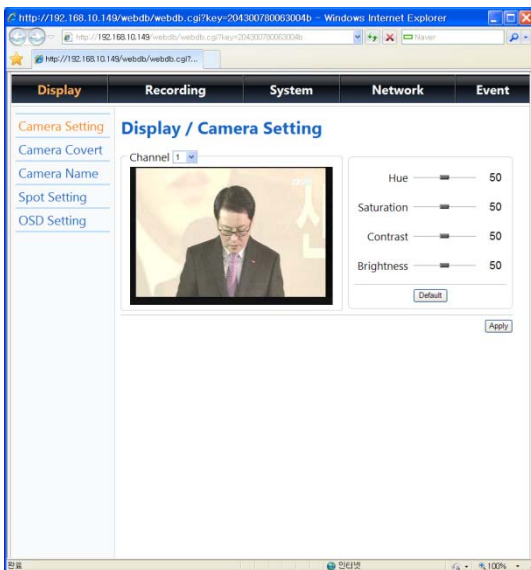

Within this setting the Hue, Saturation, Contrast and Brightness can be adjusted on a camera by camera basis.

### Camera Covert

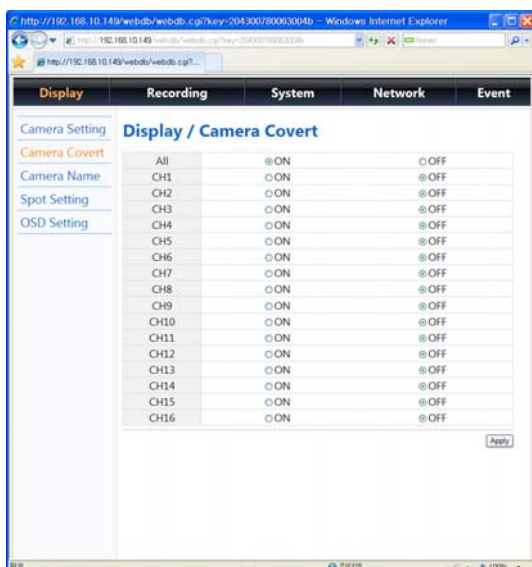

Cameras can be remotely set into Covert Mode, they are still being recorded but cannot be viewed local to the system, or by any remote user apart from the Administrator on line.



## Camera Name



Up to 32 Characters are available for each camera name.

## Spot Monitor settings

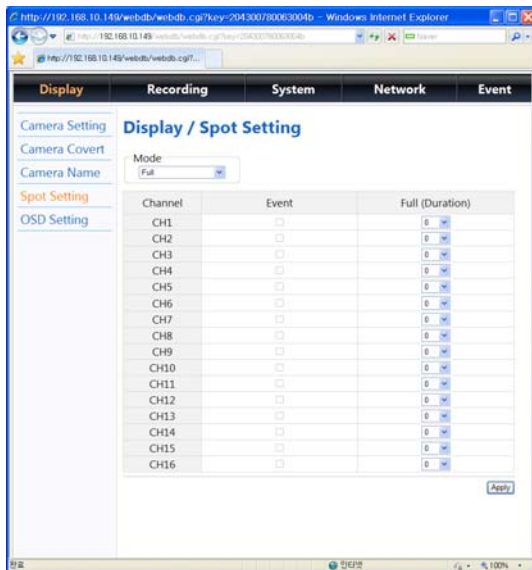

- 1) Set "Mode" (normal screen or Event).
- 2) Next select Duration for a sequence.

## OSD On/Off

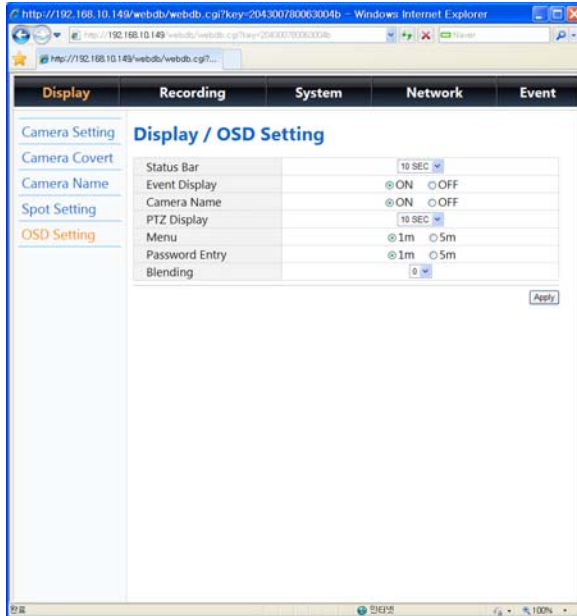

Selecting how long the graphic information is displayed on the screen.

## 2. Recording

### Global

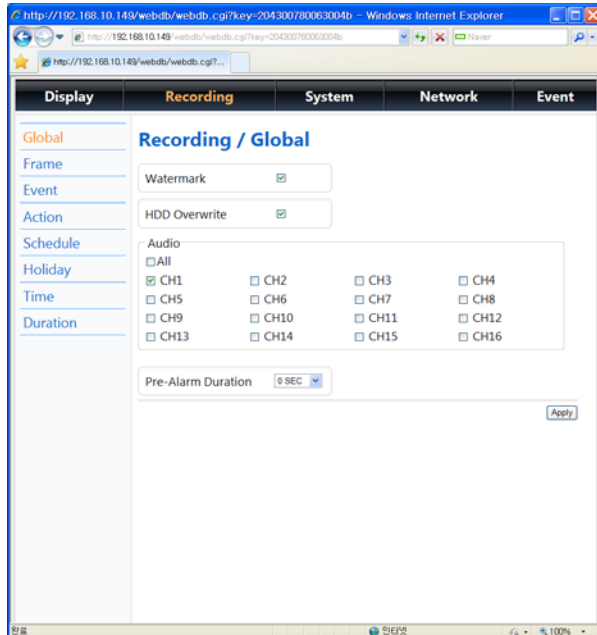

1. Watermark – security tagging of recorded video.
2. HDD Overwrite – When the disk is full it will overwrite the oldest data.
3. The Picture quality can be set
4. Alarm mode can be set between Exclusive and Normal
5. Non- Alarmed resolution – this is the resolution that non alarmed cameras are recorded in during an alarm event
6. Non-Alarmed FPS- this is the rate that non alarmed cameras are recorded in during an alarm event
7. Post-Alarm duration – the period alarm record settings continue for after an event finishes.
8. Pre-Alarm Resolution – Picture quality for pre event recording.
9. Pre-Alarm FPS – Picture rate for pre event recording.
10. Pre-Alarm Duration – Length of pre event.

### Frame

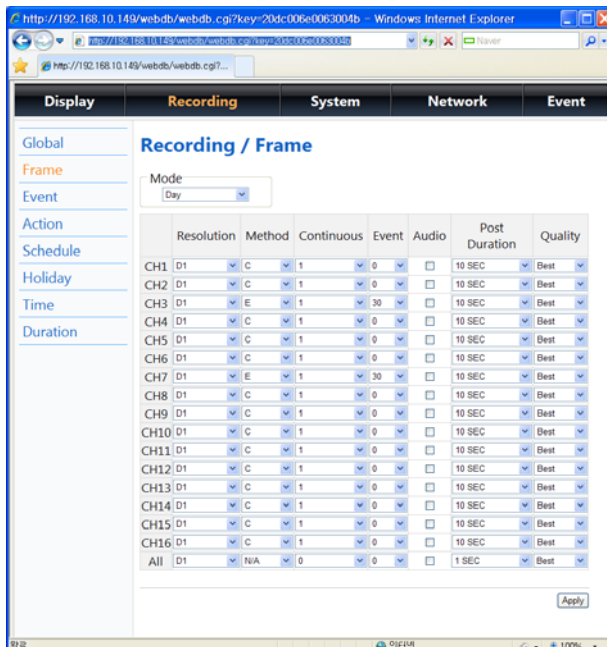

This configures the FPS for each schedule – Day/ Night/ Weekend & Holiday/ Time/ Instant recording.

# E4000 installation and user manual

## Event

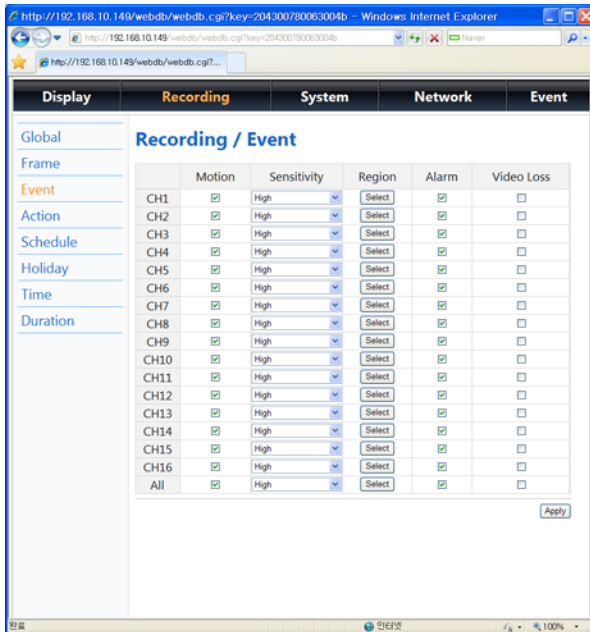

When an event comes in the DVR records the image according to its settings(Frame menu) and triggers an alarm(Action).

## Action



Associate an alarm relay with a channel and enable PTZ camera to move to a preset position when an event occurs.

## Schedule

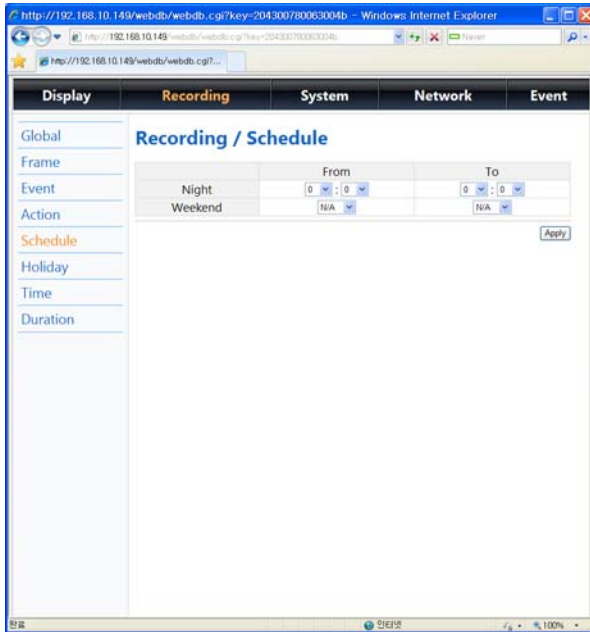

Set night time and define weekend.

## Holiday

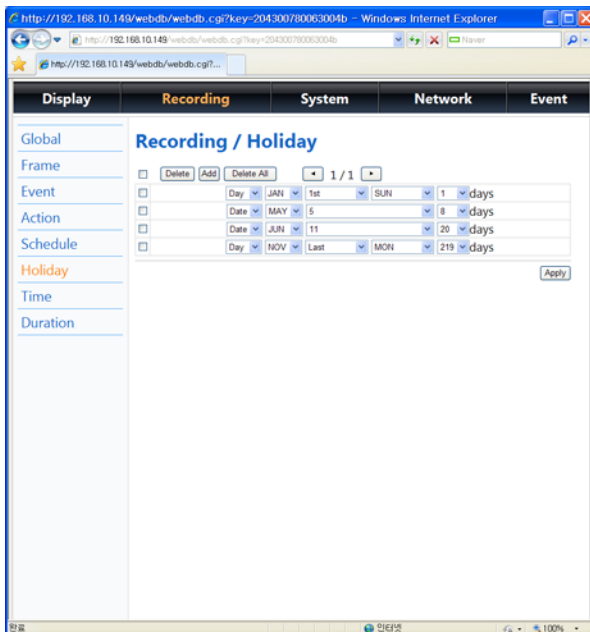

Define holiday.

# E4000 installation and user manual

## Time

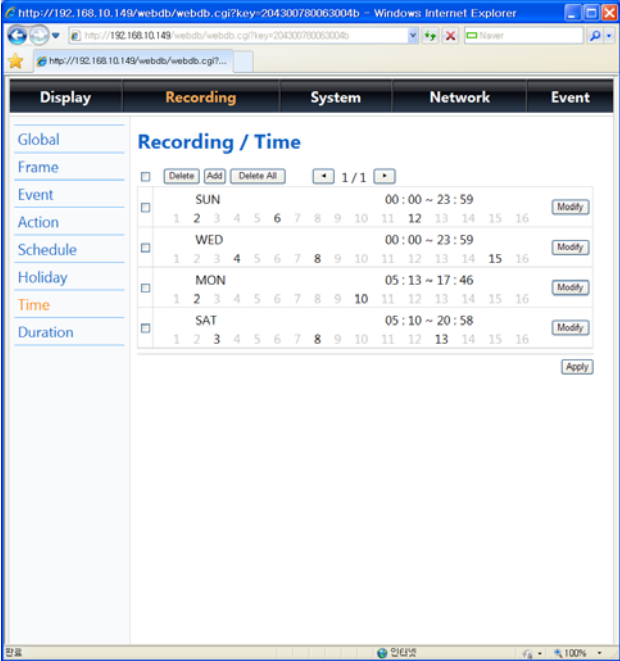

The time recording allows the DVR to be set to only record at particular times of the day.

## Duration

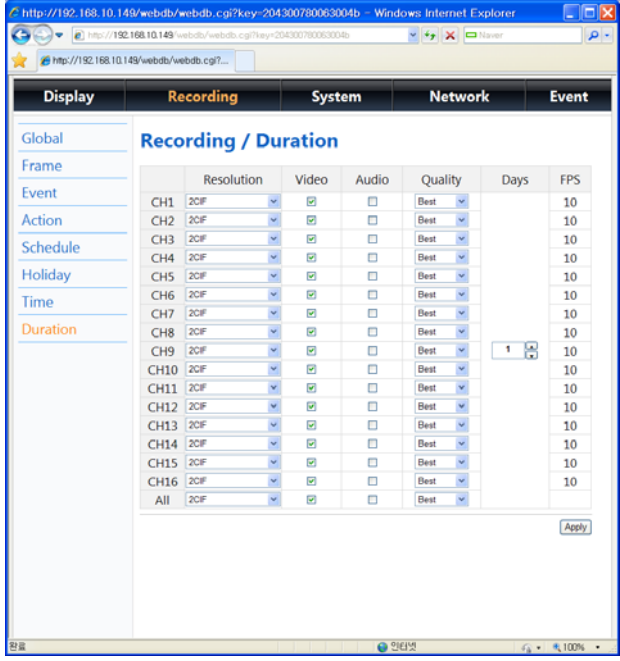

The Duration mode allows the user to set the number of days that they require to record for.

## 3. System

### Basic

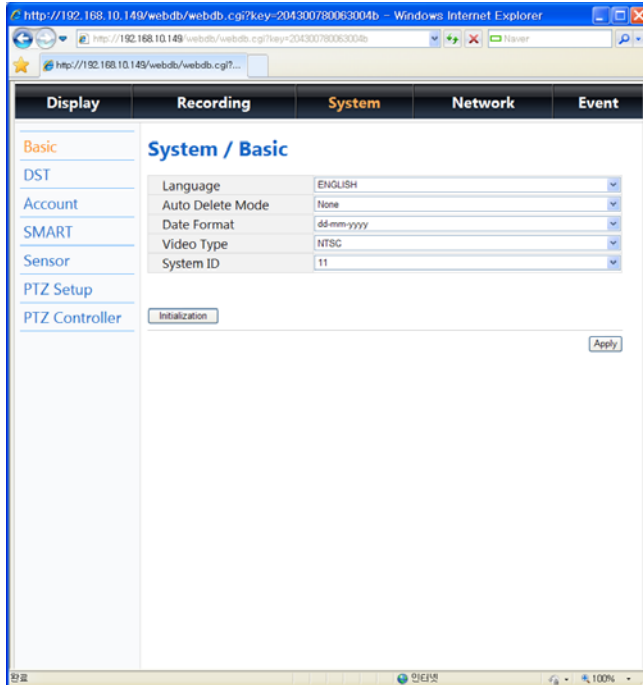

This section is used to select:  
Language  
Date format  
Video type  
System ID  
Live viewing resolution – over the network  
Live Quality – over the network

### DST Setup (Daylight Saving Time)

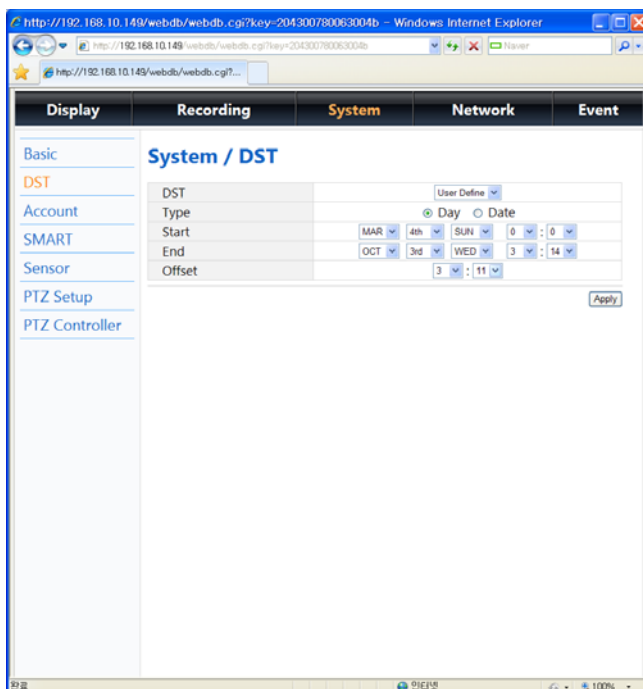

The E4000 can be set to automatically reset its clock when the clocks change for Day Light Saving time. As default this is set to Off.

#### User Define :

Change “Off” to User Define, this will allow the exact date and time for the change to occur. Alternatively

#### Select Region :

Select the required country.

## Account

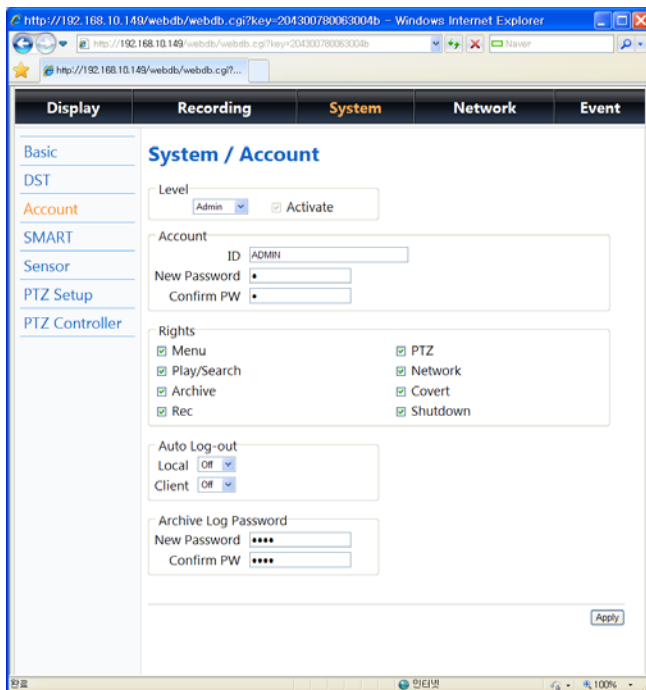

### Editing ID & password

The E4000 allows for :  
1 Administrator level log on  
1 Manger level log on  
25 User level log on

Each of the 27 log-on accounts can be given individual passwords and user rights. User rights can be applied.

### Auto Log out

After a certain amount of time (15mins, 30mins or 1 hour) of inactivity. The users can be automatically logged off both the Local front panel control, and the Client viewer,

### Archive Log password

A password is required in order to access the Archive Log.

## Smart (HDD watchdog)

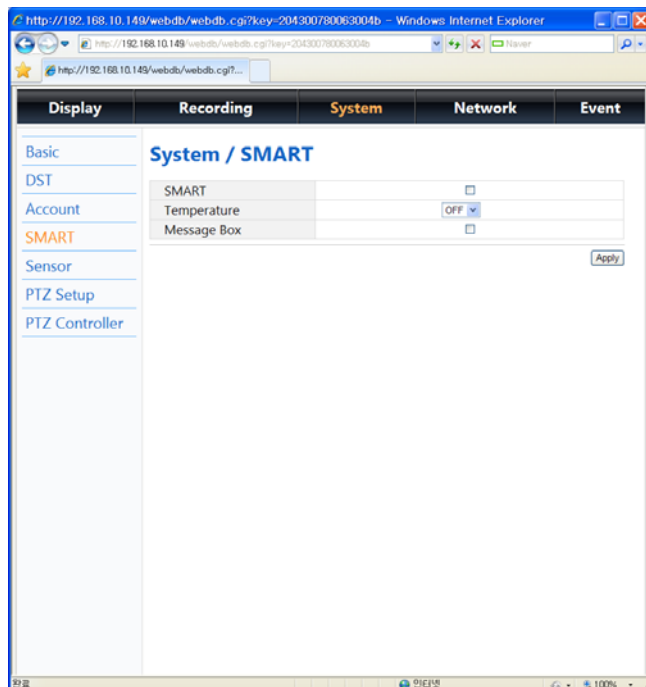

Smart can be turned on or off to monitor the Disk sectors

The temperature can be set 60 to a value, above which it will alarm. The Q Plus is rated to work up to +50 degrees C. It is recommended to set the Temp to approx +45 degrees. This will give the opportunity to take preventative action, such as improving ventilation to the unit.

Message can be turned On or Off, if On a message will appear on the screen to warn of potential problems.



## Sensor

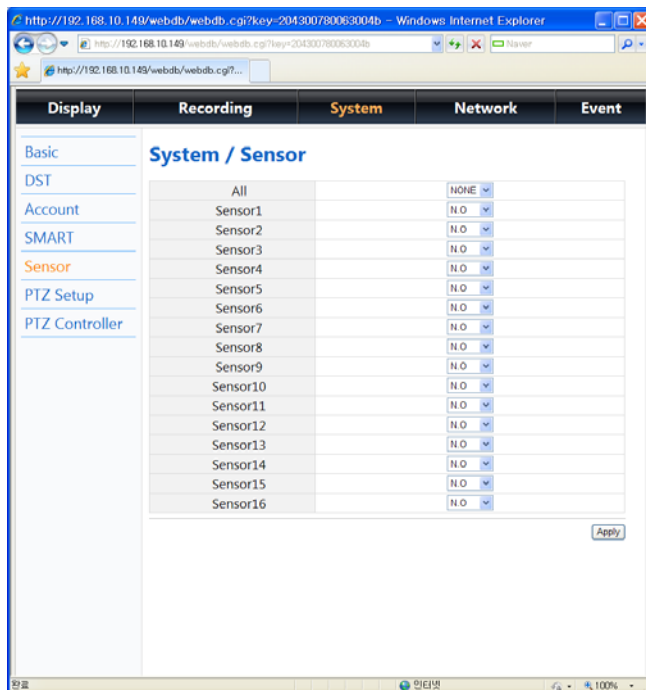

Each of the 16 alarm inputs can be configured to be either inactive (NONE), or Normally Open (N.O), or Normally Closed (N.C).

## PTZ Setup

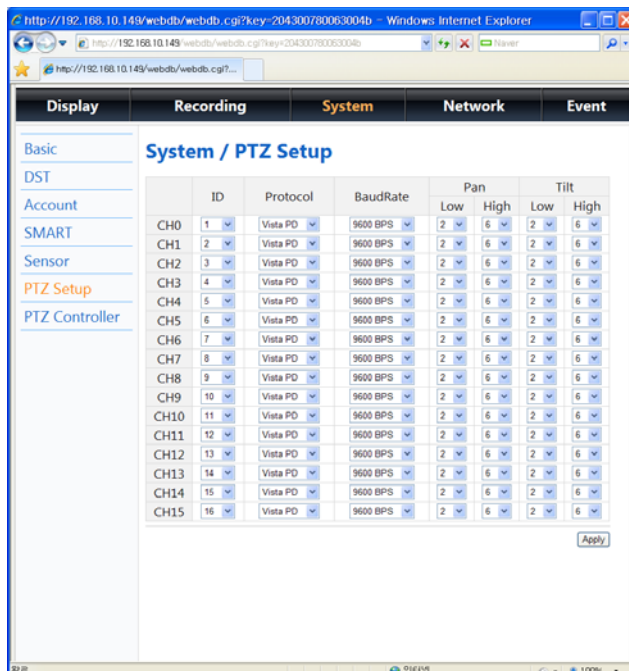

### ID

Each camera input can be allocated an RS485 ID between 1 and 255.

### Protocol

Each camera output can have an individual protocol associated with it.

The Baud rate of each PTZ camera can be set the choices are:

2400/4800/9600/19200bps

## PTZ Controller

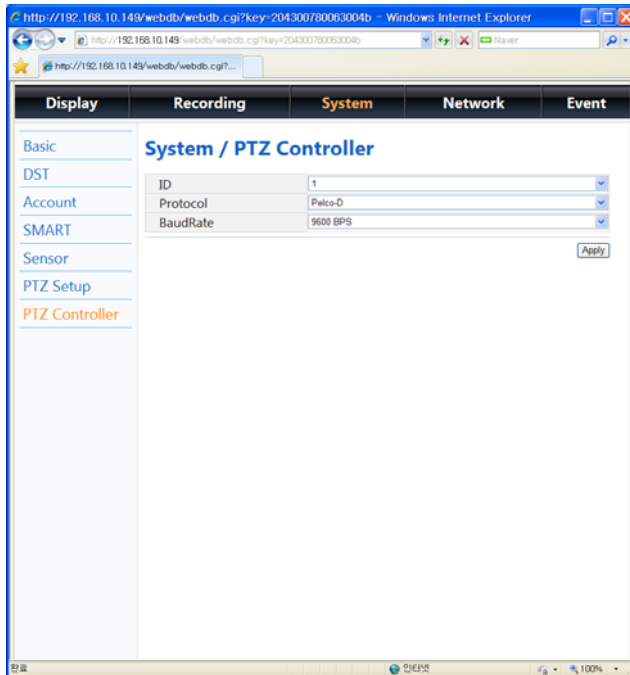

Each Keyboard can be allocated an RS485 ID between 1 and 255.

Each keyboard can have an RS485 protocol associated with it.

## 4. Network

### NTP

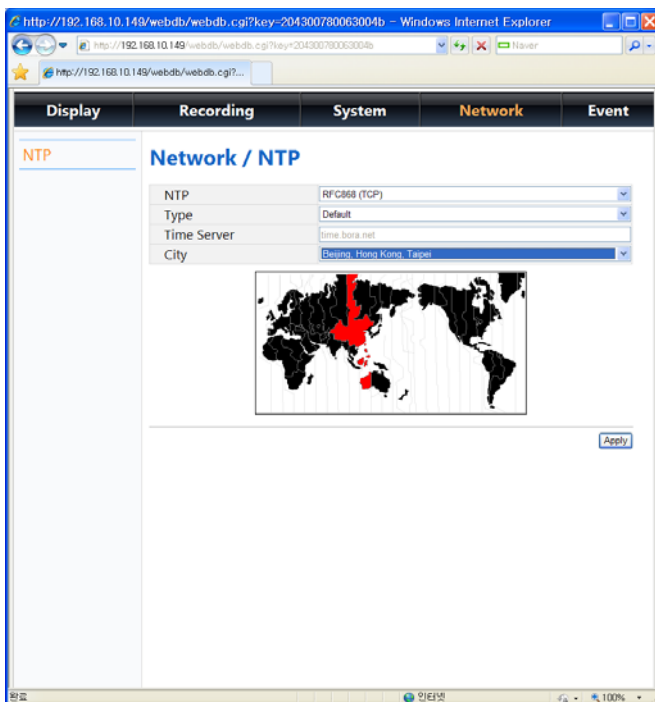

NTP setup allows the DVR to have its internal clock synchronised with an External clock. The default setting is "Off"

Type allows selection between:

**Default** – Time server is "time.bora.net".

**Domain** – Where another time server name can be added.

**IP** – Where an IP address for a time server can be input.

**Select City :**

Once the NTP settings have been set, you must then tell the DVR which time zone you are in. This will allow it to offset any time differences if the time server you contact is in a different zone.

Select City, the map screen will appear. Hover over the city selection box, a drop down arrow will appear, click on the arrow. A list of time zones will be displayed. Select the time zone where the E4000 is located.

## 5. Event

### E-mail Registration

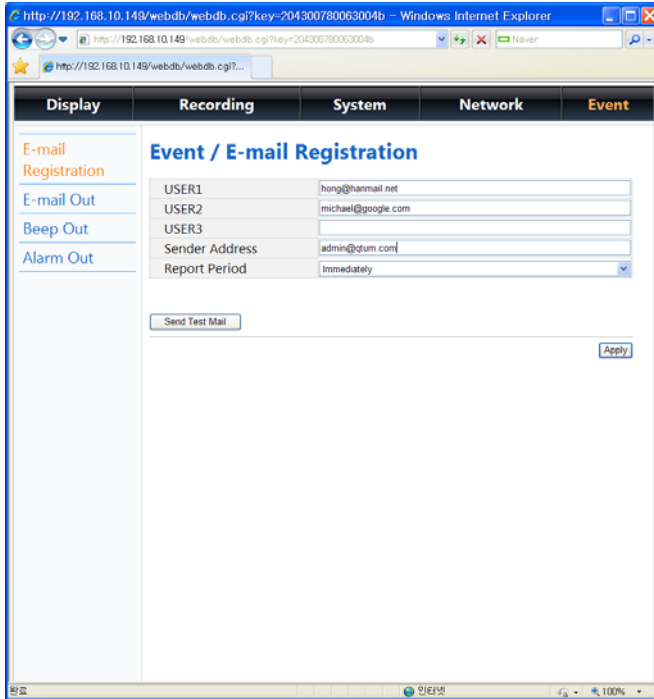

The E4000 will send E-mails to up to 3 defined addresses under certain conditions such as Alarms or video loss. The screen is where you setup the receiving address and address that the DVR will send from.

The mails can be set to be sent immediately an event occurs, Daily or Weekly.

### E-mail Out

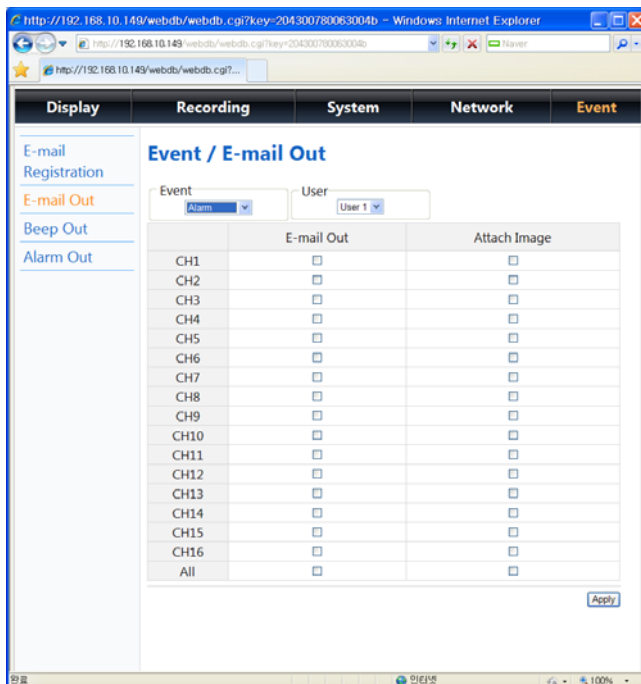

The actions which cause an e-mail response can be defined within this screen.

## Beep Out

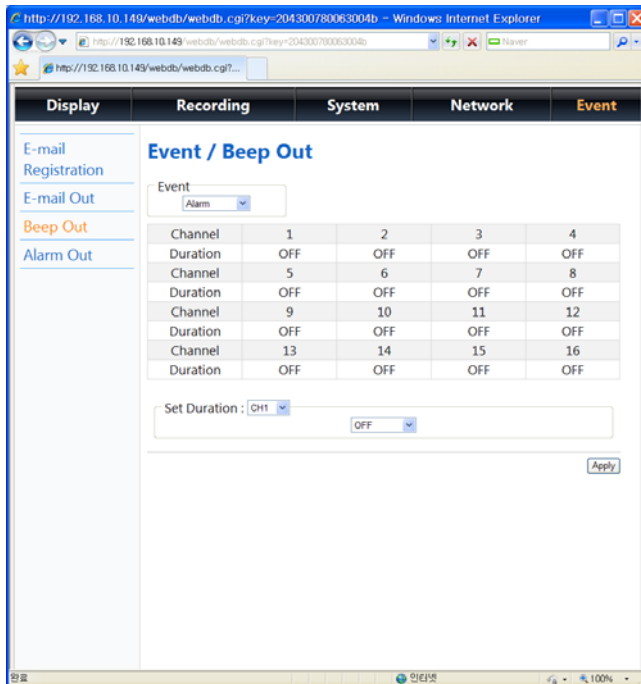

The internal buzzer can be set to sound on the following occurrences:

- Alarm activation
- Motion Detection
- Video Loss
- Power loss

The duration of the buzzer can be set.

## Alarm Out

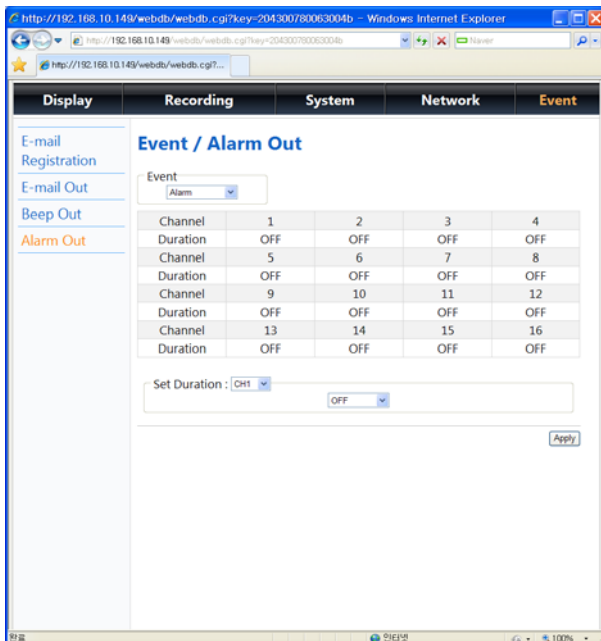

The Alarm output relay can be set to activate on the following occurrences:

- Video Loss
- Alarm activation
- Motion Detection
- Power loss

The duration of the relay closure can be set.

## Local Search (viewing downloaded footage)

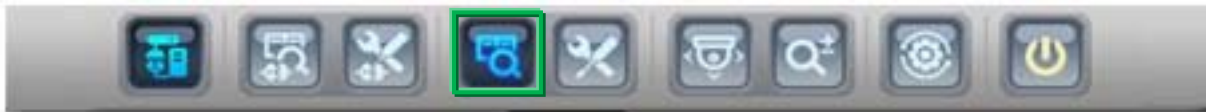

This allows playback of video which has been downloaded to the PC.

### Search

Searches can be done by Date/Time, Event and Calendar.

### Date/Time



Hovering over the Date and Time bars will allow drop down boxes to select the required time and Date.

Once set, click Play.

### Event

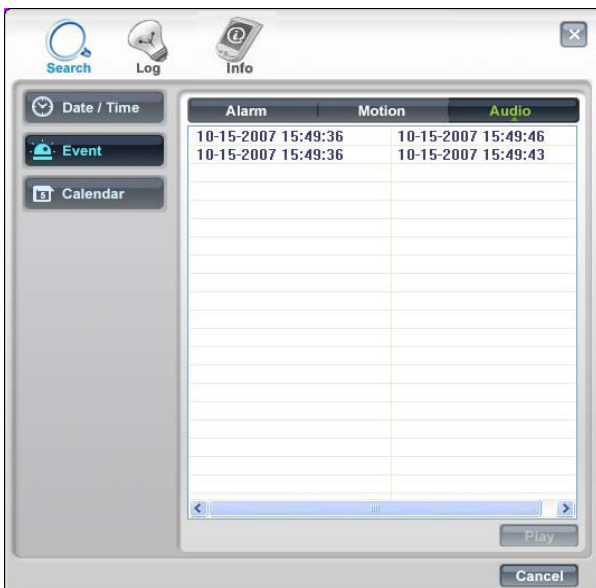

Choose the Event search box then choose the type of Event you are searching for, options are: Alarms, Motion or Audio.

Once the selection is made, a list will appear, choose the Event required and click Play.

## Calendar



When the Calendar option is chosen this screen will appear, any day with recording available will be highlighted in Blue.

Select the required day.

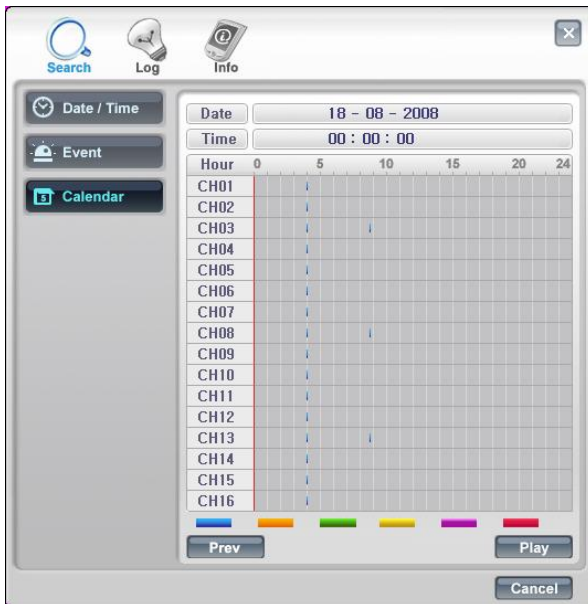

Any downloaded event s will be shown, click on the event, the red line will move to that event. Then click Play to review the recording.



## Local Setup

This allows the setup of the viewing of the software on the PC.



## Global

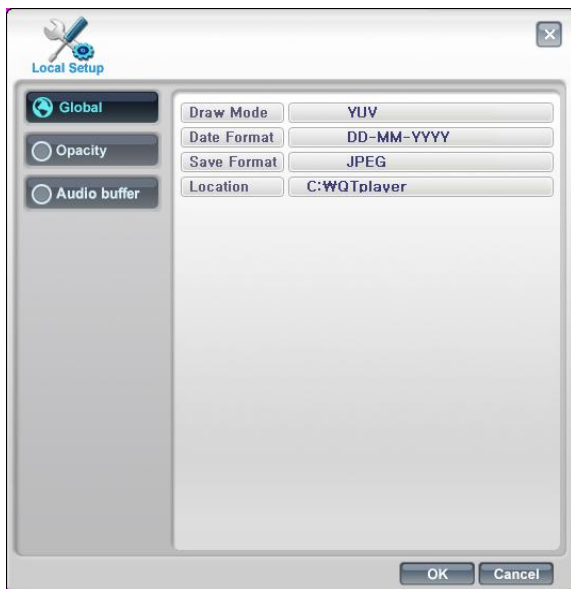

This screen allows the following:

Draw mode to be set to YUV or RGB

Date Format to be set to: DD/MM/YYYY, MM/DD/YYYY or YYYY/MM/DD.

Save Format, for the saving of stills as either JPEG, Bit Map or TIF.

Location for where stills are saved.

## Opacity

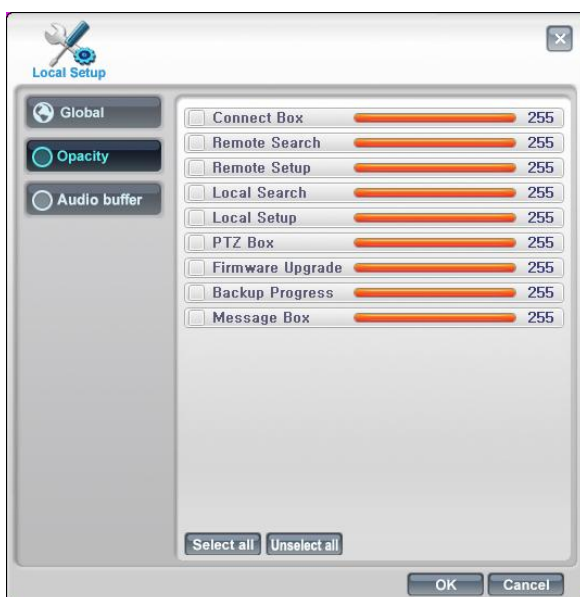

The opacity or “boldness” of the OSD can be individually set per function. The lower the number the more see through the box.



## Audio Buffer

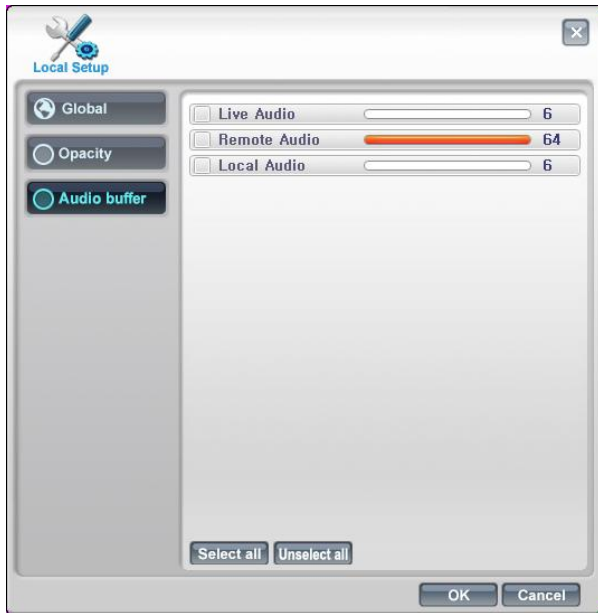

Audio Buffer settings are there to adjust the audio over the network, this will compensate for different network speeds ( LANs, WANs etc).

This can only be adjusted if the LIVE video is switched off.

Adjust each variable to achieve best quality video for Network bandwidth available, this is best done through trial and error.

### PAN, TILT, Zoom, Focus (Remote telemetry control)



When PTZ button is being pressed, PTZ control icon will be pop-up on the live image.

### PAN/TILT/ZOOM/FOCUS



When PAN/TILT button  is clicked the Pan/Tilt control appears, this allows Left, Right, Up and Down Control of PTZ



When Zoom/Focus button  is clicked, the control changes to Zoom in on the up arrow, Zoom out on the down arrow. Focus near on the left button and focus far on the right arrow.

## PRESET/LEARN

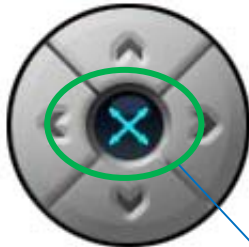

PRESET&LEARN icon



The presets button can be activated by clicking on the centre of the control icon, the preset symbol will appear and the Preset selection box will appear.

To save a preset, move the camera to the desired position then click “Set” followed by the desired number.

To recall the preset, click “Call” followed by the desired number.

## Firmware Upgrade

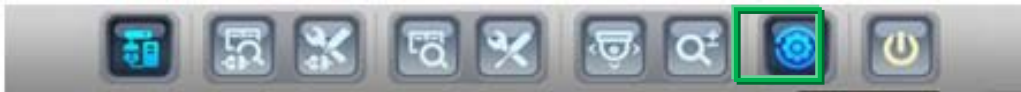

User can select Firmware Upgrade menu, if a new version of firmaware exits in the C:/H264CD/Upgrade folder ,then the message 'New program found!' will be displayed if there is no file then 'New program not found!' message will be displayed.

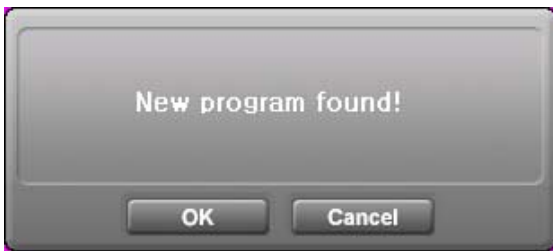

To proceed with upgrading press the OK button and select each firmware files to upgrade it to the system, by ticking the boxes.

Once the upgrade has been completed the following message will appear.

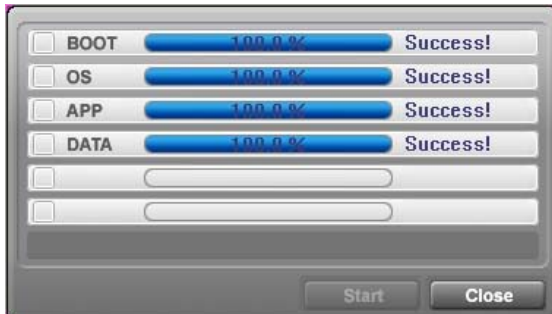

Next press the OK button to reboot the DVR, the firmware will only be applied completely once the system is rebooted.

## Quit (Exiting Client program)



To exit the Client viewer program click the Quit button.

## Appendix 1

### Alarm Sensor Installation

#### 1. Components

- 1) External Sensor : 1
- 2) DVR System : 1

#### 2. Inner Circuit for Sensor Input

The inner circuit of Quantum DVR is as follows,

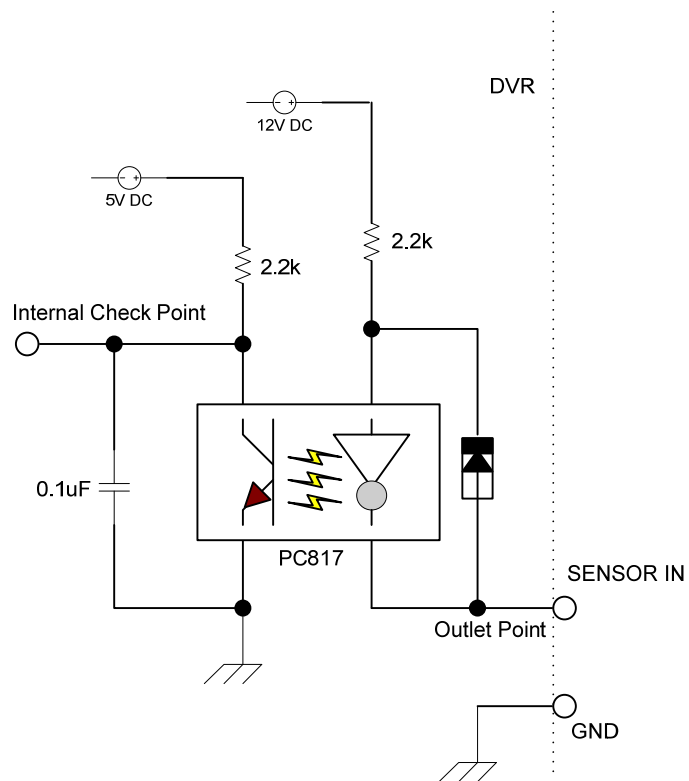

- ① PC817 : Photo Coupler
- ② The Specification of PC817

## ■ Absolute Maximum Ratings

Parameter		Symbol	Rating	Unit
Input	Forward current	IF	50	mA
	*1Peak forward current	I FM	1	A
	Reverse voltage	V R	6	V
	Power dissipation	P	70	mW
Output	Collector-emitter voltage	V CEO	35	V
	Emitter-collector voltage	V ECO	6	V
	Collector current	I C	50	mA
	Collector power dissipation	P C	150	mW
Total power dissipation		P tot	200	mW
*2Isolation voltage		V iso	5 000	V rms
Operating temperature		T opr	-30 to +100	°C
Storage temperature		T stg	-55 to +125	°C
*3Soldering temperature		T sol	260	°C

\*1 Pulse width ≤ 100 μs, Duty ratio : 0.001

\*2 40 to 60% RH, AC for 1 minute

\*3 For 10 seconds

## ■ Electro-optical Characteristics

Parameter		Symbol	Conditions	MIN.	TYP.	MAX.	Unit
Input	Forward voltage	V F	IF = 20mA	-	1.2	1.4	V
	Peak forward voltage	V FM	IFM = 0.5A	-	-	3.0	V
	Reverse current	IR	V R = 4V	-	-	10	μ A
	Terminal capacitance	Ct	V = 0, f = 1kHz	-	30	250	pF
Output	Collector dark current	ICEO	V CE = 20V	-	-	10 <sup>-7</sup>	A
Transfer characteristics	*4Current transfer ratio	CTR	IF = 5mA, V CE = 5V	50	-	600	%
	Collector-emitter saturation voltage	V CE( sat)	IF = 20mA, I C = 1mA	-	0.1	0.2	V
	Isolation resistance	R ISO	DC500V, 40 to 60% RH	5 x 10 <sup>10</sup>	10 <sup>11</sup>	-	Ω
	Floating capacitance	Cf	V = 0, f = 1MHz	-	0.6	1.0	pF
	Cut-off frequency	fc	V CE = 5V, I C = 2mA, R L = 100 Ω, -3dB	-	80	-	kHz
	Response time	Rise time	t r	V CE = 2V, I C = 2mA, R L = 100 Ω	-	4	18
Fall time		t f		-	3	18	μ s

## 3. SENSOR Install Processing

- ① Please refer the below block diagram.

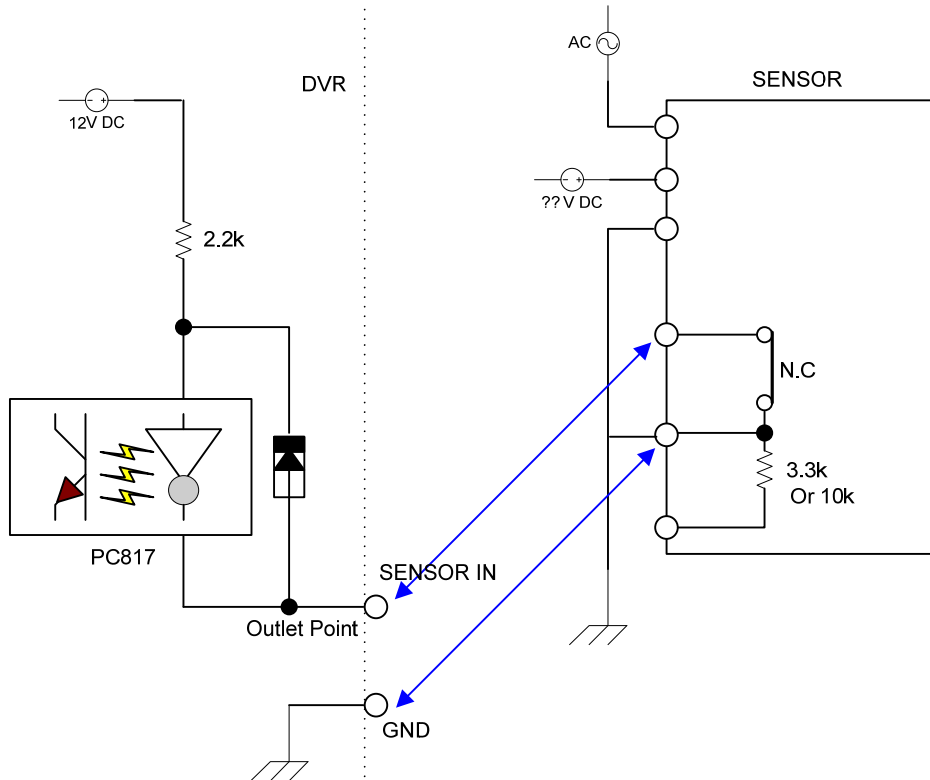

## Appendix 2

### Dynamic IP (Supporting DDNS Server)

With DDNS Server, This allows a user to connect to the unit remotely without the need for a fixed IP address.(Please register your ID & Domain at [www.ddns-dvr.com](http://www.ddns-dvr.com) in which you can use their DDNS server as free of charge)

1. Visit [www.ddns-dvr.com](http://www.ddns-dvr.com) to get the DDNS user ID & PW as well as Host name.

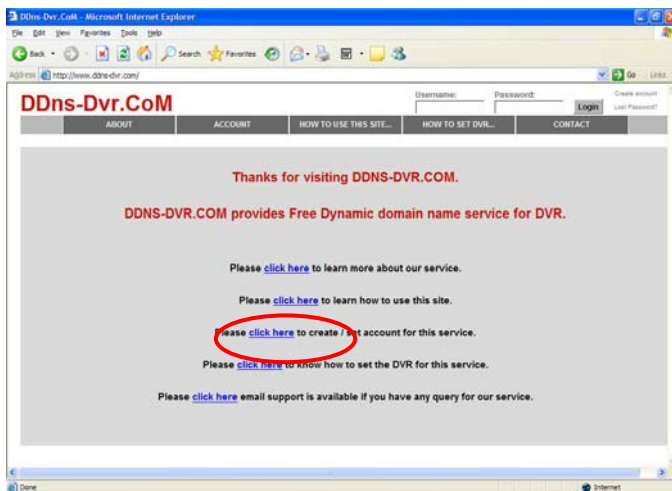

2. Click to create / set account of “Dynamic DNS”.

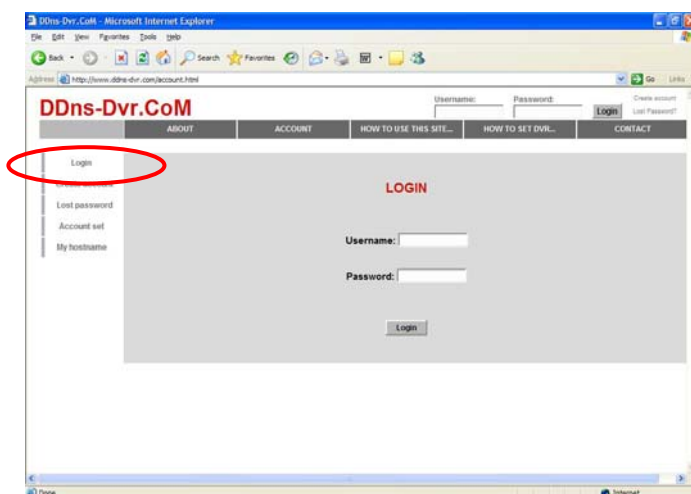

3. Select “Create Account” menu.



# E4000 installation and user manual

## 4. Create Account.

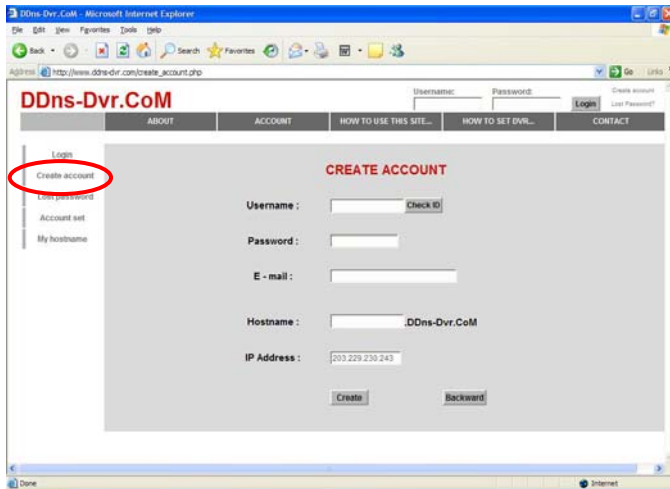

Fill in all blanks in order to create new account.

ID & Password will be emailed to you when the account is setup correctly.

Once the DDns-Dvr account has been setup, it is necessary to add the details in the Network section of the E4000's menus.

### DDNS SET

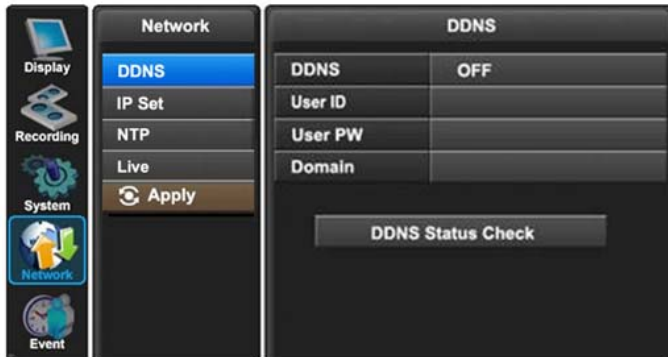

To enter Network set menu, system ask password (Default is 00000000).

In DDNS environment, need to be changed DVR & Web server port, please refer to IP set.

### **Set up DDNS**

1. Change DDNS to ON
2. Input User ID
3. Input User PW
4. Input Domain
5. Click "DDNS Status Check" if it is "ok" Click "Apply"

>> Note : In DDNS Setup, The Domain Name has to be filled in.

## Appendix 3

### Setup For DVR Port/ Web Server Port Using IP Sharing Router (Port Forwarding)

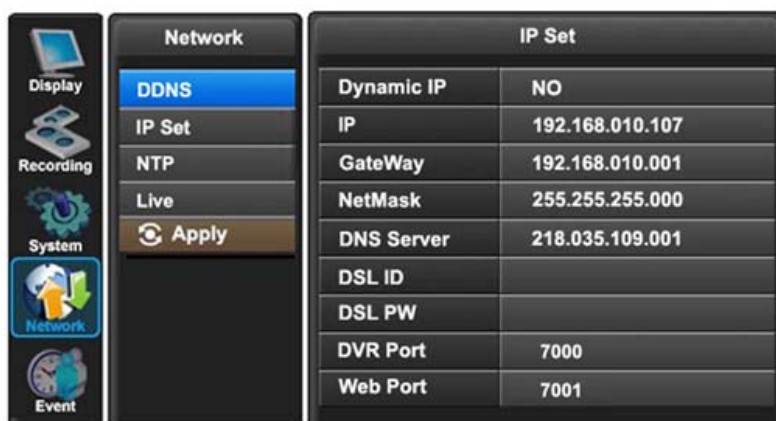

- 1) To use IP sharing router, "Dynamic IP" should be set to "NO".
  - DVR Port : This can be set to any number between 2000 to 65535.
  - Web Server Port : This can be set to any number between 2000~65535, as long as it is not the same as the DVR Port number.

#### 2) Setup "virtual server" on IP sharing Router

It is for setting virtual server to forward IP which is allotted to DVR.

> For example,

DVR-1, IP : 192.168.10.107, DVR Port : 7000, Web Server Port : 7001

If DVR-1 is configured as above, the virtual server on IP sharing router is as follows.

- ① PC Server Name : DVR-1(IP 192.168.10.107)

Protocol : TCP, Internal Port : 7000, External Port : 7000

- ② PC Server Name : DVR-1 (IP 192.168.10.107)

Protocol : TCP, Internal Port : 7001, External Port : 7001

\* For more detail, please refer to relevant IP sharing manual.

- ③ 'DDNS' Setup on IP sharing router

DDNS configuration is not needed in case of fixed IP.

- ④ To connect DVR-1 with Internet Explorer, <http://dvr-1.ddns-dvr.com:7001>

To connect DVR-1 with CD installer, <http://dvr-1.ddns-dvr.com:7000>

## Appendix 4

### Specification

Model			E4000	
			8 Channel	16 Channel
Video	Camera Input(NTSC,PAL)		8	16
	Output		1 BNC, 1 VGA, 1 SPOT	
Audio	Audio Input		1 RCA	
	Output		1 RCA	
Sensor In / Alarm Out			8/1	16/1
Operating System			Embedded Linux OS	
Display	VGA Resolution		SXGA / 1280 * 1024	
	BNC Resolution		720*480 (NTSC) / 720*576 (PAL)	
	Split Screen		1,4,8	1,4,8,16
Recording	Compression		H.264	
	Resolution(Pixel)		720*480, 720*240, 360*240 (NTSC) / 720*576, 720*288, 360*288 (PAL)	
	Picture Quality		5 Steps (Best, Good, Standard)	
	Mode		Normal / Motion / Alarm / Instant / Schedule / Holiday / Time	
	Speed	Total	NTSC	120(720x480),240(720x240) 240fps(360x240)
PAL			100(720x576),200(720x288) 200fps(360x288)	100(720x576),200(720x288) 400fps(360x288)
Playback	Display		1,4,8	1,4,8,16
	Search Mode		Date & Time, Calendar, Event(Alarm, Motion)	
	Speed		Normal, REW(x1/2/4/16/32) & FF(x1/2/4/16/32/64), Frame to Frame, Pause	
	Device		Internal HDD / e-SATA storage	
Network	Network Interface		Ethernet / Mobile	
	Protocol		TCP/IP, SMTP, HTTP, DHCP, PPPOE(ADSL)	
	Serial Communication		RS-232 x1, RS-485 x2 (PTZ & Keyboard Control)	
	Web Browser		Internet Explorer 5.0 Higher (DVRs Control or Viewing)	
	Event Transport		E-mail notification with JPEG when Event Occurs	
Archive	Viewing		Remote Client, CMS, Mobile view	
	Interface		USB 2.0 x2	
Control	Archive Device		External HDD, CD&DVDRW, Memory Stick	
	Motion Detection		Area : Programmable motion detection area for each camera individually Sensitivity : 3 Steps for each channel	
	Alarm Hold Time		1~998 SEC	
	Event Log		Up to the 1000 events (Alarm/ Motion/ Video&Power Loss/ Power&Record On/Off)	
	Controller		IR Remote Control / Mouse	
	Pan/Tilt Camera		Control From RS485 Interface	
Others	HDD		Support internal HDD up to 2TB / external eSATA Storage	
	Power Source		12V DC / 3.3A	
	Power Consumption		30W	
	Weight		3.0Kg(Net) / 5.0Kg(Gross)	
	Dimension		355(W)x250(D)x72(H)mm/Net , 400(W)x340(D)x145(H)mm/Box	

Subject to change without notice

QTUM