

USER'S MANUAL

960H DVR DIGITAL VIDEO RECORDER

For safe use of system and to prevent product failure or accident, please read this manual carefully before use.

Ver 960H_ENG_1.1

Before Usage





This product has been designed and manufactured to assure personal safety. Improper use can result in electronic shock or fire hazard. The safeguards incorporated in this product will protect you if you observe the following procedures for installation, use, and servicing.

This product does not contain any parts that can be repaired by user.

[Note]

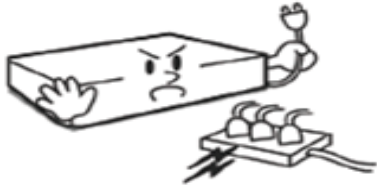
Some contents of this manual are subject to change for function improvement.

Note of Caution

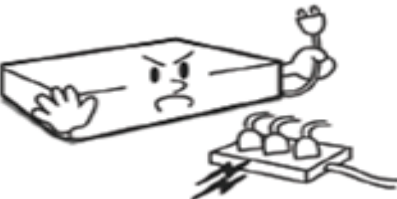
Warning	
<p>Check if the power is switched off before installation. Don't plug in at the same time. Otherwise it may be set on fire or put you at the risk of electrocution or damage.</p> 	<p>Check if the power is switched off before installation or additional repair. Never plug in while the device is in operation. Otherwise it might be set on fire or put you at the risk of fire, electrocution and damage.</p> 
<p>Keep the cables at least 15 centimeters away from the wall and at least five centimeters away from the side so that the cables, including power line and video cable, may not be disfigured. Otherwise it might put you at the risk of fire, electrocution and damage.</p> 	<p>Never uplift the cover, break down, repair and maintain at your disposal. Otherwise it might put you at the risk of fire, electrocution and damage.</p> 
<p>Keep the device environment always clean before and after installation of the device. Use dry cloth to clean the device. Never use any organic solvent. Otherwise it might be the cause of electrocution or mechanic disorder.</p> 	<p>Input voltage of the device should come within the range of 10 percent of specified voltage. Use separate wall power to keep heating appliances, including hair dryer, iron and refrigerator. Otherwise it might be the cause of fire and electrocution.</p> 

DIGITAL VIDEO RECORDER MANUAL

When strange noise or smell is sensed, immediately plug out and send inquiry to service center or seller.



Do not install device in humid place filled with dust. It might be the cause of electrocution and fire.



Caution

Do not install the device in any place where strong magnetic flow, electric wavelength and vibration may be sensed or where radio, TV or other wireless device is located. Keep the device away from magnetic flow, electric wave or vibration.

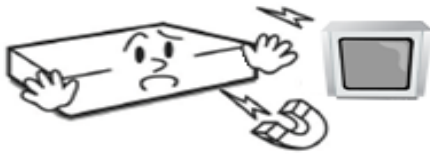

Do not put anything heavy on the product. Otherwise it may be the cause of disorder.



Strong shockwave or vibration may be the cause of mechanic disorder. Please be careful.



Be careful so that anything conductive may not fall into the ventilation hole. Otherwise it may be the cause of disorder.



Check if power switch and record on the front side of the product is still turned on.

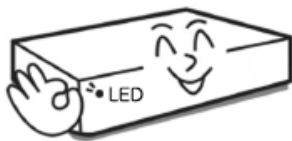

When HDD is overloaded, you change the setting to keep recording. In that case, check again if it would be OK to eliminate the saved data.

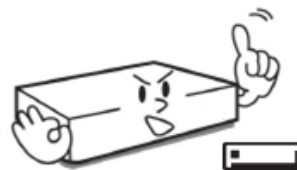

DIGITAL VIDEO RECORDER MANUAL

When HDD saving data gets old enough, video data to be saved may suffer so much damage that it may be irreparable. If screen appears broken while regenerating data saved in HDD, it means HDD won't work any longer. Immediately contact service center to replace them.

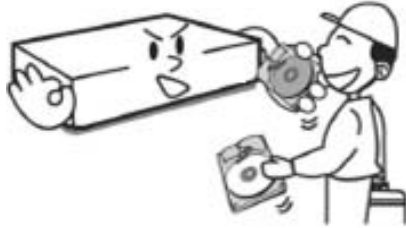

When any abnormal sign is detected, Immediately contact seller or service center.

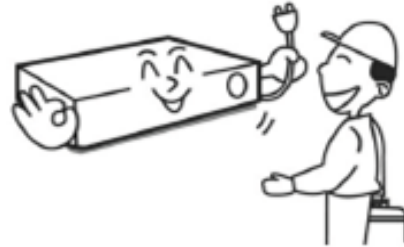

Caution : Any changes or modifications in construction of this device which are not expressly Approved by the party responsible for compliance could void the user's authority to operate the equipment.

Note : This Equipment has been tested and found to comply with the limits for a Class A digital A digital device, pursuant to part 15 of the FCC Rules. These limits are designed to provide reasonable protection against harmful interference when the equipment is operated in a commercial environment. This equipment generates, uses, and can radiate radio frequency energy and, if not installed and used in accordance with the instruction manual, may cause harmful interference to radio communications. Operation of this equipment in a residential area is likely to cause harmful interference in which case the user will be required to correct the interference at his own expense.

Warning ;

This is a class A product. In a domestic environment this product may cause radio Interference in which case the user may be required to take adequate measures.

Check Components

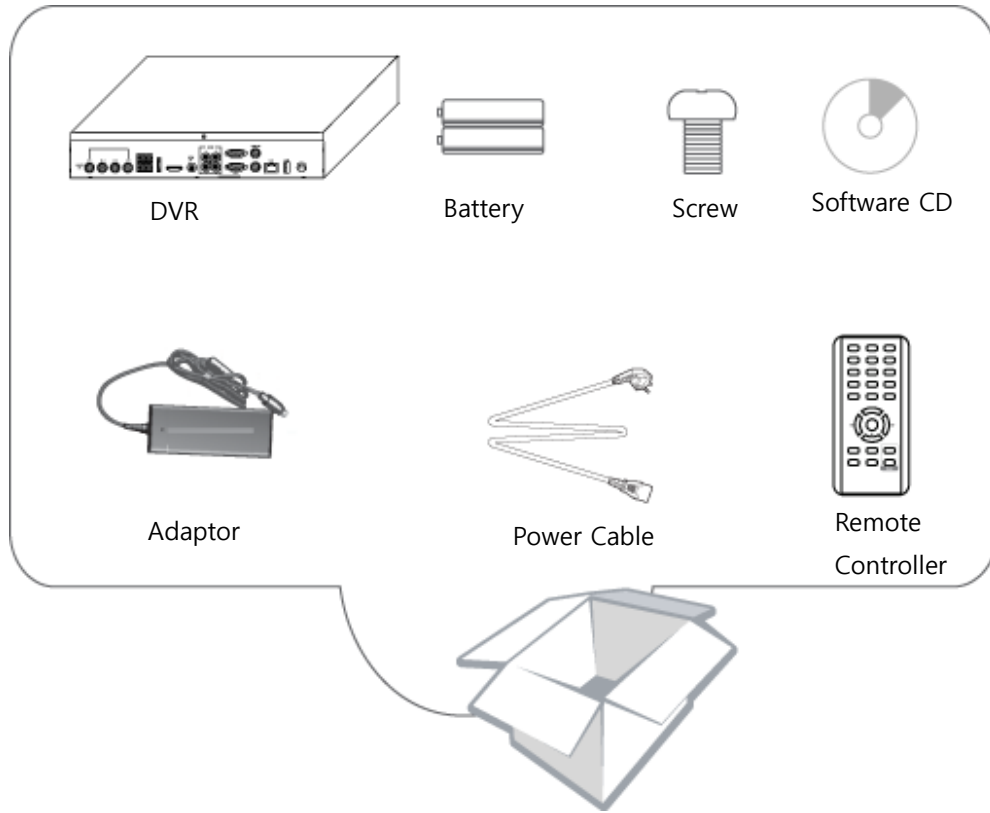

Component	Description
DVR	Stand Alone Digital Video Recorder
Battery	1.5V (AAA) 2 PCS.
Screw	For HDD mounting
Software CD	Manual and Client program
Adapter	DC 12V 5A
Power Cable	Power cable
Remote Controller	For DVR operation

- Contents -

Chapter 1. Features & Components

1-1 Features.....9

1-2 Name and function of front panel.....10

1-3 Rear panel.....11

1-4 Remote Controller.....12

Chapter 2. Basic Information

2-1 Menu Display.....16

2-2 Description of Icon.....16

2-3 Remote Controller.....18

2-4 How to set remote controller ID.....20

2-5 How to display menu..... 21

2-6 Zoom In/Out..... 22

Chapter 3. System Configuration

3-1 Information.....22

3-2 Time/Date.....23

3-3 Password.....25

3-4 Hard Disk.....25

3-5 Default Setup.....27

3-6 Upgrade.....27

3-7 Button Setup.....28

3-8 RS-485.....28

Chapter 4. Display

4-1 OSD.....29

4-2 Split Mode.....29

4-3 Auto Sequence.....32

4-4 TV Adjustment33

4-5 Spot Out.....33

Chapter 5. Network Setup

5-1 IP Address.....34

5-2 Notification.....35

DIGITAL VIDEO RECORDER MANUAL

5-3 Email Notification.....	36
5-4 Web Server.....	36
5-5 Free DDNS.....	37
5-6 Dual Codec Setup.....	37
 Chapter 6. Camera	
6-1 Camera Setting.....	38
6-2 Camera Title.....	38
6-3 PTZ Setting.....	39
6-4 How to use PTZ.....	40
 Chapter 7. Record	
7-1 Record Setting.....	42
7-2 Weekly Record.....	43
7-3 Holiday Record.....	44
 Chapter 8. Event Setup	
8-1 Sensor.....	45
8-2 Motion Detection.....	45
8-3 Event Action.....	46
 Chapter 9. Search	
9-1 Search Menu.....	48
9-2 Calendar Search.....	49
9-3 Date/Time Search.....	50
9-4 Event Search.....	51
9-5 Go to first/ Go to last.....	51
9-6 Search Control.....	52
9-7 Audio.....	52
 Chapter 10. Backup	
10-1 Backup.....	53
 Chapter 11.Remote Connection – iPhone.....	58
 Chapter 12.Remote Connection – Android Phone.....	66
 Chapter 13.Specification.....	77

■ Chapter 1. Features & components ■

1-1. Features

The highly advanced and high-performance video recorder is designed to make it easier to install and use with safety.

Main feature

- Able to control the PTZ by using mouse like joystick
- Front USB port for easy backup
- Able to back up by ODD (optional)
- Support GIGA bit Ethernet.
- Able to access internet with dynamic IP address
- Support Dual-Stream network transmission.
- TV out, VGA out, HDMI, Spot out
- E-SATA, external HDD can be connected
- Able to set the resolution, frame and quality per channel.
- Support a number of PTZ protocol
- Support Central Monitoring Software (CMS).

Application Range

- √ Banks, ATM machine, supermarket, convenience store and other places
- √ residential area, apartment buildings, jewelry store, commercial building
- √ places requiring safety for children such as school, elementary school and playground
- √ warehouse, storage house and workplace
- √ Places requiring remote surveillance

1-2. Name and Function of Front Panel

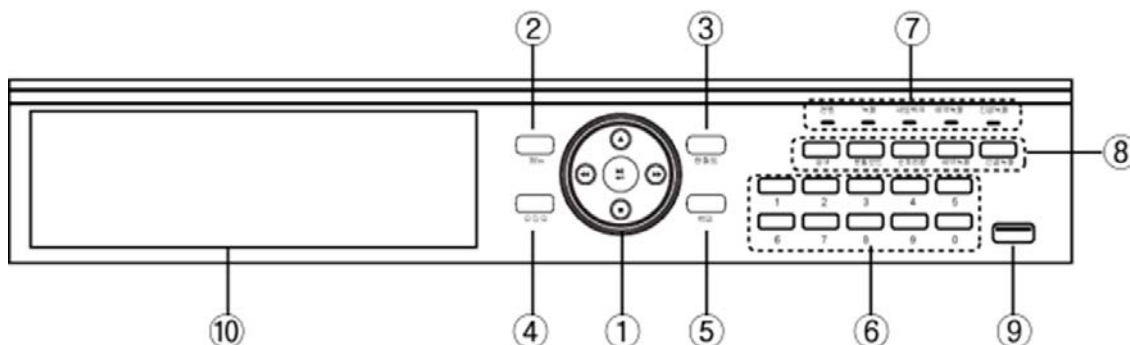

(Front Panel Image)

No	Button/Function	Description	
1	Direction Button / Playback Button	Use as a control button on Setup menu	
		Speed control on playback, Stop button, Pause button.	
2	Menu	Display a menu, Move to upper menu, Cancel a function	
3	Pan/Tilt	Display Pan/Tilt menu	
4	Audio	Display Audio listening menu	
5	Backup	Display Backup function of video data	
6	Number	Channel selection or number input	
7	LED Status	Show status of Power, Recording, Remote Access, Schedule Recording and Emergency Recording	
8	Function Button	Search	Display search menu
		Split Mode	Select split mode
		Sequence	Automatic screen shift
		Schedule Recording	Schedule recording
		Emergency Recording	Emergency Recording
9	Front USB Port	USB Connecting slot	
10	ODD	Available to connect ODD	

1-3. Rear Panel

It doesn't need special tool for DVR installation.

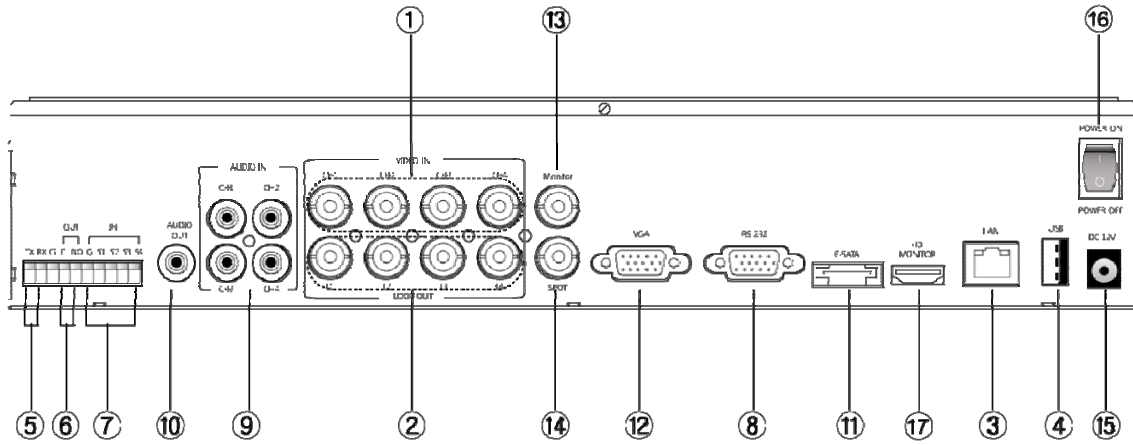

(4Ch rear panel)

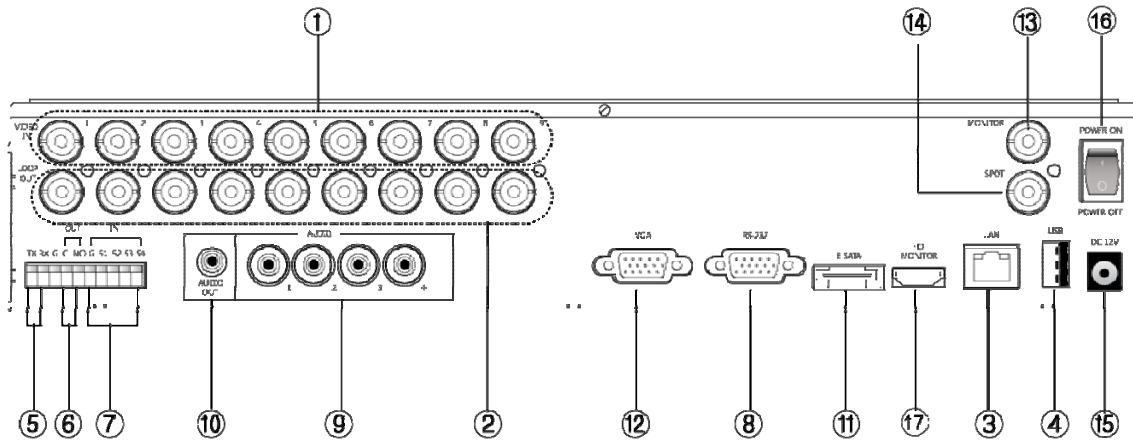

(9Ch rear panel)

DIGITAL VIDEO RECORDER MANUAL

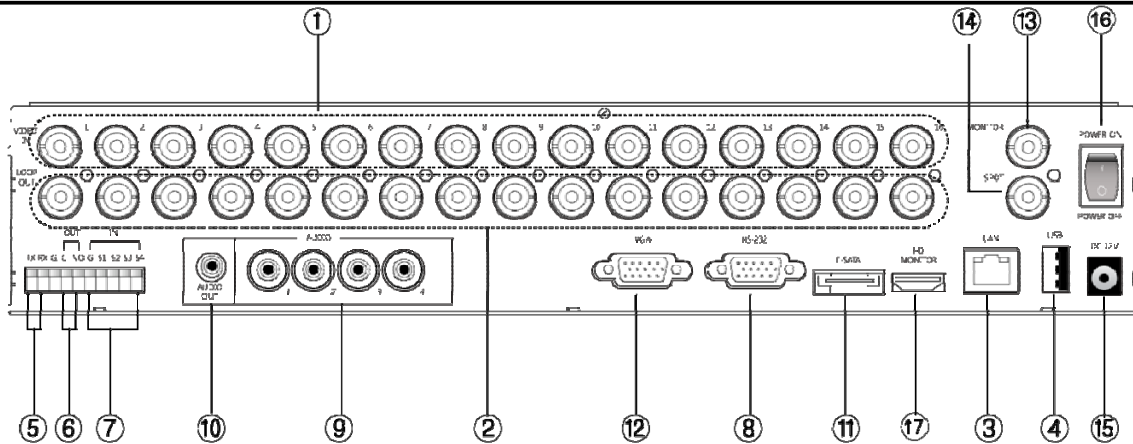

(16Ch rear panel)

- [1] VIDEO INPUT [2] VIDEO Loop Through [3] RJ-45 [4] USB (REAR)
 [5] RS-485 [6] ALARM OUT [7] SENSOR INPUT [8] SERIAL PORT [9] AUDIO INPUT
 [10] AUDIO OUT [11] E-SATA INPUT [12] VGA OUT [13] COMPOSITE MONITOR OUT
 [14] SPOT OUT [15] ADAPTOR JACK [16] POWER SWITCH [17] HDMI

1-4. Remote Controller

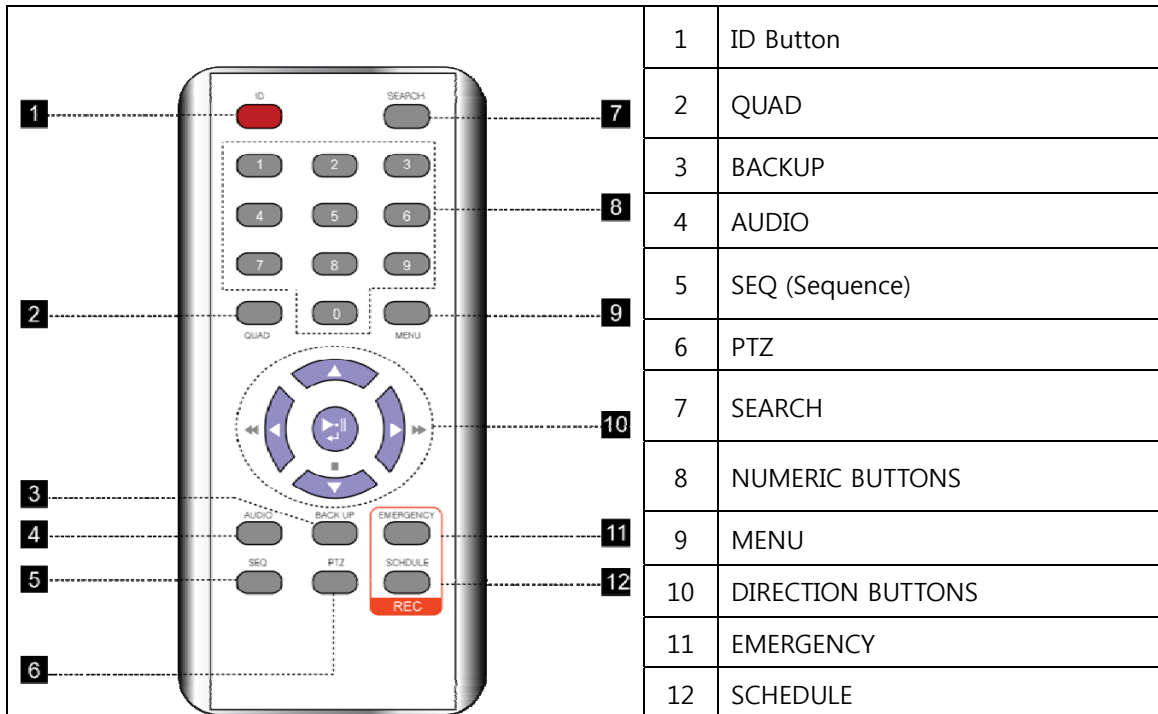

[Video Input]

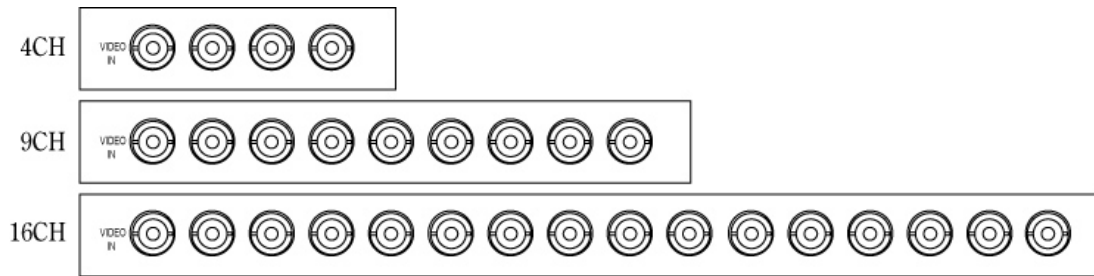

Connect it through COEX cable from Video source to VEDEO input.

[Loop through Video out]

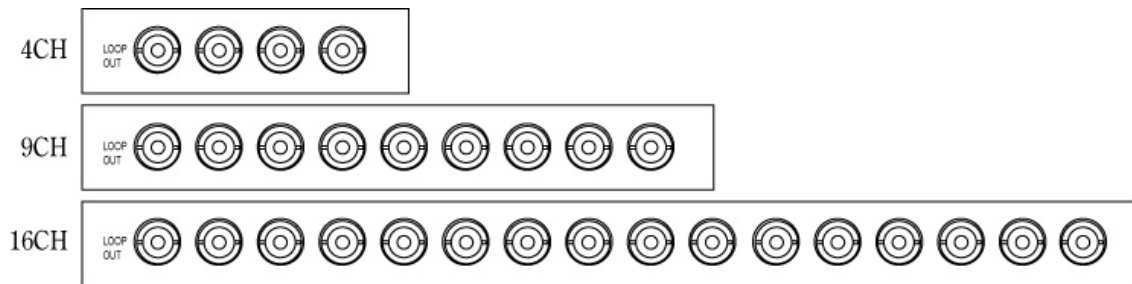

[VGA Out]

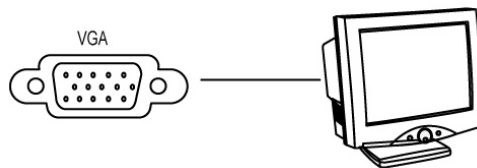

It is for VGA monitor usage.

[RS-485 connection (PTZ camera)]

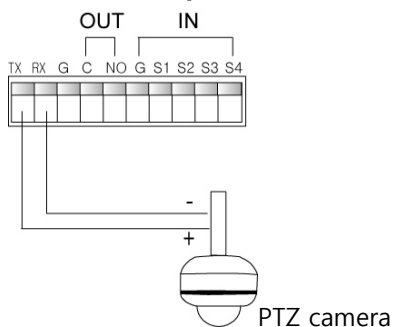

Connect the PTZ as per above diagram.

[RS-485 connection (External keyboard connection)]

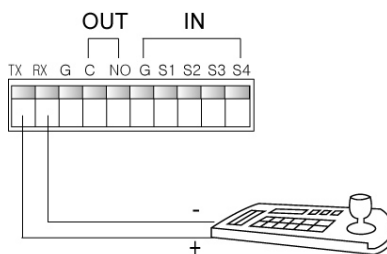

Please refer to the keyboard manual.

[Alarm Out connection]

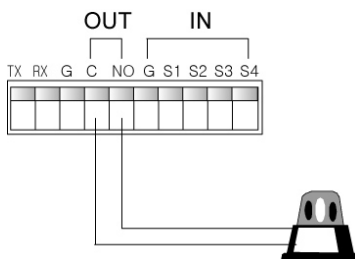

It supports 1 alarm out. Connect it as above.

【Sensor Input connection】

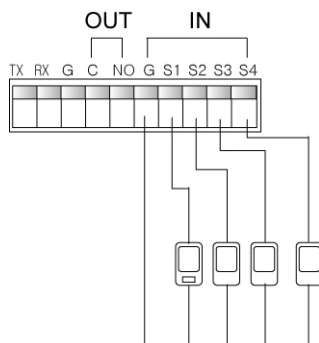

It supports 4 sensor input. Connect it as above.

【RJ-45 Port(Internet connection)】

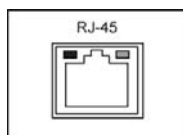

This DVR can connect to the N/W through 10/100/1000Mb Ethernet connector. Through the N/W, DVR can be made remote viewing, searching and control.

【USB Port】

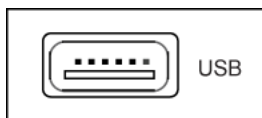

There are 2 USB port. One in front and the other is in rear. It is for F/W upgrade, Backup and mouse connection.

【HDMI Port】

HD
MONITOR

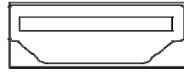

It is for connection with HDMI supporting monitor.

【E-SATA 】

E-SATA

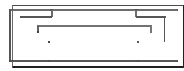

It is for the external HDD connection. It needs E-SATA cable for connection.

■ Chapter 2. Basic Information ■

2-1. Menu Display

It's available to make setup with menu button on front panel, a mouse and a remote

- ☞ Display Setup Menu with a front panel button
There are 'Menu' button on the front of unit. Press it to display Menu.
- ☞ Display Setup Menu with a remote
Press Menu button on a remote.
- ☞ Display Setup Menu with a mouse
Mouse right click to display pop-up menu. Select the menu you want to do setup.

2-2. Description of Icon

[1] The icons on the live screen indicate the status.



Recording



Video Loss



Motion Detection



Sensor

[2] Camera title will be shown as above.





[3] Status Bar

1. Display date and time
2. ER means Emergency Recording and SR means Schedule Recording.
3. Show network status and key lock
4. Show HDD status and display "Overwrite" when overwriting previous data.

2-3. Remote Controller

It is available to control every function with a remote. Controlling several DVRs with a remote is available..

DIGITAL VIDEO RECORDER MANUAL

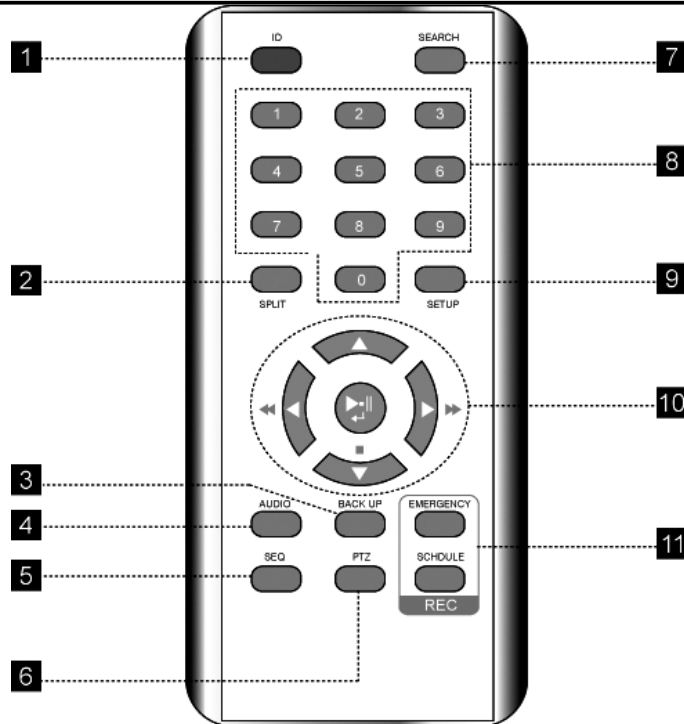

[1] ID : Press to select a remote controller ID in case of using one remote controller to multi DVRs.

[2] SPLIT : Press to see split mode. Once press. Same button with Quad button

[3] BACK UP : Press to start recorded data archiving to external media

[4] AUDIO : Select a audio channel

[5] SEQ : Press to display each camera in sequence for specific duration.

[6] PTZ : PTZ control menu...

[7] SEARCH : Call search menu to playback recording image.

[8] NUMBER BUTTON : Input the channel number to make full screen mode or the number in setup menu.

[9] SET UP : Press to display setup menu.

[10] DIRECTION KEY / CONFIRM BUTTON / PLAYBACK CONTROL

[11] Record Button

- EMERGENCY : Emergency Recording Button
- SCHEDULE : Schedule Recording Button

2-4. How to set remote controller ID

In order to use remote controller, the ID must be same both DVR and remote controller. By assigning DVR ID, it allows the user to control multiple DVRs with one remote controller.

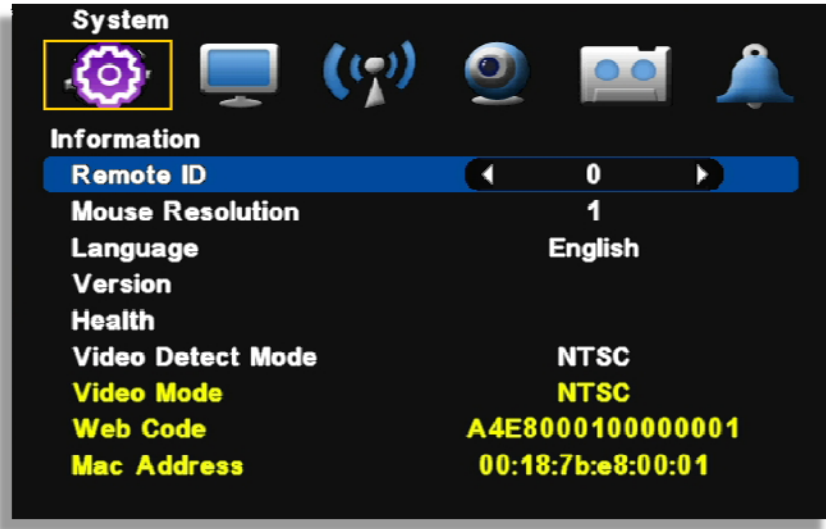

[1] Check current system ID and can be changed by user. (Factory default ID: "0")

Menu > System > Information > Remote ID (Range: 0 ~ 99)

System ID must be configured on DVR system menu. It cannot change DVR system on remote controller.

[2] How to use remote controller

ID must be identified between remote controller and system. Otherwise remote controller doesn't recognize DVR correctly.



Remote controller ID menu displays as above image when you press ID button of remote controller.

- DVR ID : It displays current ID of the system.
- "0" : Input the same ID number of DVR and press "Confirm"











2-5. How to display menu

It is available to display menu with front panel buttons, remote and mouse.

[1] Front panel button : Push "MENU" button on the front panel.

[2] Mouse : Right-click

[3] Remote : Push "MENU" button

 System	Go to main menu
 Search	Go to search menu
 Backup	Go to backup menu
 Audio Out	Go to audio output menu
 Emergency	Start emergency recording
 Schedule	Start schedule recording
 PTZ Control	Go to PTZ Control menu
 Sequence	Start sequence
 I/O	Switch output to Alarm or internal buzzer
 Split Mode	Change display split mode
 Zoom	Magnify the image at live or playback

2-6. Zoom in/Out

Magnify the image at live or playback.

[1] How to magnify with a mouse

Locate the mouse pointer on the place you want to magnify. And click the left button of mouse and drag it. You can cancel by dragging with mouse left button clicked. (Also you may use "Zoom In / Zoom Out" menu by displaying menu)

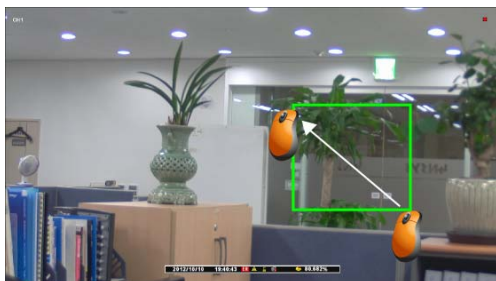

[2] How to magnify with a remote (Front panel button)

- On Live : Display Menu and select "Zoom In/ Zoom Out". And move with direction buttons. Select Menu button to cancel
- On playback : Select "Emergency Recording" and move with direction buttons. Select Menu" to cancel.

Chapter 3. System Configuration

3-1. Information

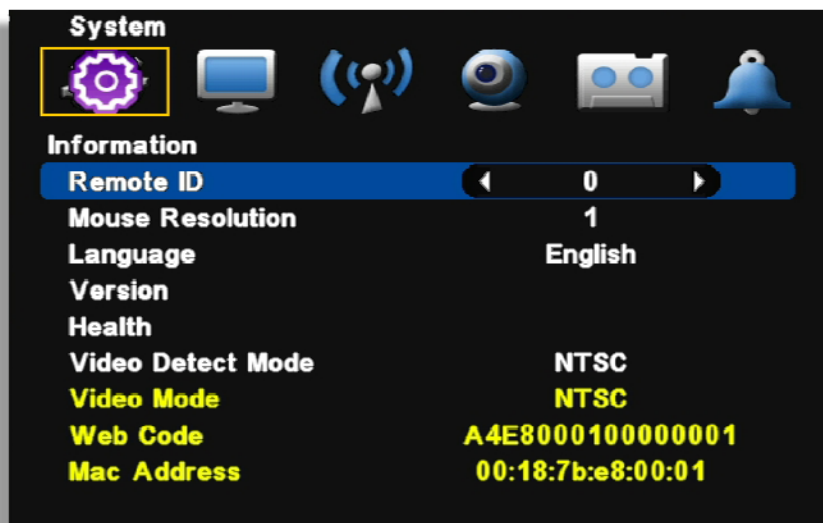

DIGITAL VIDEO RECORDER MANUAL

- [1] Remote ID : Assign the ID of remote controller, so that user can separately control multiple DVR unit with one controller. (ID range: 0 ~ 99)
- [2] Mouse Resolution : Mouse sensitivity level can be adjusted at user's convenience.
(Basic Level 1; Slow speed, Level 1 < Level 2 < Level 3 to increase reaction speed.)
- [3] Language : Select a language
- [4] Version : Show S/W, H/W and N/W
- [5] Health : Indicates storage status
- Hard Disk 1~2 : Display the temperature of hard disk
 - E-SATA : Display the temperature of hard disk connected to E-SATA
 - Board : Display the temperature of the DVR's main board.
- [6] Video Detect Mode : Select a video signal format. (NTSC / PAL)
- [7] Video Mode : Display video signal format
- [8] WEB Code : DDNS ID for DDNS connection.
- [9] MAC Address

3-2. Time/Date

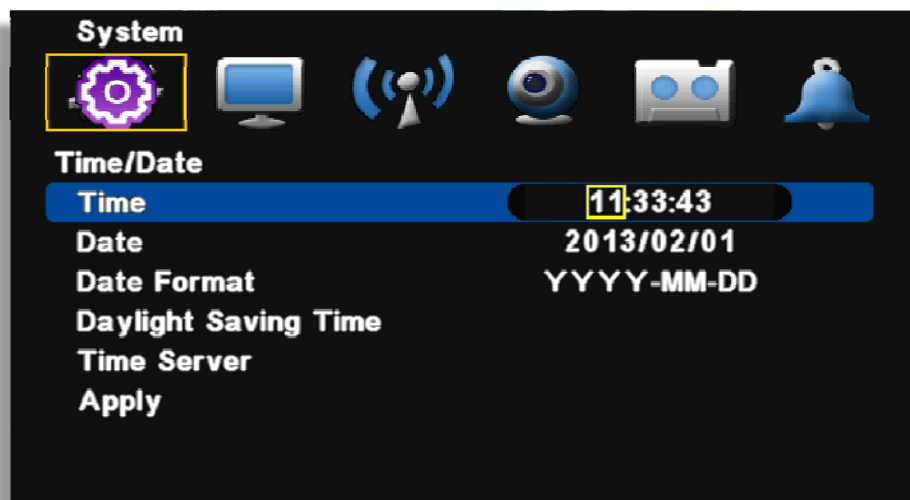

- [1] Time : Set time
- [2] Date : Set date
- [3] Date format : Select a Time/Date display format.
- [4] Daylight Saving Time : Set "ON" to apply daylight saving time.

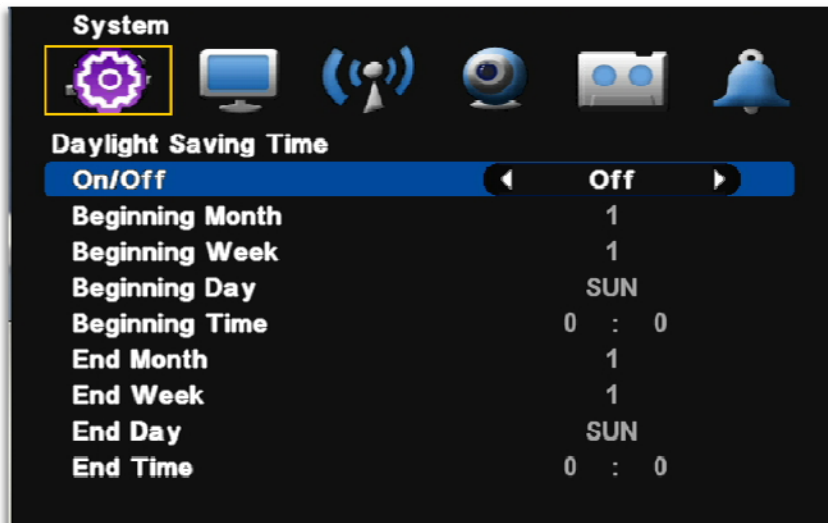

Enter Month/Week/Day to begin and also enter Month/Week/Day to end.

- [5] Time Server : Set time automatically through internet.

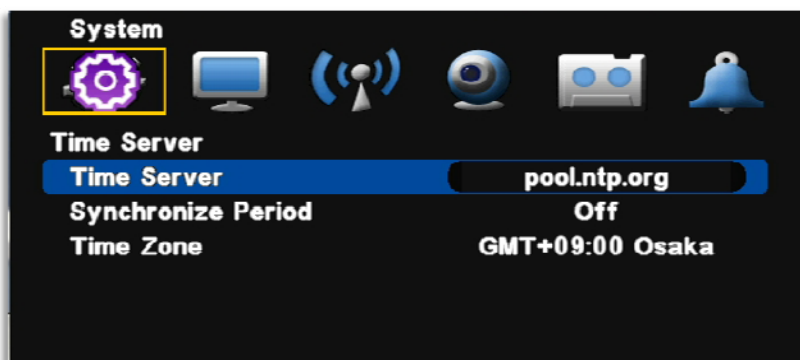

- Time server : Input the URL of server (Default : kr.pool.ntp.org)
- Synchronize Period : Select the period to synchronize between DVR and time server
 - Power On : Try to sync once power on.
 - 12Hour : Try to sync every 12 hours.
 - 24Hour : Try to sync every 24 hours.
 - Time Zone : Select Standard time

- [6] Apply : Save and apply time / date setting.

3-3. Password



[1] ID : Available to register max 8 account("Admin" and "User1~7)

- admin : Administrator ID
- User1~7 : User ID

[Note] Default password of all ID is "11111111".

[2] Assign an authority per selected ID

- Configuration : Available to set configuration
- Hard Disk : Available to set Hard Disk
- Search : Available to search
- Backup : Available to back up
- PTZ Setting : PTZ operation is available
- PTZ OSD Menu : Assign an authority to display PTZ OSD menu
- Record Key : Assign an authority to use "REC" on the front
- Camera : Available to see the selected channel

3-4. Hard Disk

As it is related to recording, if any setting is wrong, system error or abnormal recording could happen.

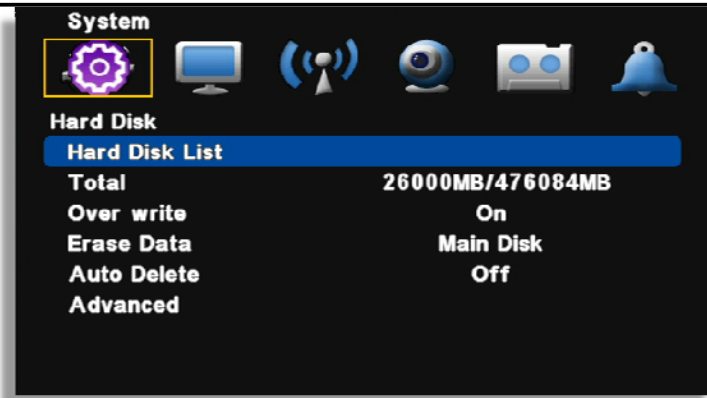

[1] Hard Disk List : It provides the information for Hard Disk, external USB Hard Disk and format.

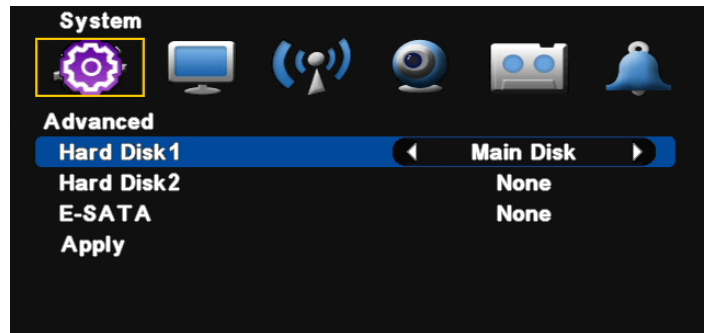

- Hard Disk 1~2 : Display the Hard disk capacity internally mounted
- E-SATA : Display the capacity of E-SATA
- Delete : Select a disk and format(delete) it

[2] Total : Display total capacity and used capacity of Hard Disk

[3] Over write : Record continuously by overwriting the hard disk

[4] Erase Data : Format several hard disks altogether.

- Main Disk : Format all the mounted disks named "Main disk"
- Mirror Disk : Format all the mounted disks named "Mirror Disk"

[5] Auto Delete : Keep the recorded data for the selected period and automatically delete the previous data.

[6] Advanced : Select whether a Hard Disk is used as Main disk or Mirror disk.

- Hard Disk 1~3 : Select with which purpose it will be used.
- E-SATA : Select with which purpose it will be used.
- Apply : Save the setting

[Note] After setting, select "Apply" to save. Then, the system is rebooted.

3-5. Default Setup

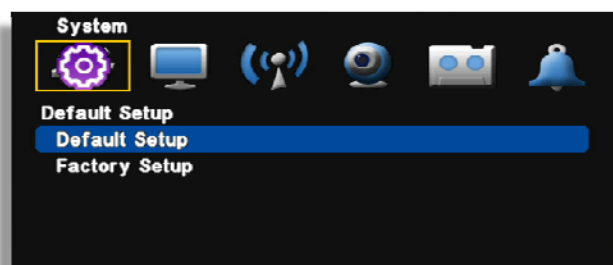

[1] Default Setup : Except major configuration (Network, Password), parameters are initialized.

[2] Factory Setup : All parameters are initialized.

3-6. Upgrade

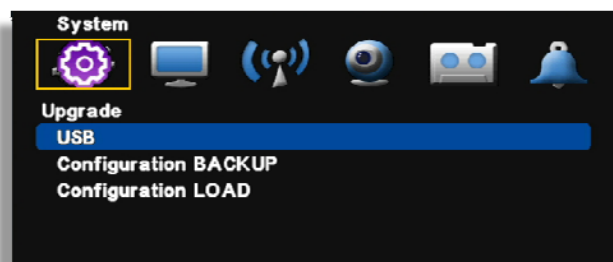

[1] USB (Firmware Upgrade) : In order to upgrade system firmware with USB memory stick, the firmware file must be saved in the USB storage first and then insert to DVR to start USB upgrade from the menu.

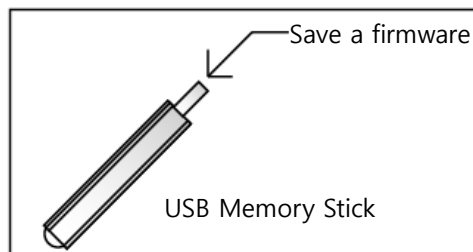

[Note]

Do not turn off power or remove USB stick while the upgrade is in progress.

[2] Configuration Backup : Save a configuration file of DVR.

[3] Configuration Load : Upload a configuration file to DVR.

3-7. Button Setup

After a certain time passes, screen is automatically locked.

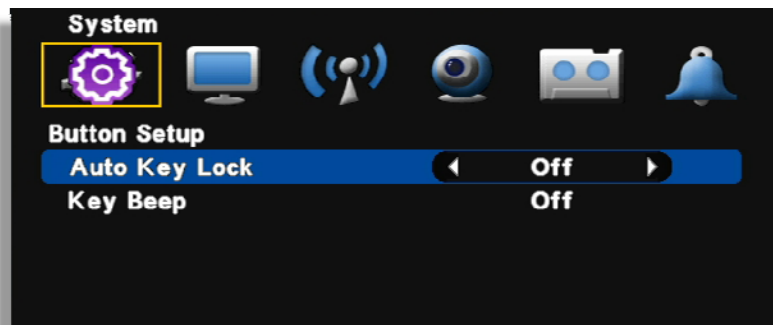

- Auto key lock : There is no key input during specific time, system locks the button automatically.
In order to unlock, input the password. (10 sec. 30 sec. 1 min. OFF)
- Key Beep : If you select ON, beep sound occurs

3-8. RS-485

In order to control the PTZ camera or control keyboard, DVR supports RS-485 port.

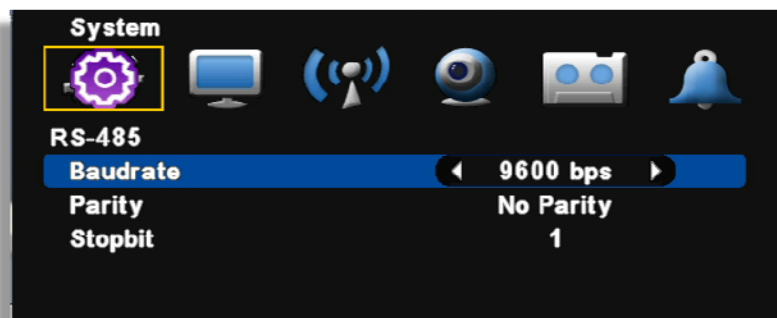

Baudrate /Parity /Stopbit : Refer to the manual of "Keyboard" or "PTZ camera"

Chapter 4. Display

4-1. OSD (On Screen Display)

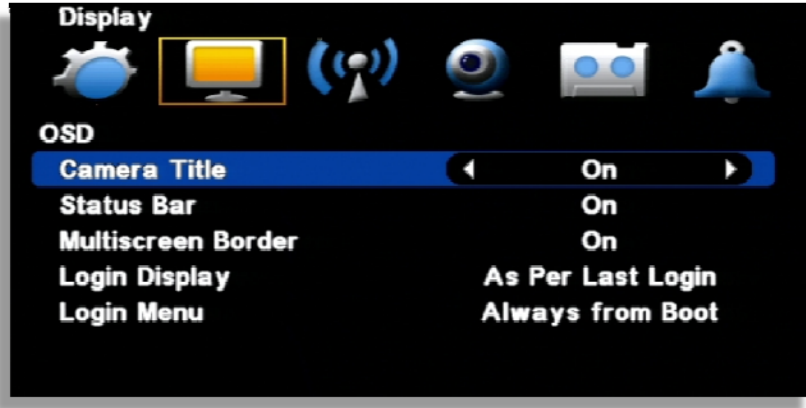

[1] Camera Title : ON / OFF

[2] Status Bar : ON / OFF.

[3] Multiscreen Border : ON / OFF.

[4] Login Display : Select a login option

- As Per Last Login : Display live image after system rebooting.
- Cover All Camera : Do not display live image after system rebooting.

[5] Login menu : Select a log in option.

- Always from boot : Input the password after rebooting.
- Boot after lock : Auto login after rebooting.

4-2. Split Mode

DVR provides the various of split mode when you press the "QUAD" button. You can choose the split mode and change the channel. Multi split mode is subject to each model.

[Note] If you press the "UP" key in live mode, the split mode is changed and if you press "RIGHT (direction)" key, the split group is changed.

Select the split mode

16 Split mode (For 16Ch Model)

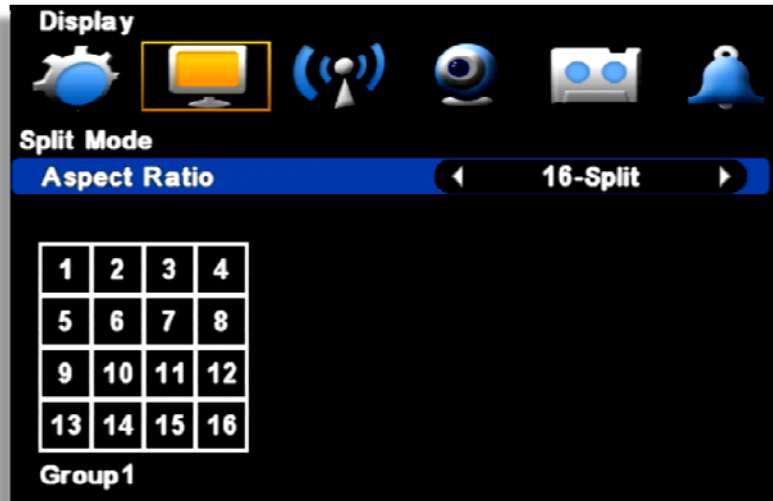

- Default 16 split mode.
- Select 16 split mode then press "QUAD" button to setup 16 split mode.

13 Split mode (For 16Ch Model)



- 13 split mode provides 2 different group of display.
- Select 13 split mode and press "QUAD" button to display 13 split mode on the screen. Press "Right" direction button to select the group 1 or group2.
- If you want to change the Ch number, click or using the scroll wheel of mouse)

9 Split mode (For 9/16Ch Model)

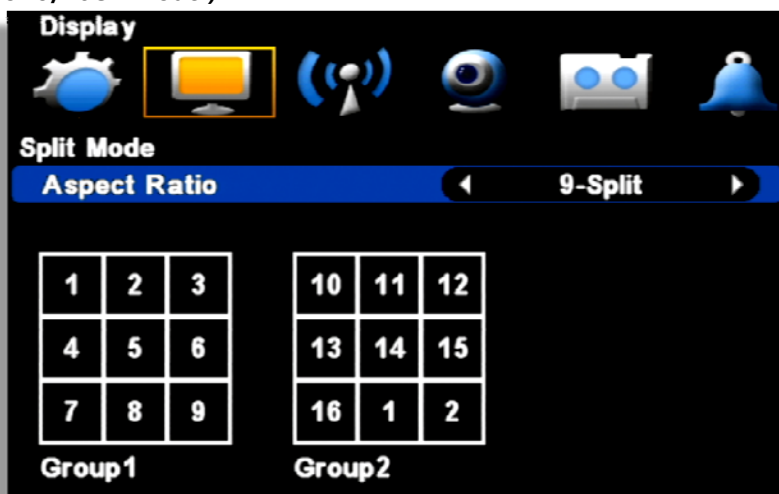

- 9 split mode provides 2 different group of display.
- Select 9 split mode and press "QUAD" button to display 9 split mode on the screen. Press "Right" direction button to select the group 1 or group2.
- If you want to change the Ch number, click or using the scroll wheel of mouse

6 Split mode (For 9/16Ch Model)



- 6 split mode provides 3 different group of display.
- Select 4 split mode and press "QUAD" button to display 4 split mode on the screen. Press "Right" direction button to select the group 1, group2 or group.
- you want to change the Ch number, click or using the scroll wheel of mouse.

4 Split mode (For 4/9/16Ch Model)



- 4 split mode provides 4 different group of display.
- Select 4 split mode and press "QUAD" button to display 4 split mode on the screen. Press "Right" direction button to select the group 1, group2, group 3 or group 4.
- If you want to change the Ch number, click or using the scroll wheel of mouse.

4-3. Auto sequence

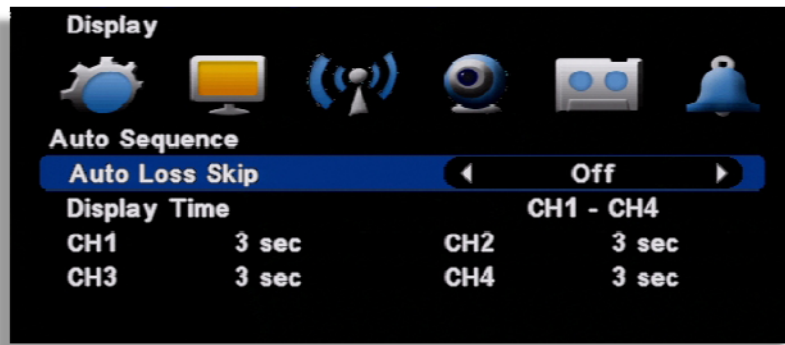

- Auto Loss Skip : If there is no video input, it skip video loss channel.
- Display time : Select a display duration while sequencing (1 sec. ~30 sec.)

[Note] Sequence doesn't work on event pop-up.

4-4. TV Adjustment

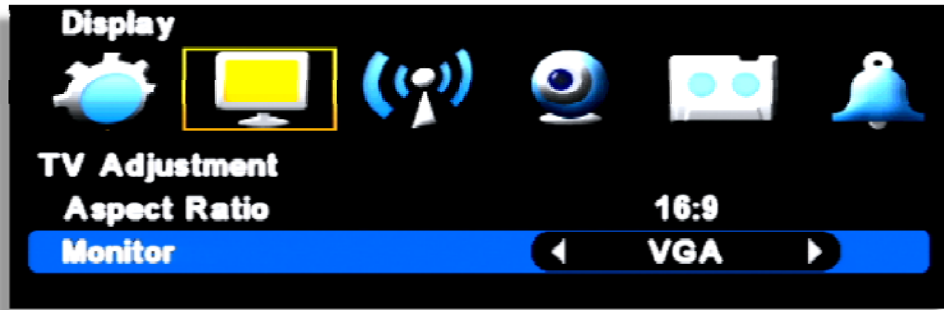

[1] Aspect Ratio : Output is selectable between 4:3 and 16:9 ratio.

[2] Monitor : Change the icon position.

- Small : When using small monitor.
- NORMAL : When using normal monitor
- VGA : When using the monitor for VGA

4-5. Spot Out

Control extra spot output on rear panel. By using additional monitor, event triggered video display and sequence display are available.

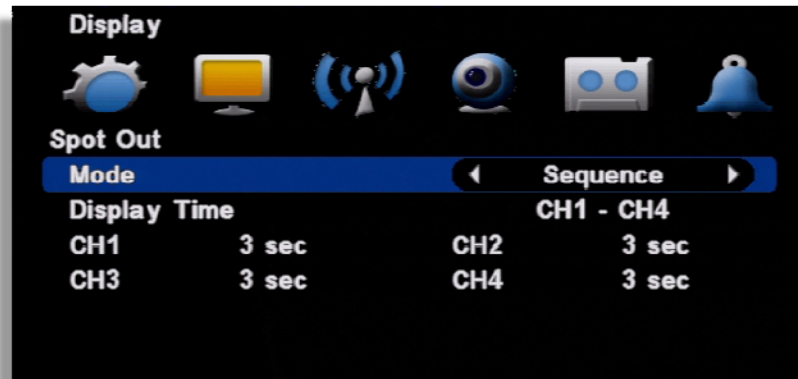

[1] Mode

- Sequence : Display videos in selected time order per channel.
- Event : Display event triggered channel.
- Seq+Event : If an event is triggered, the video is displayed first and then videos displays in sequence.

[2] Display Time : Set time per channel applied in sequence display.

Chapter 5. Network Setup

5-1. IP Address

It is the system setup for remote monitoring or backup and it needs the network setup of DVR.

The user must know whether their internet is dynamic IP(DHCP) or fixed IP. Please check it to your ISP before setup.



[1] DHCP : "ON" for dynamic IP user.
"OFF" for static IP user.

[2] IP Address : Input the IP address.

[Example]

- IP address : 61.250.152.050
- Subnet Mask : 255.255.255.000
- Gateway : 61.250.152.001
- DNS Address : 164.124.101.002

[3] DDNS Address : Do not change the DDNS server IP (61.250.157.15)

[4] Use Port : Default port is 3000.

[5] Upnp : If a router supports Upnp, it automatically set port forwarding.

[NOTE] In case of using the router, the user should make port forwarding.

The port forwarding function is described on the router manual.

5-2. Notification

E-Mail Setup

It's a basic setup to send E-mail, so if it is not correct, e-mail couldn't be delivered. So be careful to make Setup correctly.

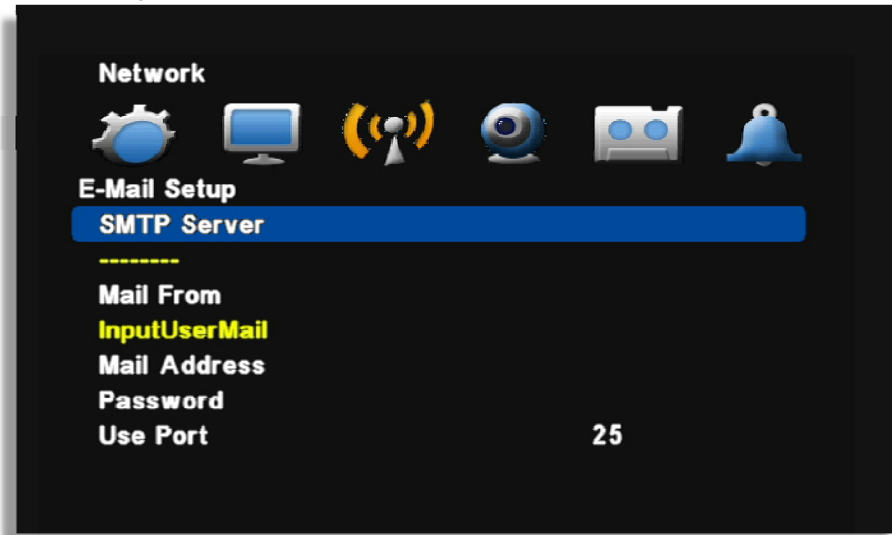

[1] SMTP Server : Enter Mail Server address to use as SMTP Server. If you don't know the Server address, contact a person who manages SMTP Server you use.

[2] Mail From : Enter the mail address which you use. (It is for preventing a mail blocked as spam.)

[3] Mail Address : Enter recipient's mail address (Available up to 3 account)

[4] Password : Select if ID/Password input is necessary when sending a mail.

[5] Use Port : Most of Mail Servers use 25 for port. Check Port if system doesn't work after setting.

5-3. E-mail Notification

Select which type of notifications you are going to use.

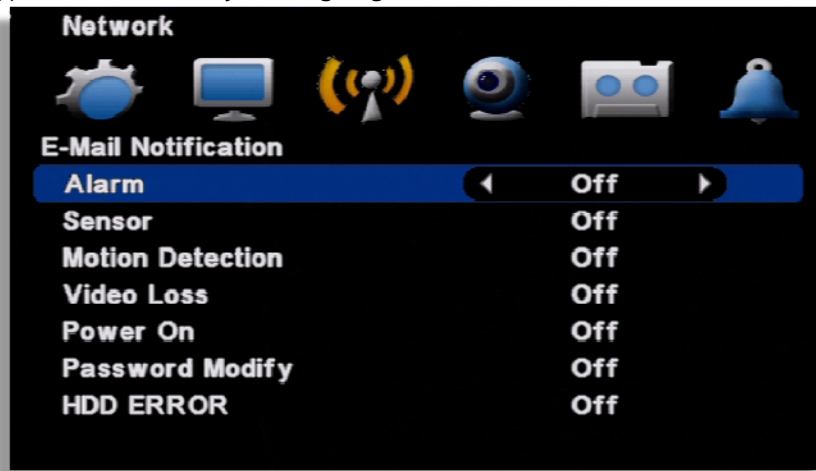

Notification type : You can select the type for E-mail notification.

- Alarm : E-mail is sent with still image when an alarm occurs
- Sensor : E-mail is sent with still image when triggering a sensor
- Motion Detection : E-mail is sent with still image when detecting a motion.
- Video Loss : E-mail is sent when video input is lost.
- Power On : E-mail is sent when power is on after off.
- Password Modify : E-mail is sent when the system password is modified
- HDD Error : E-mail is sent when HDD error happens

5-4. Web Server

Built-in web server make user can connect the DVR remotely on the Internet Explorer

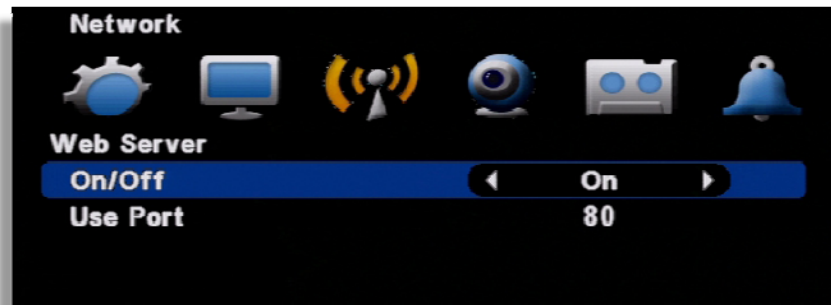

[1] ON/OFF : Select 'ON' to use remote N/W connection through web.

[2] USE PORT : Port for remote connection

5-5. Free DDNS

Free DDNS is used for remote connection through private DDNS service.

Firstly, go to <http://www.dyndns.com> and create an account. Then, if your system is installed with a router, you must make DMZ setting in the router setup for the IP your system has.

DMZ is a function to open all the ports for the selected IP.

Input registered information in DVR setup.

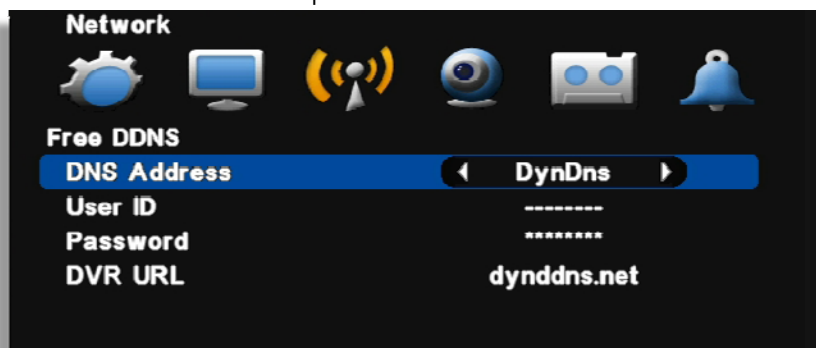

- DDNS address : Select the private DNS service name (Select DyDns)
- User name/ Password/ DVR Address : After creating an account in the relevant website, input the ID/ Password/ URL information allocated to DVR setup.

5-6. Dual Codec Setup

It is available to transmit data through extra network transmission codec. There are two ways of setting. Split Resolution is a transmission mode for split screen and Popup Resolution is a transmission mode for one channel full screen.

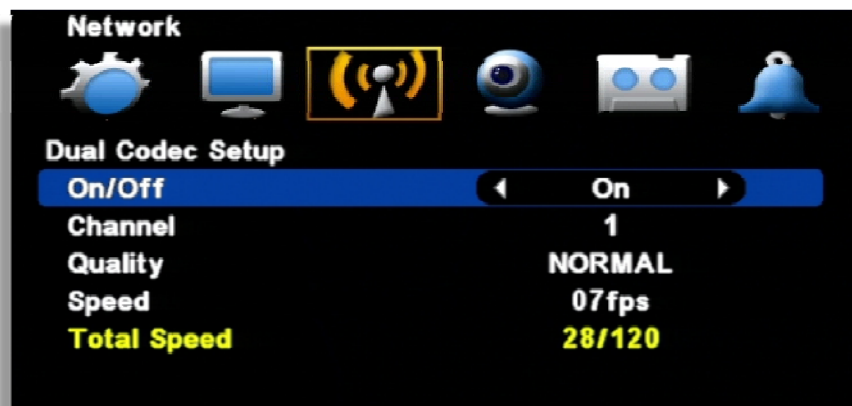

- On/Off : Select "On" to use dual codec setup
- Channel : Select channel to set (Available to set per channel)
- Speed : Select transmission frame of split screen

Chapter 6. Camera

6-1. Camera Setting

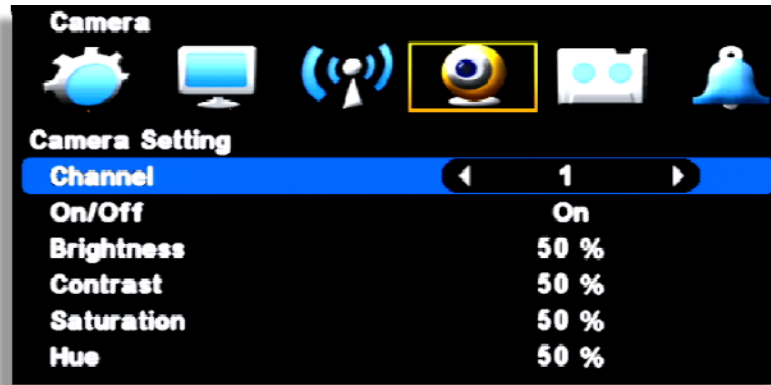

- Channel: It is for channel selection.
- On/Off/Covert: It is for camera usage.
 - On: Use
 - Off: Not use
 - Covert: It doesn't show the image
- Brightness: Bright control
- Contrast: Contrast control
- Saturation: Black/White control
- Hue: Magenta and Cyan control

6-2. Camera Title

Input a camera title using by virtual keyboard.



Press a space bar to change a language.

6-3. PTZ Setting

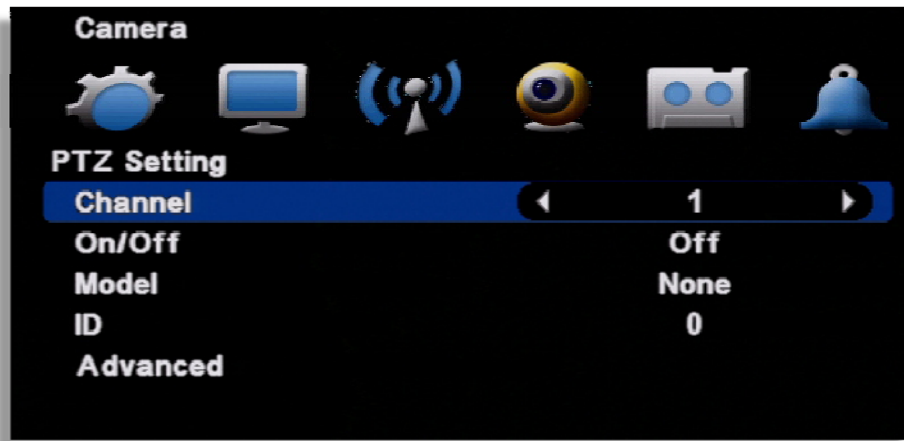

- [1] Channel: Select a channel
- [2] ON/OFF : Enable or disable to use PTZ.
- [3] MODEL : Select the PTZ protocol or, model
- [4] ID : Select the PTZ ID. (For more detail, refer to the manual of PTZ device.)

Advanced

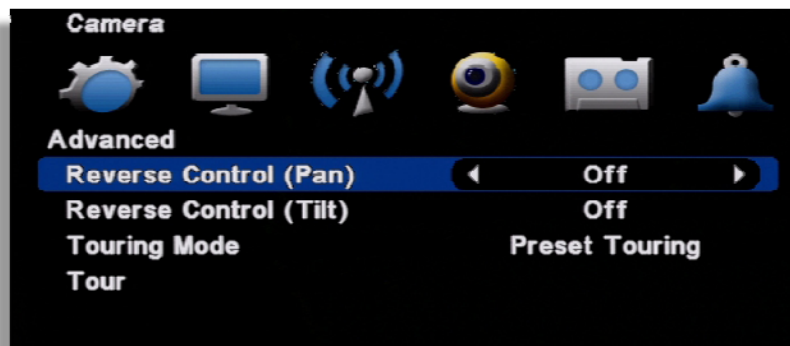

- [1] Reverse Control (Pan) : Set the Pan works reverse direction.
- [2] Reverse Control (Tilt) : Set the Tilt works reverse direction.
- [3] Touring Mode
 - Preset Touring : Use touring by DVR setting.
 - Camera Touring : Use touring by camera setting. (PTZ camera built-in touring function is available only.)
- [4] Setup Preset Touring
 - It is operable when you select the 'preset touring' from the touring mode' menu.

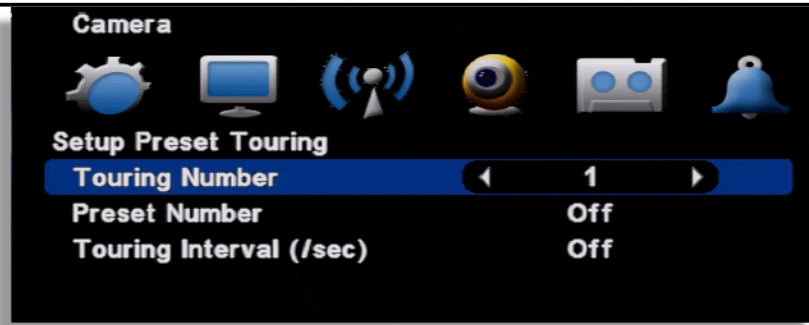

The touring number is selectable 1~16.

[1] Touring number : Select the number.

[2] Preset number : Select the preset number saved before.

[3] Touring interval (/SEC) : Select the touring dwell time.

[NOTE] PTZ protocol selection

Protocol is PTZ moving driver. The protocol is registered as per the camera model name or protocol name. Please check whether you PTZ is usable for this DVR. The touring is supporting when the camera itself support the touring function.

6-4. How to use PTZ

[How to call the PTZ menu]

- Mouse menu: Click the right button of mouse and select the 'PTZ'.
- Remote controller menu: Click the "PTZ" from remote controller.

(1) Select PTZ Button on the remote controller

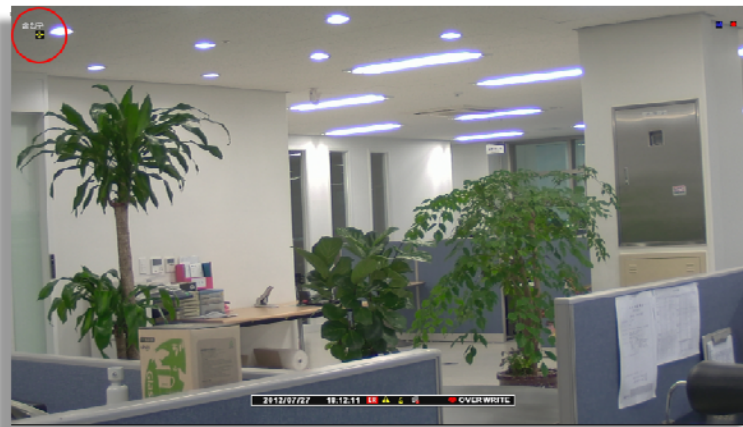

DIGITAL VIDEO RECORDER MANUAL

- When you select PTZ button, + shape icon appear. Then move to the channel you want by the direction key.

(2) If you moved to PTZ channel, then after pushing "SET UP" button, select the menu to operate.



- PanTilt : Control the direction by the direction key in remote controller.



- Preset : Input the preset number to be moved or saved and select this menu.

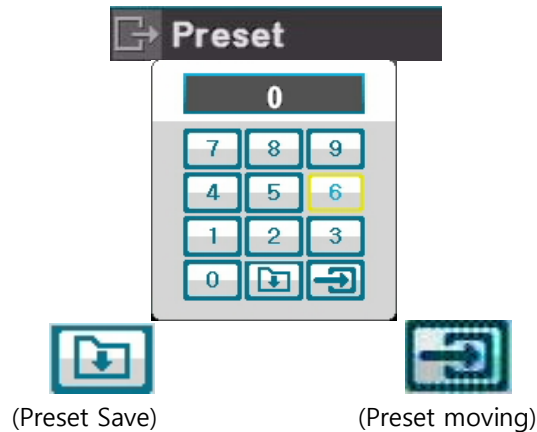

- Tour : It tours as per the saved preset number.

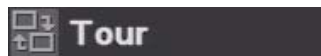

- MENU : It can recalls the PTZ camera OSD menu

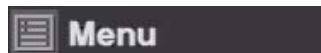

- Channel : Change channel at split screen. Available to move with direction button after selecting a channel. (Only work on split screen)



- Auto Focus : Adjust the focus automatically.



- Exit : Escaping the PTZ mode



Chapter 7. Record

7-1. Record Setting

Set resolution, quality, recording speed and audio. Each setting affects the size and picture quality.



- [1] Channel : Set channel
- [2] On/Off : Set On or Off for recording
- [3] Resolution : Set resolution
- [4] Quality : Set picture quality of recorded video
- [5] Speed : Set record frame

[6] Post-Recording : Set recording duration time after an event is triggered.

[7] Record Audio : Set On or Off for audio recording

[8] Total rec frame rate : It shows the occupied frame rate from possible total record frame.

7-2. Weekly Record

Set schedule record per day of the week, time and channel. And setting per hour is also available.

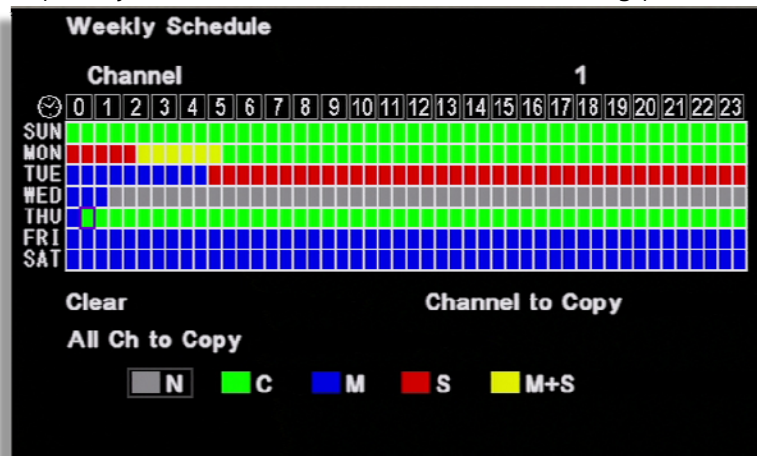

- N (Grey) : No record
- C (Green) : Continuous record
- M (Blue) : Motion detected record
- S (Red) : Sensor triggered record
- M+S (Yellow) : Recording by motion detection or sensor triggering

[How to setup]

- Select a channel
- After selecting the day of the week and time, every mouse click makes color shift like N(Grey) → C(Green) → M(Blue) → S(Red) → M+S(Yellow)
- After selecting the other day of the week and time, every OK button click makes color shift.
- Clear : Delete the schedule of the selected channel
- Channel Copy : Copy the currently set recording schedule to the selected channel.
- All Ch to Copy : Copy the currently set recording schedule to all channels.

7-3. Holiday Record

Set holiday record with different option.

[1] 7 different holiday setup can be made.

After selecting record type from H1 to H7, set time with mouse dragging or remote direction key.

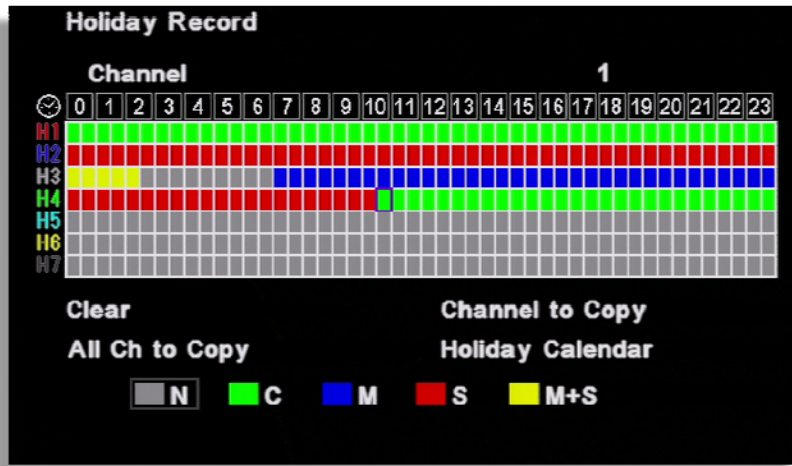

[2] Select the Holiday on Holiday Calendar and then set the holiday type among H1 to H7.

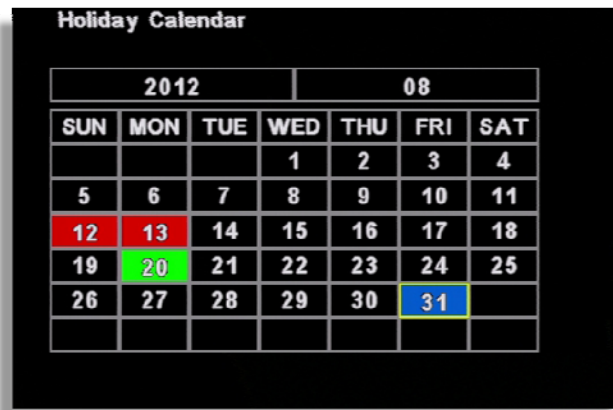

Every mouse click on the selected date makes color shift and available to set from H1 to H7.

Chapter 8. Event Setup

8-1. Sensor

It is for sensor setup.

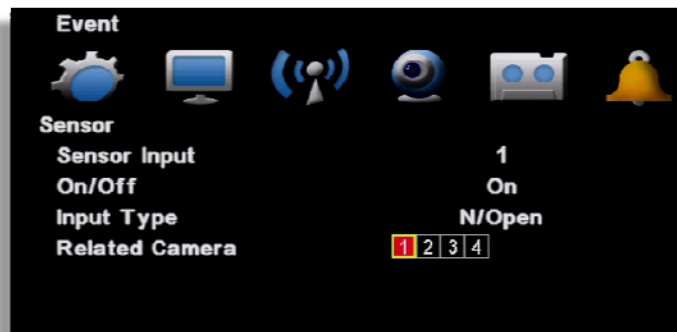

[1] Sensor Input : Select the sensor input channel.

[2] On/Off : Select the sensor usage.

[3] Input Type: Select the sensor input type.

- N/Open (NORMAL OPEN) : The contact is normally opened but close when the signal is generated.
- N/Close (NORMAL CLOSE) : The contact is normally closed but open when the signal is generated.

[4] Related camera: Select the camera to be related with sensor. Multi-selection is possible.

8-2. Motion Detection

It is the motion detection setup menu.

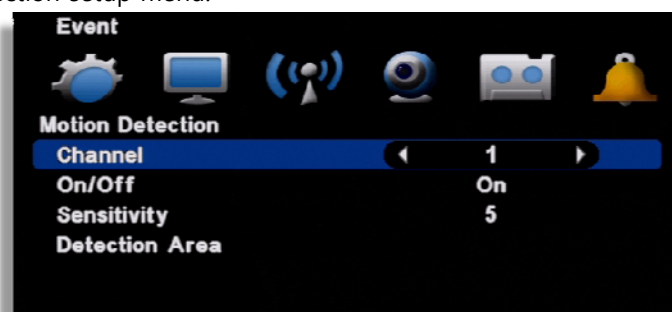

[1] Channel : Select the motion detection channel.

[2] On/Off : Select the motion detection usage.

[3] Sensitivity : Select the sensitivity of motion detection. Please apply it after the actual testing.

[4] Detection Area: Select the motion detection area. (1~5)



The cursor moving by the direction key and if press "enter", this block is designated for motion detection.

- MD selected area : Pink color
- MD non-selected area : Transparent
- If the movement is detected, the color of that area turns green.

[Apply to all] If you use the following key, you can apply or release in one button
"No1" button: Release all "No 2" button: Select all.

[Using mouse]

Locate the pointer on start point and click the right button then dragging to the ending point.

8-3. EVENT ACTION

Event record will be made as per the setup.

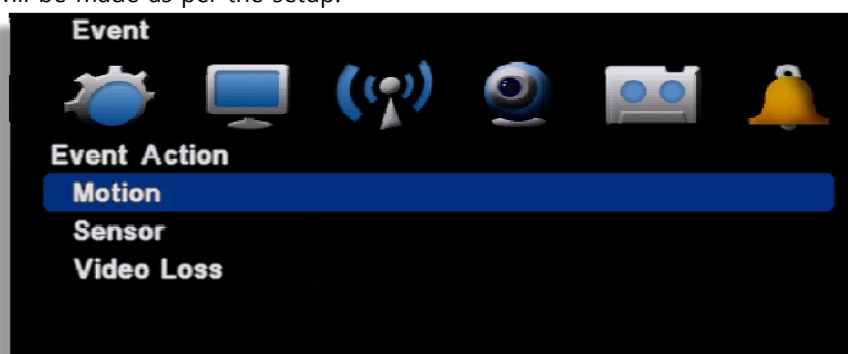

[1] Motion : It is the setup for PTZ, pop-up, relay out, buzzer in motion detection.

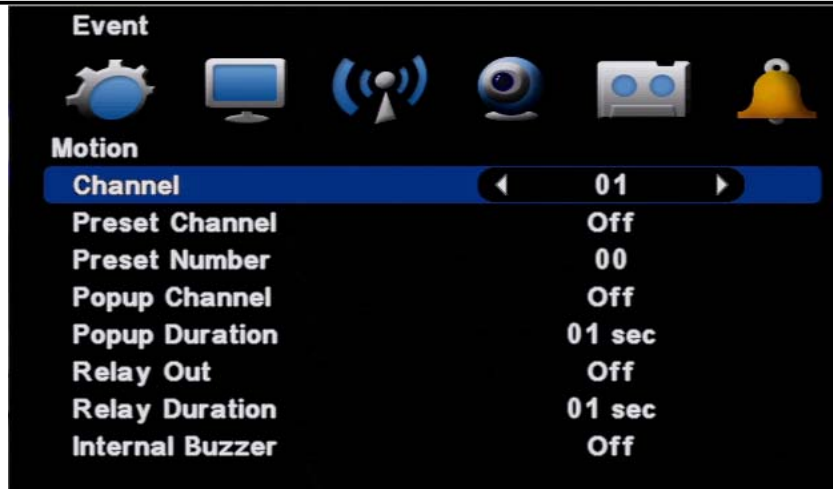

- Channel : Select the channel to apply.
- Preset channel : Select the preset camera being applied for the event.
- Preset number : Select the preset number to move.
- Popup Channel : Select the usage Popup usage by ON/OFF.
- Popup Duration : Popup window floating time.
- Relay out : Select the alarm out
- Relay duration : Relay out duration.
- Internal buzzer : Internal buzzer usage.

[2] Sensor : It is the setup for PTZ, pop-up, relay out, buzzer in sensor triggering.

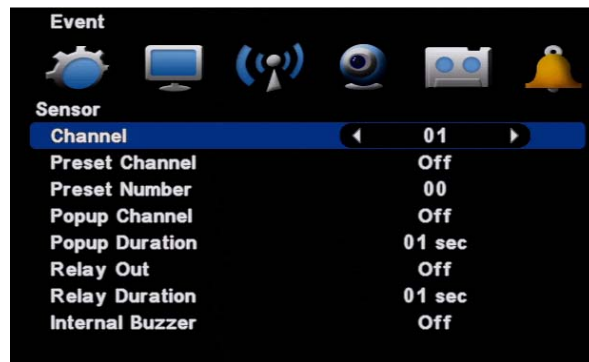

- Channel : Select the channel to apply.
- Preset channel : Select the preset camera being applied for the event.
- Preset number : Select the preset number to move.
- Popup Channel : Select the usage Popup usage by ON/OFF.
- Popup Duration : Popup window floating time.
- Relay out : Select the alarm out

- Relay duration : Relay out duration.
- Internal buzzer : Internal buzzer usage.

[3] Video loss : It is the setup for PTZ, pop-up, relay out, buzzer in video loss.

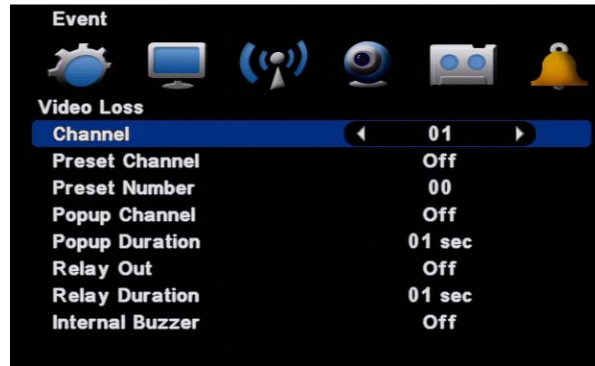

- Channel : Select the channel to apply.
- Preset channel : Select the preset camera being applied for the event.
- Preset number : Select the preset number to move.
- Popup Channel : Select the usage Popup usage by ON/OFF.
- Popup Duration : Popup window floating time.
- Relay out : Select the alarm out
- Relay duration : Relay out duration.
- Internal buzzer : Internal buzzer usage.

Chapter 9. Search

9-1. Search menu

It supports the various ways of search mode such as Calendar, Date/Time, Event, etc.

[1] How to call menu : Select the "SEARCH" from remote controller and right button of mouse.

[2] Search mode selection

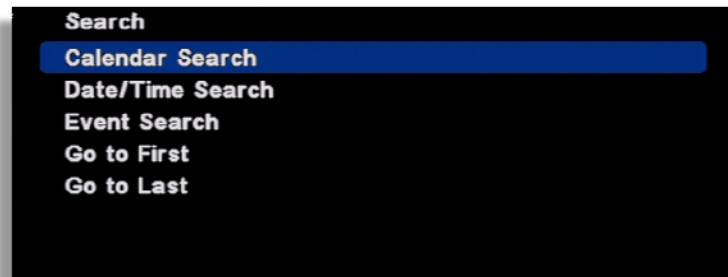

- Calendar search: It searches by calendar.
- Date /Time search: It searches specific Date/Time.
- Event search: It searches as per the event.
- Go to first : It searches the first recorded data on HDD.
- Go to last : It searches the last recorded data on HDD.

9-2. Calendar search

It searches using by the calendar.

- [1] If there is the recorded data on DVR, it shows red color on recorded date. Using the direction key, you can change the YEAR/MONTH/DATE.

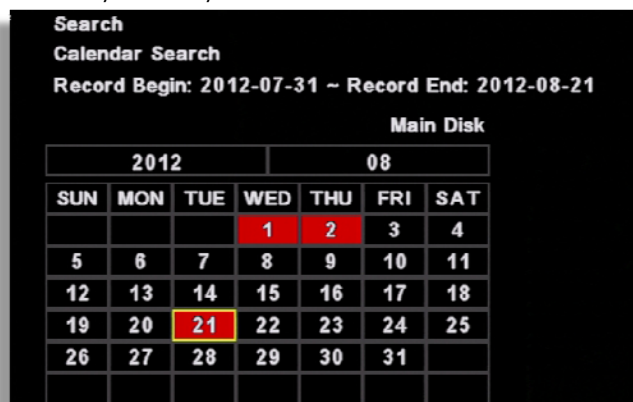

- [2] If there is the recorded data, it shows red color so, press the enter button on selected date.



(Channel display could be different per model 4ch/8ch/16ch)

- [3] The recorded data shows as a graph and select the minutes to search.

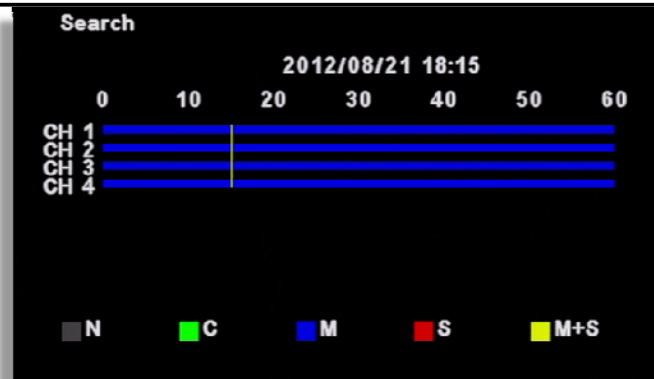

(Channel display could be different per model 4ch/8ch/16ch)

9-3. Date/Time search

If you know the specific date/ Time, input the time to search.

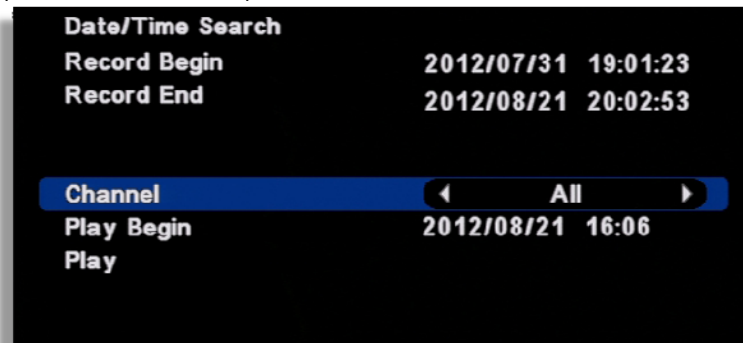

- [1] Record begin : It shows the record began time.
- [2] Record end : It shows the record end time.
- [3] Channel : Select the channel to search.
- [4] Play Begin : Input the time to search.
- [5] Play : If you click "Play", it playback the selected time.

9-4. Event search

It searches event recorded data.

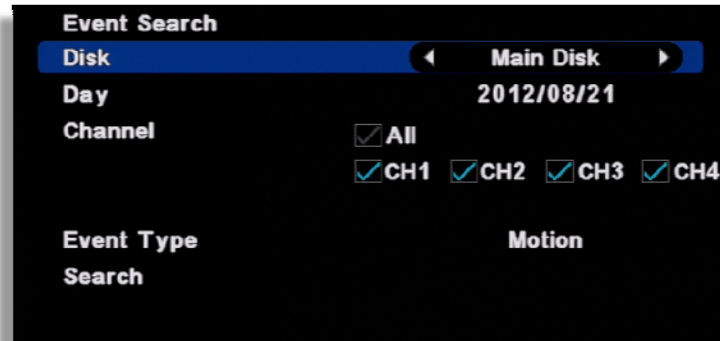

- [1] Record begin : It shows the record began time.
- [2] Record end : It shows the record end time.
- [3] Channel : Select the channel to search.
- [4] Play Begin : Input the time to search.



- [5] Play : If you click "Play", it playback the selected time.

9-5. Go to first / Go to last

It searches the first or last recorded image.

9-6. Search Control

[Control by mouse]

Description of search button

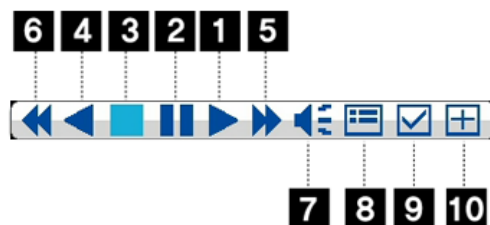

- [1] X1 playback
- [2] Pause
- [3] Stop
- [4] Reverse playback
- [5] Playback speed control
- [6] Reverse playback speed control
- [7] Audio during playback
- [8] Calendar search during playback
- [9] Mark In-Mark Out : If you click it during playback, it recognizes as a backup start time and if you click it once again, it recognizes as a backup end time. After this, it moves to the backup menu automatically.
- [10] Screen magnifying function in the full screen. (Use Emergency recording button on the remote controller.)

[Control by Remote control]

Use the direction from the remote control to control the speed

9-7. Audio

Audio can be listened in Live or Search.



[1] Menu recall : If you select the "AUDIO" during the live or playback, the audio out menu show up. The menu call is possible by remote controller or mouse.

[2] Mode selection

- OFF : No audio use.
- CH1 : Audio out only from CH1
- CH2 : Audio out only from CH2
- CH3 : Audio out only from CH3
- CH4 : Audio out only from CH4
- Auto : Only selected channel audio out.
- Volume control : If the length of bar increase, the volume louder.



Chapter 10. Backup

10-1. Backup

Selected image can be backup to the external device(USB). Connect the USB pen drive to the DVR and select 'BACKUP' button from remote controller or, click the right button of mouse.

[1] Select the recognized backup device. If it recognized normal, it shows the device capacity such as "XXX MB".

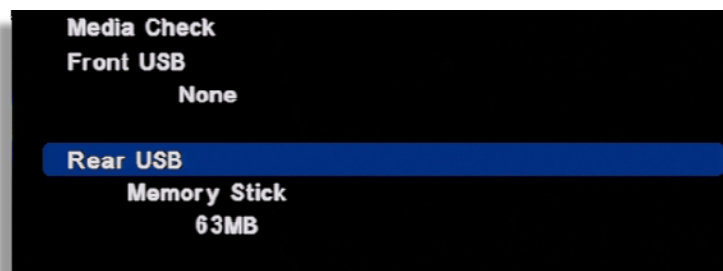

DIGITAL VIDEO RECORDER MANUAL

[2] Select the date from Calendar.

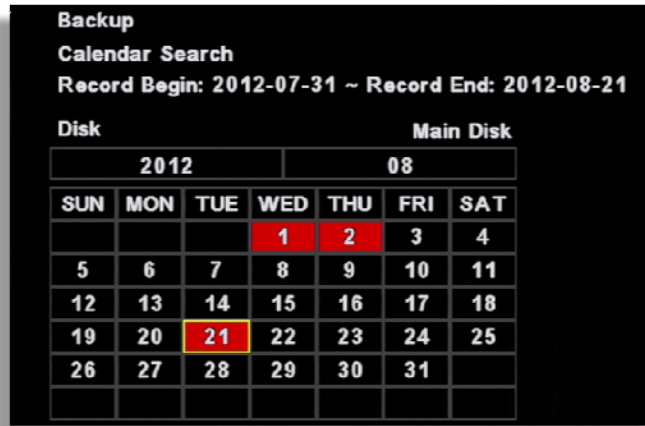

[3] Select the time by double click.

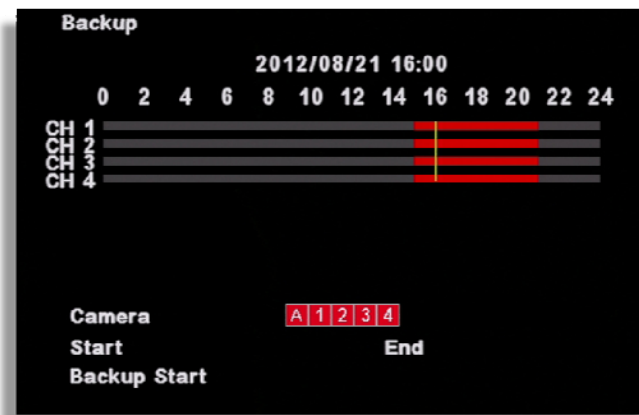

(Channel display could be different per model 4ch/8ch/16ch)

[4] Select the minute. Once you select "Start", the time will be automatically input.

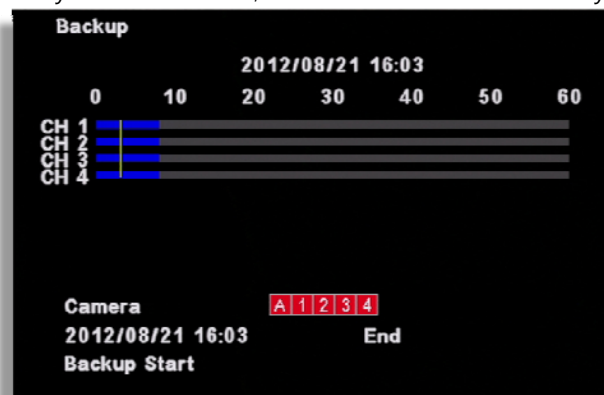

[5] Backup end time selection

- If the backup end time is the same hour, select the minute and click, "end", the time will be automatically input.
- If the backup end time is the different hour, go back to the previous menu by right button of mouse or, "MENU" button. Then, select the hour/minutes and click "end" for automatic time input.

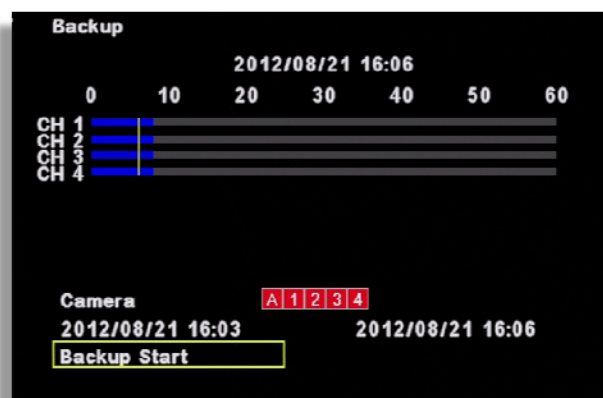

[6] Camera : Select the channel to be backup.(Selected channel will be shown as red)

[7] Backup Start : If all setup is completed, click the 'Backup start' button then, backup starts. It shows the backup capacity/ USB pen drive capacity" so, if everything is OK, click 'OK'.



DIGITAL VIDEO RECORDER MANUAL

[8] Before backup, it shows the USB port, backup time then, select OPTION.

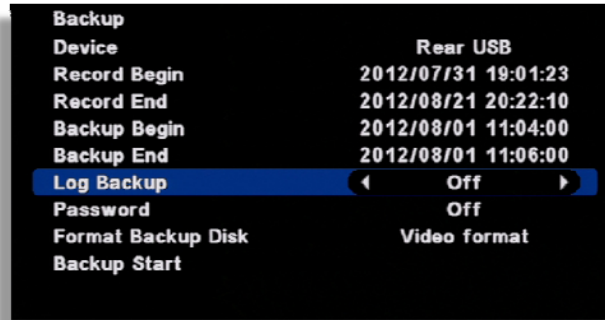

- Log Backup : The log file will be backup together.
- Password : Backup data can be protected by the password.
- Format Backup Disk : Select whether the viewer program will be backup together with data file.
 - Executable format : Viewer program will b backup together
 - Video Format : Only data file will be backup without viewer program

[9] Backup Start : The backup start after click 'OK'

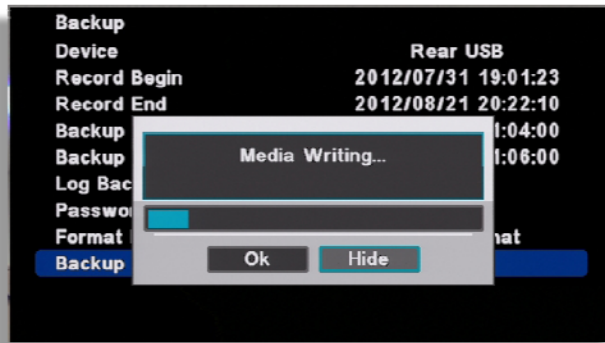

[10] If the backup is completed, you will see the below icon as a file in USB stick. If you click it, playback starts.



[11] How to use the viewer program(If you click the backup file, it runs automatically).

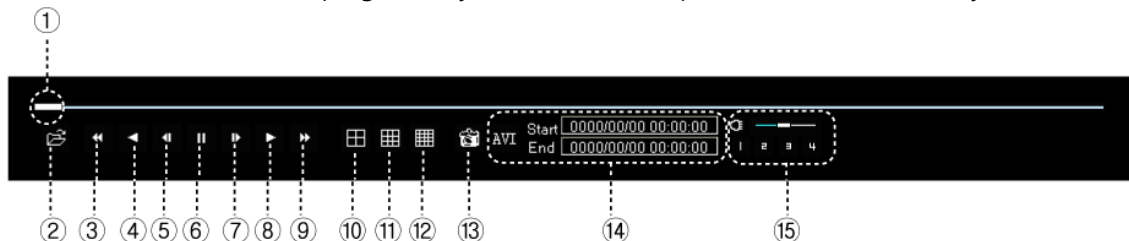

- ① Scroll bar : It shows the current location from the total playback volume.
- ② Open : To open the other backup file.
- ③ Fast reverse playback
- ④ Reverse playback
- ⑤ One step reverse playback
- ⑥ Pause
- ⑦ One step playback
- ⑧ Playback
- ⑨ Fast playback
- ⑩ 4 split screen
- ⑪ 9 split screen
- ⑫ 16 split screen
- ⑬ Current image capture
- ⑭ When you convert it to AVI . You can click the 'START' and 'END' time(circled space) during playback and if you click 'AVI', it converts to 'AVI' file.
- ⑮ If you click it, you can listen to the recorded audio of selected channel.

11. Mobile Viewing by iPhone

11-1 Install the program

Go to Apple Store website and search and download MPRMS. Then install the MPRMS.

11-2 Execute the program

When the installation is completed, the following icon is created.



Select the icon to execute.

11-3 Register the product information

Enter the network information to access the DVR with iPhone.

[1] Register

Execute the program in iPhone and click "New" for the new registration.

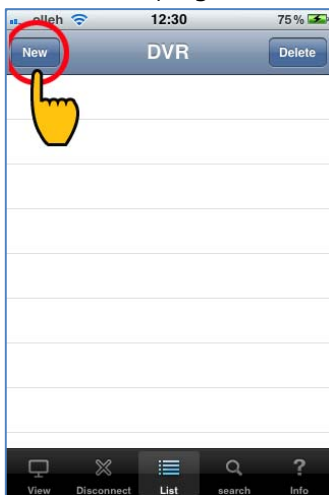

[2] Enter the Reg Name.



Any name is available to use for Reg. Name.

[3] Select the model name



If the item to be connected is a DVR, select DVR.

[4] Enter the DVR ID and Password.



⊙ DVR ID : Enter the ID registered in the DVR

⊙ Password : Enter the password registered in the DVR

(Note : You can check the ID and password in the DVR Setup Menu)

[5] Enter the DVR IP (Static IP user only)



Dynamic IP user doesn't enter the DVR IP.

(Note) The static IP indicates the IP address registered in DVR.

[6] Set DDNS IP (Dynamic IP user only)



Ⓒ Static IP user selects "OFF".

DDNS USE : OFF

Ⓒ Dynamic IP user selects "ON"

DDNS USE : ON

Ⓒ DDNS ID : Enter the DVR's unique "Web code".

(Note : Keep the DDNS IP and DDNS PORT at their default value.)

[7] Set DDNS IP (Dynamic IP user only)

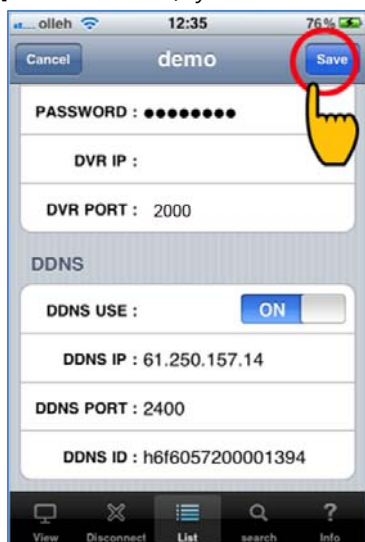

After setting all, press "ADD" to save.

11-4 Live monitoring

[1] Click the registered "DVR Name".

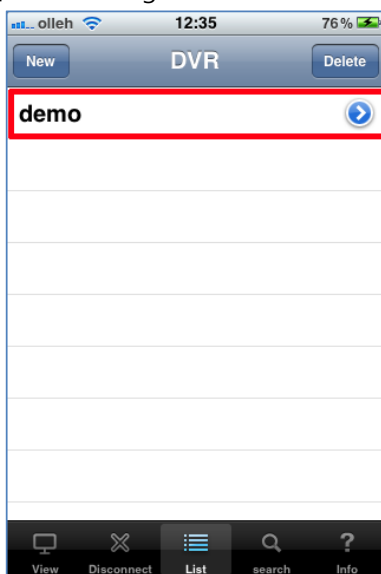

[2] Connect remotely



For a channel selection, click "CH SELECT" to select a number.

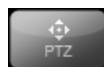

Click "PTZ" to control Pan/Tilt/Zoom



Off the information such as time, resolution, channel, etc. and display the video only.

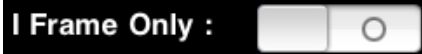

When selected, it transmits still images with certain intervals in case video streaming is interrupted due to the network load.

☞ See full screen : If you turn iPhone to one side, it's switched to full screen.
(Touch any part of the full screen to call the menu)

11-5 Search

Select "search" the icon below.



[1] Select Date/Time



After selecting a date, select "SEARCH".

[2] Search key operation

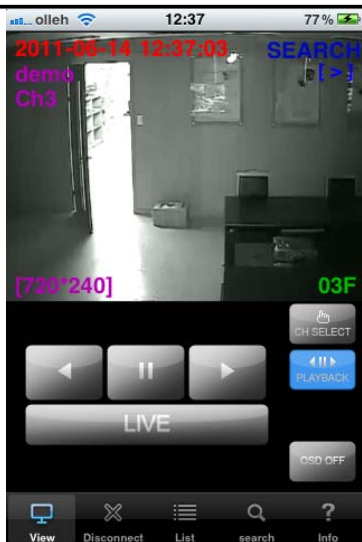

Play reverse

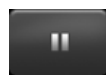

Pause



Play



Switch to Live

11-6 Relay out

Relay can be controlled remotely..

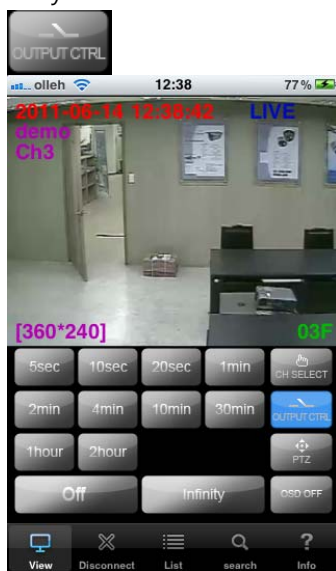

Time selection : Set the duration time of alarm output

Off : Alarm off

Infinity : Keep the alarm output continued

11-7 PTZ control

PTZ control is available on iPhone. The way how to control is the same with on CMS and DVR

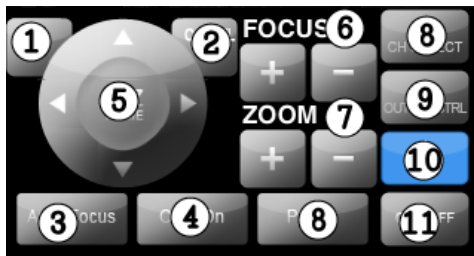

- (1) Select
- (2) Cancel
- (3) Automatic camera focus
- (4) Call the PTZ menu
- (5) Direction button
- (6) Camera focus control
- (7) Camera zoom control
- (8) Select the channel
- (9) Relay out button (A user can set relay out)
- (10) Select the PTZ menu
- (11) OSD display On/Off button for live screen

12. Mobile Viewing by Android phone

12-1 Install the program

To install the program on the Phone, execute the 'MARKET' program and download the 'MPRMS' to install. If the installation is completed, you will see the 'MPRMS' icon on the main SCREEN.

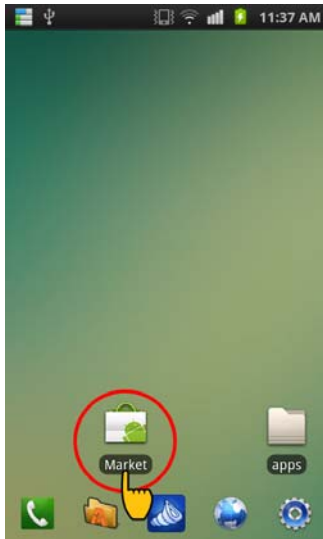

(1)

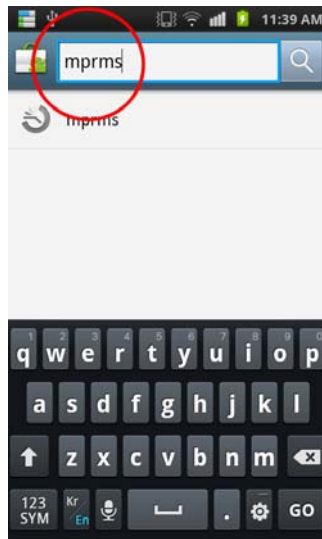

(2)



(3)

12-2 Execute program

Select "MPRMS" to execute the program.

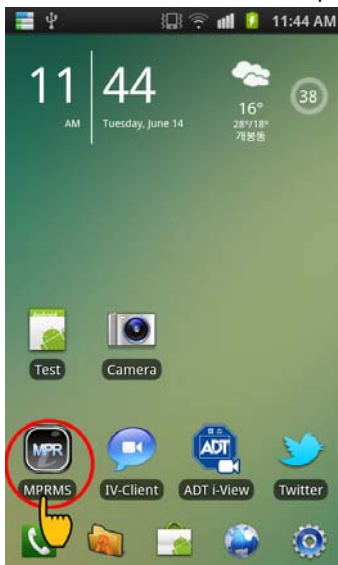

(Select the icon)

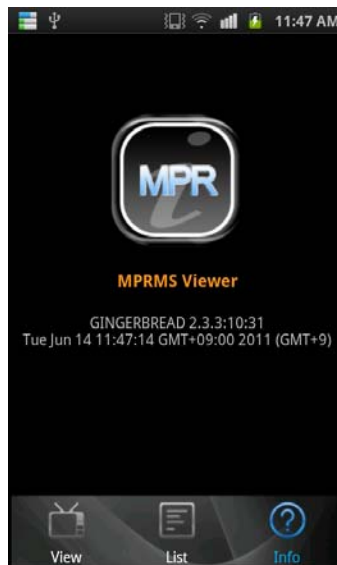

(Executed Program)

12-3 Register the product information

Register the product information for remote monitoring.

[1] Register

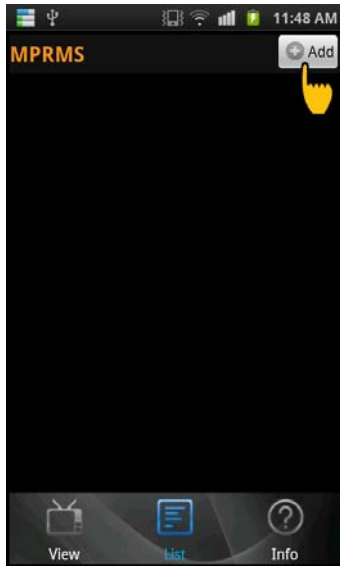

Select "Add" to start the registration.

[2] Enter the registration information

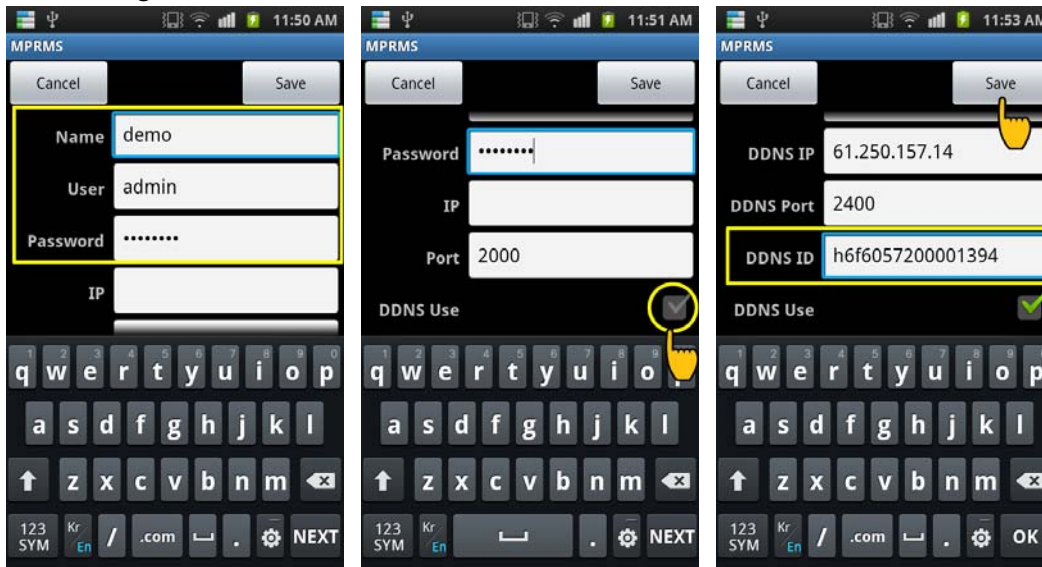

(1)

(2)

(3)

(1) Enter the name, Product ID(User) and Password.

Name : Enter any name you want.

User : Enter the "User ID" registered to the DVR.

Password : Enter the "Password" registered to the DVR.

(Note : "Menu" → "System" → "Password")

IP : This setting is only for static IP users.

(2) After selecting "DDNS use", enter the "Password, IP and Port".

(Note: Dynamic IP user only)

(3) You can check the DDNS ID from the DVR menu: 'Menu' → "System" → System Information.

Copy the 'WEBCODE' and enter it to DDNS ID and save it. (DDNS PORT is automatically changed as per the Webcode of DVR.)

12-4 Modify/Delete of Registered Information

If you want to modify or delete the registered information, select the triangle-shaped icon.

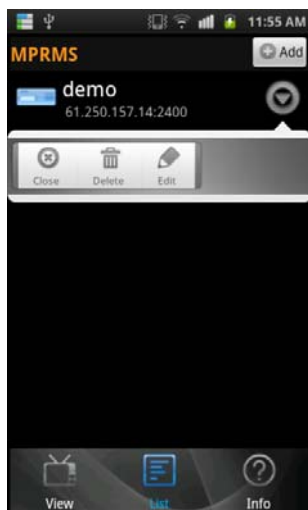

Select to edit the registered info.

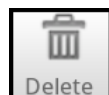

Select to delete the registered info.



Close TOOL menu (As a dual function, it ends the connection)

12-5 Remote connection

Select the registered list for connection. Once you click the registered device, it shows the brief information like the 1st picture below. If you click the red-colored background, detailed info. appears like the 2nd picture. Click OK to execute the monitoring program.

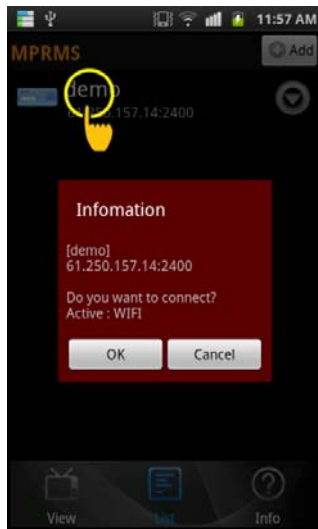

(Select the list)



(Detailed info.)

12-6 Live

Live shows the images taken from each camera in real time.

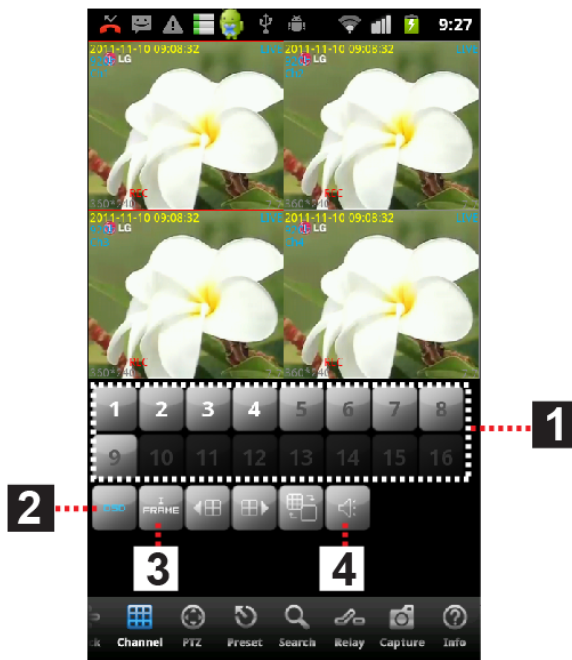

(1) Number : The screen no. currently displayed is shown with bold white. If you select a channel, the channel is displayed with full screen. (The channel no. could be different per model.)

(2) OSD : You can turn on or off the display for channel no., date, time, event, etc

(3) I frame : It transmits still images with certain intervals in case video streaming is interrupted due to network load.

(4) Audio listening : If you select a channel, you can listen the audio.

12-7 Multi-screen

Live monitoring by 4 split multi-screen is available.



(1) Move to previous 4ch split screen.

(Ex) When monitoring 16ch DVR, split screen of CH1/2/3/4 is switched into CH13/14/15/16.

(2) Move to next 4ch split screen

(Ex) When monitoring 16ch DVR, split screen of CH1/2/3/4 is switched into CH5/6/7/8.

(3) You can change one channel into another during 4 split monitoring.

(Step)

- 1) When monitoring 1/2/3/4, if you want to change CH1 into CH6, select CH1 at first.
- 2) Then, the screen is switched into CH1 full screen. This time, if you select CH6, then the screen is switched into CH6 full screen.
- 3) If you click "Multi-icon" like picture, the screen is switched into split screen of CH6/2/3/4.

12-8 Main menu

On the bottom line of screen, there is a main menu. Select the menu to change the function

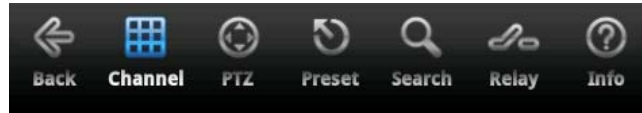

Go back to the previous step or close the monitoring program



Move to live mode (Channel change, 1 Frame and OSD display is available)



Go to PTZ mode



Go to PTZ preset mode



Go to search mode



Go to alarm mode



See the registered info.

12-9 PTZ

You can control the PTZ camera remotely.



(Select PTZ mode)



(PTZ mode screen)

- (1) Go to PTZ mode
Select the PTZ connected channel and click the PTZ button.
- (2) How to control PTZ



The PTZ camera moves to the selected direction.

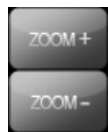

Zoom in/ out



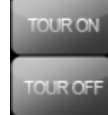

Focus adjustment

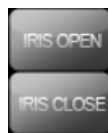

Touring operates according to the previously registered 'Preset' number

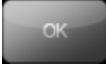
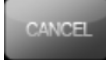

IRIS Open/ Close.

-  Call the PTZ menu
-  Auto Focus
-  OK button for PTZ OSD menu
-  Cancel or the upper menu on PTZ OSD menu

12-10 PTZ Preset

You can set the movement of PTZ camera previously and make the automatic PTZ movement.



(Select preset mode)

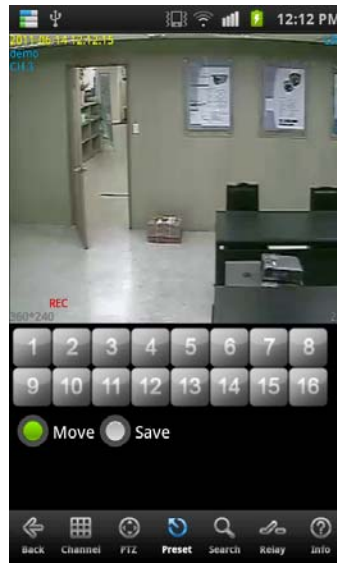

(Preset mode screen)

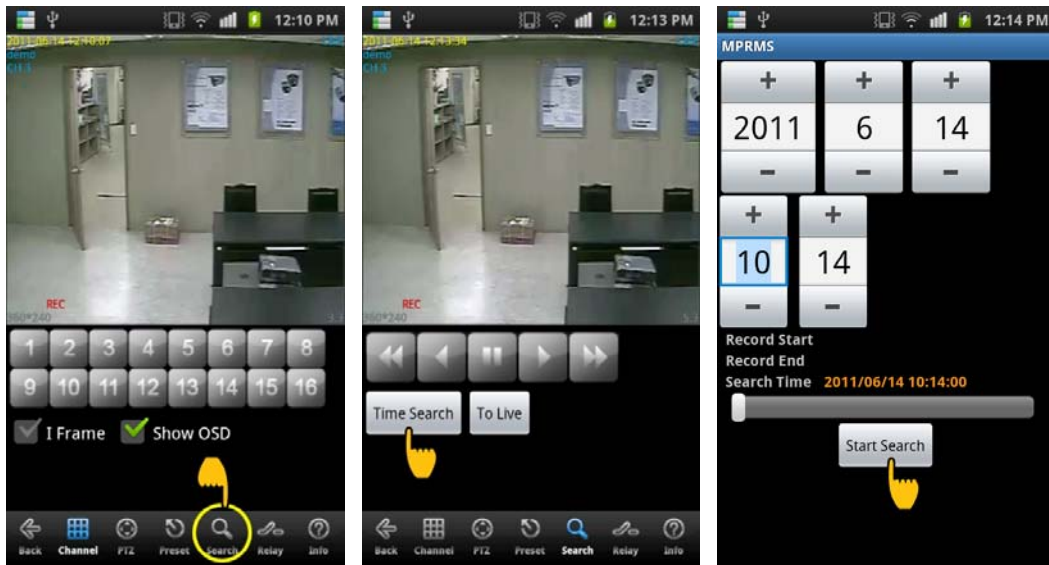

- (1) How to go to PTZ mode
Select the PTZ connected channel and click the Preset button.
- (2) How to operate Preset
 - Move: If you select "Move" and press a number, then the camera moves.
 - Save: If you select "Save" and press a number, then the current location is saved.

12-11 Search



(1. Select the search mode) (2. Select "Time Search") (3. Select the date and time)

- (1) Select the search mode
- (2) Select "Time Search": Select "Time Search" to enter the search conditions.
(Note: Select "To Live" to return to the live mode during the search.)
- (3) Enter the date and time: Select the date and time and click "Start Search" for search.

-  Fast reverse playback
-  Reverse playback
-  Pause
-  Playback
-  Fast playback

12-12 Relay Out

Relay can be controlled remotely.

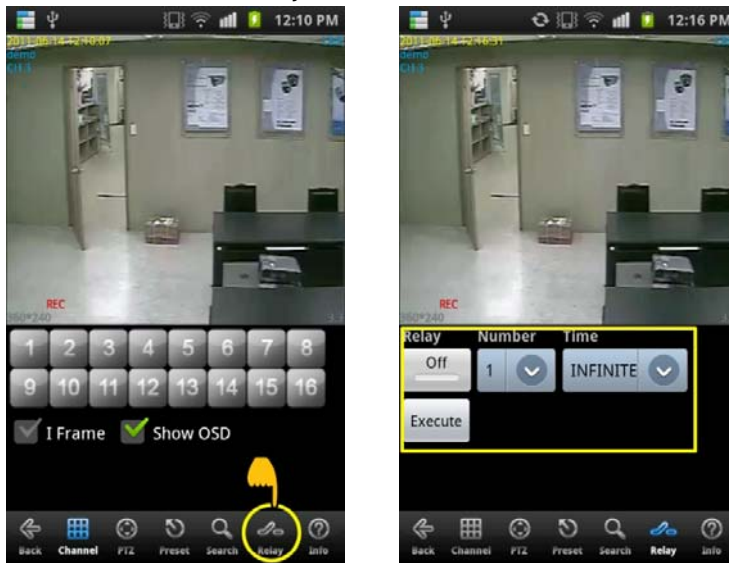

- (1) Relay : Select On or Off
- (2) Number : Select the relay number.
- (3) Time : Select the duration time.
- (4) Execute : Make the alarm output work

12-13 Information display

It shows the information of current connection.

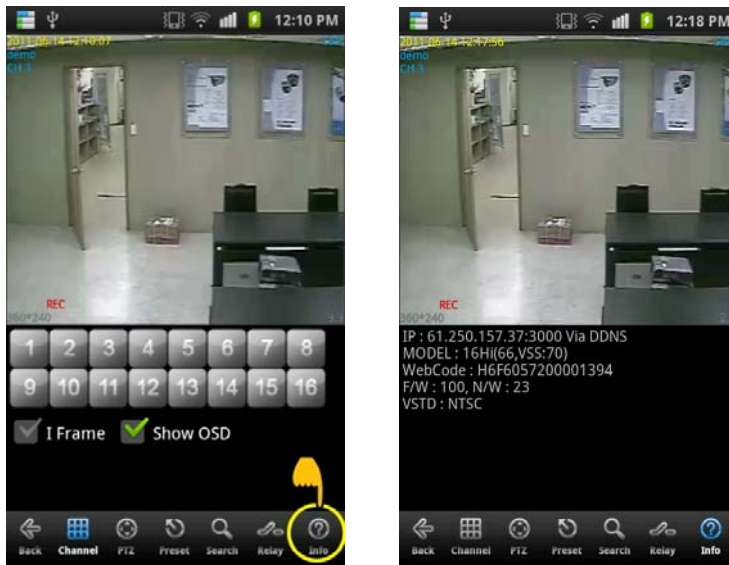

(Select info)

(Display the connection info)

[Display Info]

Below is the example for an explanation.

- IP : 61.250.157.37 : 2000 Via DDNS ← Connected IP information.
- MODEL : 16CH(63,xxx xxx:0) ← 16Ch model
- Webcode : H6F6057200001394 ← Product ID(Webcode).
- F/W : 84, N/W:21 ← F/W and network version.
- VSTD : NTSC ← VIDEO standard.

12-14 End the connection



(Select the back button)



(Select the Yes button)

There are several ways to finish the program.

1. If you click 'BACK', it asks like "Do you want to disconnect?" Then, you may click Yes.
2. Or you may just press close button on the phone.

13. Specification

Specification		4ch	9ch	16ch
Operating System		Embedded Linux		
Video Algorithm		H.264		
Audio Algorithm		G723.1		
Video Method		NTSC/PAL		
Video Input/Output	Video Input	4	9	16
	Video Output	Composite(1), Spot(1), VGA(1), HDMI(1)		
	Output Mode	CCTV, VGA, HDMI Monitor		
Live		Real-time Live		
Split Mode		1,4	1,4,6,9	1,4,6,9,13,16
Record Resolution	NTSC	480x240, 960x240, 960x480		
	PAL	480x288, 960x288, 960x576		
Record Frame	960H	120/100fps	240/200fps	240/200fps
	D1	120/100fps	240/200fps	240/200fps
Record Mode		Emergency, Schedule, Sensor, Motion, Pre&Post record		
Search	Search Mode	Calendar, Data/Time, Event, Go to First, Go to Last		
	Play Speed	x1, x2, x4, x8, x16, x32		
Audio	Input/Output	4/1		
	Volume	Able to adjust volume		
Input Sensor/ Output Alarm		4/1		
Port	RS-232	Keyboard Control		
	RS-485	PTZ Control		
	LAN	10/100/1000 Base-Tx Ethernet(RJ-45) - Fixed IP, DHCP & DDNS		
Network Control		Video Dual-Stream (Local Recording & Network Transmission)		
Remote Access	Software	ADTeye		
	IE	http://www.adtcpascctv.net.com		
Backup Device	Internal	ODD Backup (Option)		
	External	USB, E-SATA External Storage		
HDD		2xSATA HDD or 1xSATA HDD & 1xODD		
System Operation		Front Button, USB Mouse, IR Remote Controller, Keyboard(Optional)		
Others	Support Multi-languages			
	Able to enter Hangul for camera name			
	Able to control as moves in controlling pan-tilt			
	Able to install backup viewer program and to convert into AVI			
Power Consumption		12.2W	14W	16W
Power		Adaptor 12V 5A		
Temperature		0°C ~ 40°C		
Dimension		360mm(W) X 66mm(H) X358.2mm(D)		
Weight		4.1kg		

